

Synergy™ HTX

Operator's Manual



Synergy HTX

Multi-Mode Microplate Reader Operator's Guide

July 2014

© 2014

Part Number 1341000

Revision A

BioTek[®] Instruments, Inc.

Notices

BioTek® Instruments, Inc.

Highland Park, P.O. Box 998

Winooski, Vermont 05404-0998 USA

All Rights Reserved

© 2014, BioTek® Instruments, Incorporated. No part of this publication may be reproduced, transcribed, or transmitted in any form, or by any means electronic or mechanical, including photocopying and recording, for any purpose other than the purchaser's use without written permission of BioTek Instruments, Inc.

Trademarks

BioTek® is a registered trademark, and Synergy™, Gen5™, BioCell™, 4-Zone™ and BioStack™ are trademarks of BioTek Instruments, Inc. Harta™ is a trademark of Harta Instruments.

Microsoft®, Windows®, and Excel® are either registered trademarks or trademarks of Microsoft Corporation in the United States and/or other countries.

All other trademarks are the property of their respective holders.

Restrictions and Liabilities

Information in this document is subject to change and does not represent a commitment by BioTek Instruments, Inc. Changes made to the information in this document will be incorporated in new editions of the publication. No responsibility is assumed by BioTek for the use or reliability of software or equipment that is not supplied by BioTek or its affiliated dealers.

Contents

Contact Information	v
Customer Service and Sales.....	v
Global Service and Support.....	v
Document Conventions.....	vii
Revision History	viii
Intended Use Statement	ix
Quality Control	ix
Warranty and Product Registration	ix
Repackaging and Shipping	x
Warnings.....	x
Hazards.....	x
Precautions	xii
CE Mark	xiii
Directive 2004/108/EC: Electromagnetic Compatibility	xiii
Directive 2006/95/EC Low Voltage (Safety).....	xiii
Directive 2002/96/EC: Waste Electrical and Electronic Equipment	xiv
Directive 98/79/EC: In Vitro Diagnostics (if labeled for this use)	xiv
Electromagnetic Interference and Susceptibility	xiv
USA FCC CLASS A	xiv
Canadian Department of Communications Class A.....	xiv
User Safety	xv
Safety Symbols	xvi
Introduction	1
Synergy HTX Multi-Mode Microplate Reader.....	2
Package Contents	3
Optional Accessories	4
Product Support & Service	5
Technical Assistance Center (TAC)	5
Returning Instruments for Service/Repair	5
Applications Support.....	5
Installation.....	7
Product Registration	8
1: Unpack and Inspect the Reader	8
2: Remove the Shipping Panel	10
3: Remove the Microplate Carrier Shipping Screw.....	11
4: Install the Fluorescence Lamp Assembly.....	12

5: Select an Appropriate Location.....	13
6: Connect the Power Supply.....	14
7: Unpack and Inspect the Dispense Module.....	15
8: Install the Dispense Module.....	18
Record Syringe Calibration Values.....	18
Install the Dispenser.....	18
9: Connect the Host Computer	20
10: Install Gen5 Software	20
11: Turn on the Reader	20
12: Establish Communication	21
13: Set the Dispenser Calibration Values.....	22
14: Run a System Test	23
15: Test the Injector System.....	24
Operational/Performance Qualification	26
Repackaging and Shipping Instructions	26
Getting Started.....	31
Key Components	32
Power Switch, Carrier Eject Button, Microplate Carrier	32
Lamp Assembly and Filter Wheel Access	33
Excitation and Emission Filter Wheels.....	34
Installing the Time-Resolved Fluorescence Cartridge	37
Configuring the System for Luminescence Measurements..	38
The External Dispense Module.....	39
Gen5 Software	41
Viewing/Updating the Filter and Wavelengths Tables	42
Creating Protocols and Experiments	43
Controlling the Dispense Module.....	45
Recommendations for Optimum Performance.....	48
Incubation and Partial Plates.....	49
Preventive Maintenance	51
Recommended Maintenance Schedule.....	52
Overview	52
Daily Cleaning for the Dispense Module	52
Recommended Maintenance Schedule	53
Warnings and Precautions	54
Cleaning Exposed Surfaces.....	55
Inspect/Clean Excitation and Emission Filters.....	56
Flush/Purge the Fluid Path	57
Running a Dispense Protocol (Optional)	58
Empty/Clean the Tip Priming Trough	59
Clean the Priming Plate.....	59
Clean the Internal Components.....	60

Required Materials.....	61
Removing the Reader's Shroud.....	62
Removing the Internal Tubes and Injector Heads	64
Cleaning the Internal Tubes and Injector Heads.....	67
Cleaning the Optical Probes	68
Cleaning the Reader's Internal Surface.....	76
Reassembling the Components.....	77
Performance Check.....	79
As-Needed Maintenance	81
Purpose.....	82
Required Materials	83
Procedure for Models without Injectors	84
Routine Procedure for Models with Injectors	85
Clean Exposed Surfaces	85
Decontaminate the Fluid Lines.....	86
Rinse the Fluid Lines	87
Clean the Internal Tubing and Injector Heads.....	87
Clean the Tip Priming Trough and Priming Plate.....	88
Alternate Procedure for Models with Injectors	89
Instrument Qualification	91
Overview	92
IQ/OQ/PQ.....	92
Recommended Qualification Schedule	94
System Test.....	95
Absorbance Plate Test	100
Test Plate Certificates	100
Define Absorbance Test Plate Parameters	100
Run the Absorbance Plate Test	101
Results and Troubleshooting Tips.....	104
Luminescence Tests	105
Harta Plate Test	106
Gen5 Protocol Reading Parameters	107
Troubleshooting	109
Absorbance Liquid Tests	109
Absorbance Liquid Test 1.....	110
Absorbance Liquid Test 2.....	112
Absorbance Liquid Test 3 (optional)	114
Fluorescence Tests.....	116
Required Materials.....	117
Test Solutions.....	118
Procedure	119
Results Analysis	119

Troubleshooting	120
Pipette Map	121
Gen5 Protocol Reading Parameters	122
Fluorescence Tests Using Methylumbelliferone	126
Dispense Module Tests	131
Required Materials.....	132
Alternate Test Solutions	133
Procedure for Models <u>with</u> Absorbance Capabilities	133
Procedure for Models <u>without</u> Absorbance Capabilities	135
Results Analysis	136
Gen5 Test Protocols for Models <u>with</u> Absorbance Capabilities	137
Gen5 Test Protocols for Models <u>without</u> Absorbance Capabilities	139
Create the Dispense Protocols	139
Specifications	143
General Specifications	144
Absorbance Specifications	145
Fluorescence Specifications	147
Luminescence Specifications.....	148
Models with Injectors	149
Error Codes	151
Error Codes Overview	152
Contact Info: BioTek Service/TAC	152
Error Codes	153

Contact Information

Customer Service and Sales

Internet: www.biotek.com
 Phone: 888-451-5171 (toll-free in the U.S.)
 802-655-4740 (outside the U.S.)
 Fax: 802-655-7941
 Email: customercare@biotek.com

Global Service and Support

BioTek instrument service and repair is available worldwide at one of BioTek's International Service Centers and in the field at your location. For technical assistance, contact the Technical Assistance Center (TAC) at BioTek World Headquarters US. To arrange for service or repair of your instrument, contact the office nearest you.

BioTek World Headquarters US	BioTek China
Mailing Address: PO Box 998, Highland Park Winooski, VT 05404-0998 United States Service Shipping Address: 15 Tigan Street Winooski, VT 05404	Room 304, Tower D Ocean International Center 62 Middle 4th East Ring Road Chaoyang District Beijing 100025 P.R. China
Phone: (800) 242-4685 Outside US: (802) 655-4740 Fax: (802) 654-0638	Phone: +86 (10) 85865569 Fax: +86 (10) 85861829
Email: TAC@biotek.com Website: www.biotek.com	Email: infochina@biotek.com Website: www.biotekchina.com.cn

BioTek Germany Service Center & European Coordination Center	BioTek Instruments SAS <i>Bureau de liaison France</i>
Kocherwaldstrasse 34 D-74177 Bad Friedrichshall Germany	50 avenue d'Alsace 68025 Colmar Cedex France
Phone: +49 (0) 71369680 Fax: +49 (0) 7136968111	Phone: +33 (3) 89206329 Fax: +33 (3) 89204379
Email: info@biotek.de Website: www.biotek.de	Email: info@biotek.fr Website: www.biotek.fr



BioTek India	BioTek Singapore
Unit 223, Linkway Estate New Link Road, Malad West Mumbai 400064	20 Science Park Road #01-08A Teletech Park Singapore 117674

India	
Phone: +91 (22) 28789966 Fax: +91 (22) 28759944	Phone: +65 65922100 Fax: +65 67772611
Email: biotek@biotek.in Website: www.biotek.in	Email: singapore@biotek.com Website: www.biotek.com

BioTek South Korea	BioTek Switzerland
3F, Gyungnam building, 830-48 Yeoksam-dong, Gangnam-gu Seoul, South Korea (135-936)	Zentrum Fanhöfli 8 6014 Luzern Switzerland
Phone: +82 (0) 2-562-4740 Fax: +82 (0) 2-562-4750	Phone: +41 (41) 2504060 Fax: +41 (41) 2505064
Email: korea@biotek.com Website: www.biotekinstruments.co.kr	Email: info@biotek.ch Website: www.biotek.ch

BioTek United Kingdom (UK)
6 Bull Street Potton, Bedfordshire SG19 2NR United Kingdom
Phone: +44 (1767) 262000 Fax: +44 (1767) 262330
Email: info@biotek.uk.com Website: www.biotek.uk.com

Document Conventions

	This icon calls attention to important safety notes.
Warning!	A Warning indicates the potential for bodily harm and tells you how to avoid the problem.
Caution	A Caution indicates potential damage to the instrument and tells you how to avoid the problem.
Note:	Bold text is primarily used for emphasis.
<i>italic</i>	Topics that apply only to specific Synergy HTX models are preceded by a notice in italics, for example: <i>Applies only to Synergy HTX models with injectors.</i>
	This icon calls attention to important information .

Revision History

Rev	Date	Changes
A	7/2014	Initial release

Intended Use Statement

- The Synergy HTX is a single-channel absorbance, fluorescence, and luminescence microplate reader that uses a dual-optics design to perform measurements of samples in a microplate format. The performance characteristics of the data reduction software have not been established with any laboratory diagnostic assay. The user must evaluate this instrument and Gen5 software in conjunction with their specific assay(s). This evaluation must include the confirmation that performance characteristics for the specific assay(s) are met.
- If the instrument has an “IVD” label, it may be used for clinical and non-clinical purposes, including research and development. If there is no such label, the instrument may be used only for research and development or other non-clinical purposes.

Quality Control

It is considered good laboratory practice to run laboratory samples according to instructions and specific recommendations included in the assay package insert for the test to be conducted. Failure to conduct Quality Control checks could result in erroneous test data.

Warranty and Product Registration

Take a moment to review the Warranty information that shipped with your product. Please also register your product with BioTek to ensure that you receive important information and updates about the product(s) you have purchased. You can register online through the Customer Resource Center at www.biotek.com or by calling 888/451-5171 or 802/655-4740.

Repackaging and Shipping



If you need to ship the instrument to BioTek for service or repair, contact BioTek for a service authorization number, and be sure to use the original packing materials. Other forms of commercially available packaging are not recommended and can **void the warranty**. If the original packing materials have been damaged or lost, contact BioTek for replacement packing.

Warnings



Operate the instrument on a level, stable surface away from excessive humidity.

Bright sunlight or strong incandescent light can reduce the linear performance range of the instrument.

Measurement values may be affected by extraneous particles (such as dust) in the microplate wells. A clean work area is necessary to ensure accurate readings.

When operated in a safe environment according to the instructions in this document, there are no known hazards associated with the instrument. However, the operator should be aware of certain situations that could result in serious injury; these may vary depending on the instrument model. See **Hazards** and **Precautions**.

Hazards

The following hazard warnings are provided to help avoid injury:



Warning! Internal Voltage. Always turn off the power switch and unplug the power supply before cleaning the outer surface of the instrument or removing its top case.



Warning! Power Rating. The instrument's power supply or power cord must be connected to a power receptacle that provides voltage and current within the specified rating for the system. Use of an incompatible power receptacle may produce electrical shock and fire hazards.

Warning! Electrical Grounding. Never use a plug adapter to connect primary power to the external power supply. Use of an adapter disconnects the utility ground, creating a severe shock hazard. Always connect the power cord directly to an appropriate receptacle with a functional ground.



Warning! Service. Only qualified technical personnel should perform service procedures on internal components.

Warning! Accessories. Only accessories that meet the manufacturer's specifications shall be used with the instrument.

Warning! The instrument weighs approximately 38 pounds (17 kg). Use two people when lifting and carrying the instrument.

Warning! Lubricants. Do not apply lubricants to the microplate carrier or carrier track. Lubricant on the carrier mechanism or components in the carrier compartment will attract dust and other particles, which may obstruct the carrier path and cause the instrument to produce an error.

Warning! Liquids. Avoid spilling liquids on the instrument; fluid seepage into internal components creates a potential for shock hazard or instrument damage. If a spill occurs while a program is running, abort the program and turn the instrument off. Wipe up all spills immediately. Do not operate the instrument if internal components have been exposed to fluid.

Warning! Unspecified Use. Failure to operate this equipment according to the guidelines and safeguards specified in this manual could result in a hazardous condition.

Warning! Software Quality Control. The operator must follow the manufacturer's assay package insert when modifying software parameters and establishing reading, washing, or dispensing methods. **Failure to conduct quality control checks could result in erroneous test data.**

Warning! Reader Data Reduction Protocol. No limits are applied to the raw absorbance data. All information exported via computer control must be thoroughly analyzed by the operator.



Warning! Potential Biohazards. Some assays or specimens may pose a biohazard. Adequate safety precautions should be taken as outlined in the assay's package insert. This hazard is noted by the symbol shown here. Always wear safety glasses and appropriate protective equipment, such as chemically resistant rubber gloves and apron.



Warning! Hot Surface. The lamp assembly is hot when the instrument is turned on. Turn off the reader and allow the lamp to cool down before attempting replacement.



Warning! Pinch Hazard. Some areas of the dispense module can present pinch hazards when the instrument is operating. The module is marked with one of the symbols shown here. Keep hands/fingers clear of these areas when the instrument is operating.

Precautions

The following precautions are provided to help avoid damage to the instrument:



Caution: Service. The instrument should be serviced by BioTek authorized service personnel. Only qualified technical personnel should perform troubleshooting and service procedures on internal components.

Caution: Spare Parts. Only approved spare parts should be used for maintenance. The use of unapproved spare parts and accessories may result in a loss of warranty and potentially impair instrument performance or cause damage to the instrument.

Caution: Environmental Conditions. Do not expose the instrument to temperature extremes. For proper operation, ambient temperatures should remain within the range listed in the **Specifications** section. Performance may be adversely affected if temperatures fluctuate above or below this range. Storage temperature limits are broader.

Caution: Sodium Hypochlorite. Do not expose any part of the instrument to the recommended diluted sodium hypochlorite solution (bleach) for more than 20 minutes. Prolonged contact may damage the instrument surfaces. Be certain to rinse and thoroughly wipe all surfaces.

Caution: Power Supply. Only use the power supply shipped with the instrument. Operate this power supply within the range of line voltages listed on it.

Caution: Disposal. Dispose of the instrument according to Directive 2002/96/EC, “on waste electrical and electronic equipment (WEEE),” or local ordinances.

Caution: Warranty. Failure to follow preventive maintenance protocols may **void the warranty.**

Caution: Shipping Hardware. All shipping hardware must be removed before operating the instrument and reinstalled before repackaging the instrument for shipment.

Caution: Electromagnetic Environment. Per IEC 61326-2-6 it is the user’s responsibility to ensure that a compatible electromagnetic environment for this instrument is provided and maintained in order that the device will perform as intended.

Caution: Electromagnetic Compatibility. Do not use this device in close proximity to sources of strong electromagnetic radiation (e.g., unshielded intentional RF sources), because these may interfere with the proper operation.

CE Mark



Based on the testing described below and information contained herein, this instrument bears the CE mark

❖ See the Declaration of Conformity for more information.

Directive 2004/108/EC: Electromagnetic Compatibility

Emissions—Class A

The system has been type-tested by an independent, accredited testing laboratory and found to meet the requirements of EN 61326-1: Class A for Radiated Emissions and Line Conducted Emissions. Verification of compliance was conducted to the limits and methods of EN 55011 – (CISPR 11) Class A. In a domestic environment it may cause radio interference, in which case you may need to mitigate the interference.

Immunity

The system has been type-tested by an independent, accredited testing laboratory and found to meet the requirements of EN 61326-1 and EN 61326-2-6 for Immunity. Verification of compliance was conducted to the limits and methods of the following:

- EN 61000-4-2, Electrostatic Discharge
- EN 61000-4-3, Radiated EM Fields
- EN 61000-4-4, Electrical Fast Transient/Burst
- EN 61000-4-5, Surge Immunity
- EN 61000-4-6, Conducted Disturbances from RFI
- EN 61000-4-11, Voltage Dips, Short Interruptions and Variations

Directive 2006/95/EC Low Voltage (Safety)

The system has been type-tested by an independent testing laboratory and was found to meet the requirements of this Directive. Verification of compliance was conducted to the limits and methods of the following:

EN 61010-1. "Safety requirement for electrical equipment for measurement, control and laboratory use. Part 1, General requirements."

EN 61010-2-081, "Particular requirements for automatic and semi-automatic laboratory equipment for analysis and other purposes."

EN 61010-2-010, "Particular requirements for laboratory equipment for the heating of materials."

Directive 2002/96/EC: Waste Electrical and Electronic Equipment

Disposal Notice: Dispose of the instrument according to Directive 2002/96/EC, "on waste electrical and electronic equipment (WEEE)" or local ordinances.

Directive 98/79/EC: In Vitro Diagnostics (if labeled for this use)

- Product registration with competent authorities.
- Traceability to the U.S. National Institute of Standards and Technology (NIST).
- EN 61010-2-101, "Particular requirements for in vitro diagnostic (IVD) medical equipment."

Electromagnetic Interference and Susceptibility

USA FCC CLASS A

RADIO AND TELEVISION INTERFERENCE

Note: This equipment has been tested and found to comply with the limits for a Class A digital device, pursuant to Part 15 of the FCC Rules. These limits are designed to provide reasonable protection against harmful interference when the equipment is operated in a commercial environment. Like all similar equipment, this equipment generates, uses, and can radiate radio frequency energy and, if not installed and used in accordance with the instruction manual, may cause harmful interference to radio communications. Operation of this equipment in a residential area is likely to cause interference, in which case users will be required to correct the interference at their own expense.

In order to maintain compliance with FCC regulations, shielded cables must be used with this equipment. Operation with non-approved equipment or unshielded cables is likely to result in interference to radio and television reception.

Canadian Department of Communications Class A

This digital apparatus does not exceed Class A limits for radio emissions from digital apparatus set out in the Radio Interference Regulations of the Canadian Department of Communications.

Le present appareil numerique n'emet pas de bruits radioelectriques depassant les limites applicables aux appareils numerique de la Class A prescrites dans le Reglement sur le brouillage radioelectrique edicte par le ministere des Communications du Canada.

User Safety

This device has been type-tested by an independent laboratory and found to meet the requirements of the following:

- Underwriters Laboratories UL 61010-1, "Safety requirements for electrical equipment for measurement, control and laboratory use; Part 1: General requirements."
- Canadian Standards Association CAN/CSA C22.2 No. 61010-1, "Safety requirements for electrical equipment for measurement, control and laboratory use; Part 1: General requirements."
- EN 61010 Standards, see **CE Mark** starting on page xiii.

Safety Symbols

Some of these symbols appear on the instrument or accessories:

 <p>Alternating current Courant alternatif Wechselstrom Corriente alterna Corrente alternata</p>	 <p>Both direct and alternating current Courant continu et courant alternatif Gleich - und Wechselstrom Corriente continua y corriente alterna Corrente continua e corrente alternata</p>
 <p>Direct current Courant continu Gleichstrom Corriente continua Corrente continua</p>	 <p>Earth ground terminal Borne de terre Erde (Betriebserde) Borne de tierra Terra (di funzionamento)</p>
 <p>On (Supply) Marche (alimentation) Ein (Verbindung mit dem Netz) Conectado Chiuso</p>	 <p>Protective conductor terminal Borne de terre de protection Schutzleiteranschluss Borne de tierra de protección Terra di protezione</p>
 <p>Off (Supply) Arrêt (alimentation) Aus (Trennung vom Netz) Desconectado Aperto (sconnessione dalla rete di alimentazione)</p>	 <p>Caution (refer to accompanying documents) Attention (voir documents d'accompagnement) Achtung siehe Begleitpapiere Atención (vease los documentos incluidos) Attenzione, consultare la doc annessa</p>
 <p>Warning, risk of electric shock Attention, risque de choc électrique Gefährliche elektrische schlag Precaución, riesgo de sacudida eléctrica Attenzione, rischio di scossa elettrica</p>	 <p>Warning, risk of crushing or pinching Attention, risque d'écrasement et pincement Warnen, Gefahr des Zerquetschens und Klemmen</p>  <p>Precaución, riesgo del machacamiento y sejeción Attenzione, rischio di schiacciare ed intrappolarsi</p>
 <p>Warning, hot surface Attention, surface chaude Warnen, heiße Oberfläche Precaución, superficie caliente Attenzione, superficie calda</p>	 <p>Warning, potential biohazards Attention, risques biologiques potentiels Warnung! Moegliche biologische Giftstoffe Atención, riesgos biológicos Attenzione, rischio biologico</p>



In vitro diagnostic medical device
 Dispositif médical de diagnostic in vitro
 Medizinisches In-Vitro-Diagnostikum
 Dispositivo médico de diagnóstico in vitro
 Dispositivo medico diagnostico in vitro



Separate collection for electrical and electronic equipment
 Les équipements électriques et électroniques font l'objet d'une collecte sélective
 Getrennte Sammlung von Elektro- und Elektronikgeräten
 Recogida selectiva de aparatos eléctricos y electrónicos
 Raccolta separata delle apparecchiature elettriche ed elettroniche



Consult instructions for use
 Consulter la notice d'emploi
 Gebrauchsanweisung beachten
 Consultar las instrucciones de uso
 Consultare le istruzioni per uso

Chapter 1

Introduction

This chapter introduces the Synergy HTX, describes its key features, lists its package contents, and provides contact information for technical assistance.

Synergy HTX Multi-Mode Microplate Reader	2
Package Contents.....	3
Optional Accessories	4
Product Support & Service	5
Technical Assistance Center (TAC).....	5
Returning Instruments for Service/Repair.....	5
Applications Support	5

Synergy HTX Multi-Mode Microplate Reader

The Synergy HTX is a single-channel microplate reader available with absorbance, fluorescence, and luminescence detection. It is computer-controlled using BioTek's Gen5 software for all operations including data reduction and analysis. Synergy HTX is robot accessible and compatible with BioTek's BioStack Microplate Stacker.

When making fluorescence determinations, the Synergy HTX uses a tungsten quartz halogen lamp with interference filters for wavelength specificity in conjunction with a photomultiplier (PMT) tube detector. The Synergy HTX has both top and bottom probes for fluorescence measurements. The top probe can be adjusted vertically for the correct reading height, via Gen5's Read Height reading parameter (see **Chapter 3, Getting Started**).

Luminescence is measured by the low-noise PMT detector through an empty filter position in the Emission filter wheel. A filter can also be left in place if light filtering is necessary.

Absorbance measurements are made by switching to a xenon flash lamp and a monochromator for wavelength selection. The use of a xenon flash lamp allows for both UV and visible light absorbance measurements. The monochromator provides wavelength selection from 200 to 999 nm in 1-nm increments.

The Synergy HTX has a 4-Zone temperature control from 4°C over ambient to 50°C, controlled via a software-adjustable gradient. Internal plate shaking, with both linear and orbital modes, is supported to ensure that reagents are properly mixed prior to reading.

Both Synergy HTX models support the reading of 6-, 12-, 24-, 48-, 96-, and 384-well microplates with standard 128 x 86 mm geometry, as well as the BioTek Take3 and Take3 Trio Micro-Volume Plates. Absorbance mode reads plates up to 0.8" (20.3 mm) in height; fluorescence mode reads plates up to 1.25" (31.75 mm). Polymerase Chain Reaction (PCR) tubes up to 1.25" (31.75 mm) are also readable with the use of existing adapter plates.

For models with time-resolved fluorescence (TRF) capability, the TRF option allows measurements by using the xenon flash light source in conjunction with the PMT measurement detector. A special cartridge installed in the Excitation filter wheel location is required.

Models with injectors support dual-reagent dispensing to 6-, 12-, 24-, 48-, 96-, and 384-well microplates with standard 128 x 86 mm geometry. An external dispense module pumps fluid from the supply bottles to the two injectors located inside the instrument. Both injectors are positioned directly above the bottom probe, and fluid is injected into one well at a time.

Package Contents

❖ Part numbers and package contents are subject to change. Contact BioTek Customer Care with any questions.

Item	Part #
<i>Synergy HTX Operator's Manual</i>	1341000
Power supply	76061
Power cord set (specific to installation environment):	
Europe (Schuko)	75010
USA/International	75011
United Kingdom	75012
Australia/New Zealand	75013
RS-232 serial cable	75034
USB cable	75108
with USB Driver Software	7090204
Wrench	7772028
Fluorescence lamp assembly* (Note: The replacement lamp assembly is PN 7080500)	7080501
Filter "plugs" (2) (also referred to as "dummy filters" or "blanks")*	7082073
Plastic storage bag and fastener strips	—
Time-Resolved Fluorescence cartridge assembly ("T" models only)	7090523
Models with injectors, an external dispense module (packed separately), with the following accessories:	
Outlet tubes (2, plus 2 spare) from dispense module to instrument	7082120
Inlet tubes (2) from supply bottles to syringe drives	7082121
250 µl syringes (2)	7083000
Syringe thumbscrews (2)	19511
Priming plate	7132158
Injector tip priming trough	1342017
Dispense module communication cable	75107
Dispense module front cover	7082137
Supply bottles (2, 30 mL)	7122609
Supply bottle holder assemblies (2)	7090564
Injector tip cleaning stylus and plastic storage bag	2872304

* *If applicable to your reader model.*

Optional Accessories

❖ Accessory availability and part numbers are subject to change. Contact BioTek Customer Care with questions or visit www.biotek.com and use the Accessories search tool.

Item	Part #
7-filter Absorbance Test Plate	7260522
Fluorescence Test Plate	7092092
Product Qualification (IQ-OQ-PQ) package	1340508
PCR Tube Adapter Plates	6002072 and 6002076
Terasaki Adapter Plate	7330531
Take3 Micro-Volume Plate	TAKE3
Take3 Trio Micro-Volume Plate	Take3Trio
BioCell Quartz Vessel and Adapter Plate	7272051/7270512
Additional Fluorescence Filters; contact BioTek for part numbers and availability	
The Synergy HTX is compatible with the BioStack Microplate Stacker. Contact BioTek or visit our website to learn more.	

For Use with Liquid Tests (see Chapter 5)	Part #
Absorbance Liquid Test Solutions:	
BioTek Wetting Agent Solution	7773002
BioTek QC Check Solution #1	
25 mL	7120779
125 mL	7120782
Dispense Module Liquid Test Solution:	
BioTek Green Test Dye	7773003
BioTek Blue Test Dye	7773001
BioTek QC (Yellow) Test Dye	7120782
Individual Fluorescence Liquid Test Solutions:	
Sodium Fluorescein Powder	98155
Liquid Test Kit using Sodium Fluorescein	7160013
Liquid Test Kit using Methylumbelliferone ("MUB")	7160012

Product Support & Service

Technical Assistance Center (TAC)

If your instrument(s) or software fails to function properly, if you have questions about how to use or maintain our products, or if you need to send an instrument to BioTek for service or repair, please contact our Technical Assistance Center. BioTek's "TAC" is open from 8:30 AM to 5:30 PM (EST), Monday through Friday, excluding standard U.S. holidays. You can send a fax or an e-mail any time. You can also request technical assistance via our website: **www.biotek.com**.

Phone: (800) 242-4685 or
(802) 655-4740

Fax: (802) 654-0638

E-Mail: tac@biotek.com

Web: www.biotek.com

Please be prepared to provide the following information:

- Your name and company information, along with a daytime phone or fax number, and/or an e-mail address
- The product name, model, and serial number
- The onboard software part number and version (available through Gen5 at **System > Instrument Configuration > Get Basecode Information**)
- Gen5 software version information (**Help > About Gen5**)
- For troubleshooting assistance or instruments needing repair, the specific steps that produce your problem and any error codes displayed in Gen5 (see also **Appendix C, Error Codes**)
- A text file of the diagnostic history of the instrument (available via Gen5 by selecting **System > Diagnostics > History**, then selecting the appropriate file and clicking **Export**)

Returning Instruments for Service/Repair

If you need to return an instrument to BioTek for service or repair, please contact the TAC for a service authorization number *before* shipping the instrument. Repackage the instrument properly (see **Chapter 2, Installation**), write the number on the shipping box, and ship to BioTek.

Applications Support

BioTek's fully equipped Application Laboratory provides our on-staff scientists with the means to assist you with the integration of our instrumentation and software with your unique scientific applications. If you are having difficulty with optimizing fluorescence sensitivity or integrating a unique data reduction transformation, or you are just looking for a recommendation on an appropriate fluorophore, contact us.

Phone: (888) 451-5171

E-Mail: applications@biotek.com

Chapter 2

Installation

This chapter includes instructions for unpacking and setting up the Synergy HTX and, if applicable, the external dispense module. Instructions are also included for repackaging the reader and dispense module for shipment.

Product Registration	8
1: Unpack and Inspect the Reader	8
2: Remove the Shipping Panel	10
3: Remove the Microplate Carrier Shipping Screw	11
4: Install the Fluorescence Lamp Assembly	12
5: Select an Appropriate Location	13
6: Connect the Power Supply	14
7: Unpack and Inspect the Dispense Module	15
8: Install the Dispense Module	18
9: Connect the Host Computer	20
10: Install Gen5 Software.....	20
11: Turn on the Reader.....	20
12: Establish Communication	21
13: Set the Dispenser Calibration Values	22
14: Run a System Test	23
15: Test the Injector System	24
Operational/Performance Qualification.....	26
Repackaging and Shipping Instructions	26

Product Registration

Please register your product with BioTek to ensure that you receive important information and updates about the products you have purchased. Contact the Customer Resource Center (CRC) at www.biotek.com or by calling 888-451-5171 or 802-655-4740.

1: Unpack and Inspect the Reader



Important! Save all packaging materials. If you need to ship the reader to BioTek for repair or replacement, you must use the original materials. Using other forms of commercially available packaging, or failing to follow the repackaging instructions, may **void your warranty**. Improper packaging that results in damage to the instrument may lead to additional charges.

During the unpacking process, inspect the packaging, reader, and accessories for shipping damage. If the reader is damaged, notify the carrier and your BioTek representative. Keep the shipping boxes and the packaging materials for the carrier's inspection. BioTek will arrange for repair or replacement of your reader immediately.

1. Open the outer shipping box. Remove the foam blocks to access the inner box.
2. Carefully open the inner shipping box. Remove the accessories box and set it aside. Remove the vertical supports.

❖ **Warning!** The instrument weighs approximately 38 pounds (17 kg). Use two people when lifting and carrying the instrument.

3. The Synergy HTX is attached to a shipping panel that has two handles for lifting. Locate and grasp the handles. Carefully lift the reader out of the box and place it on a level surface. Remove the protective plastic bag.
4. Place all packing material back into the shipping box for reuse if the reader needs to be shipped again.

❖ See **Package Contents** in Chapter 1 for assistance with identifying the contents of the accessories box.

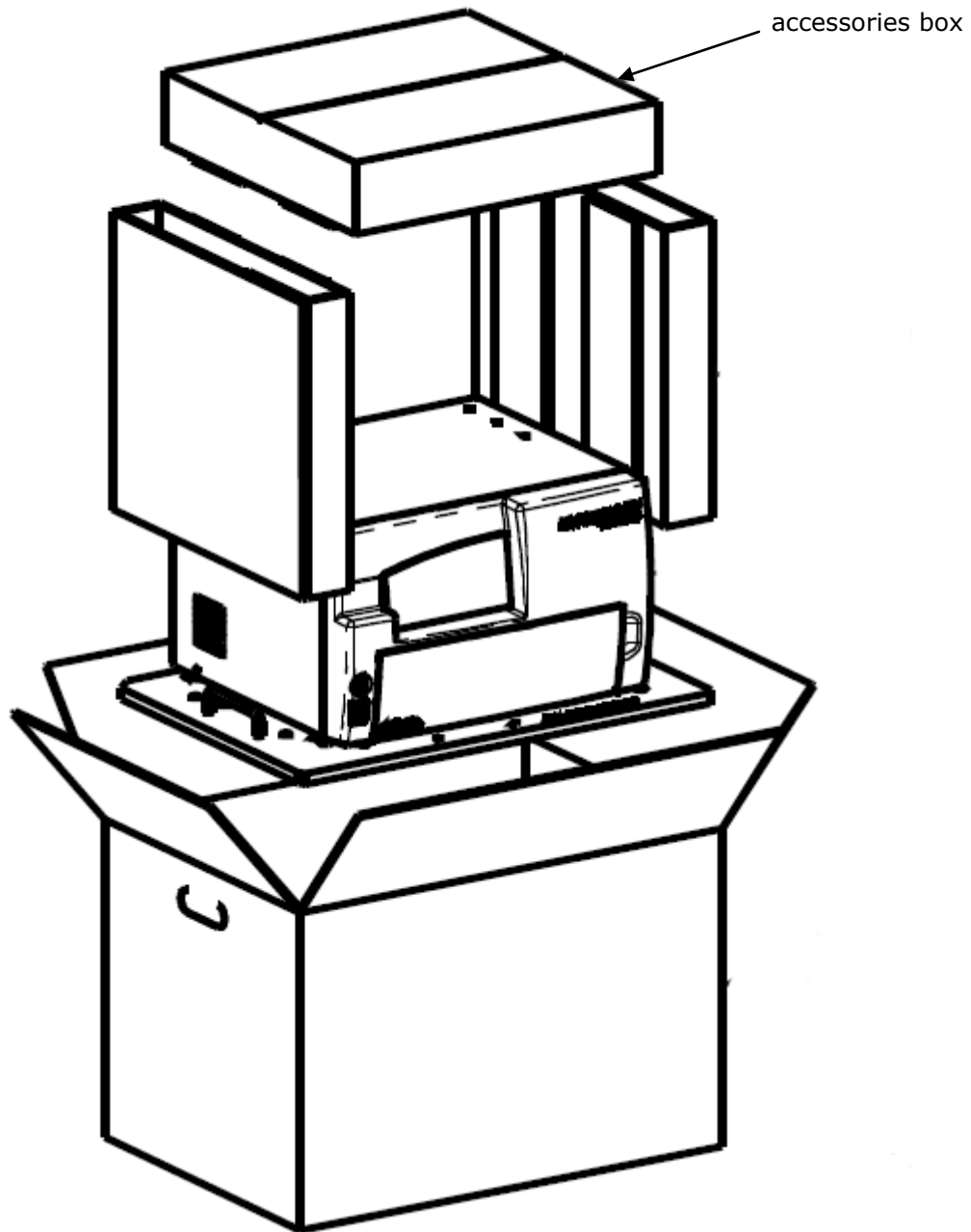

Figure 1: Unpacking the reader

2: Remove the Shipping Panel

1. Carefully tip the reader onto its back.
2. Using a screwdriver, remove the four screws and washers attaching the shipping panel to the bottom of the reader. See **Figure 2** on the next page.
3. Carefully set the reader upright.
4. Locate the supplied plastic tool storage pocket. Place the screws and washers inside the bag. Use the supplied fastener strips to attach the pocket to the back of the reader for storage. Do not block any air vents. See **Figure 2** on the next page.
5. Place the panel back into the inner shipping box for storage.



Important: Reattach the shipping panel before repackaging the Synergy HTX for shipment.

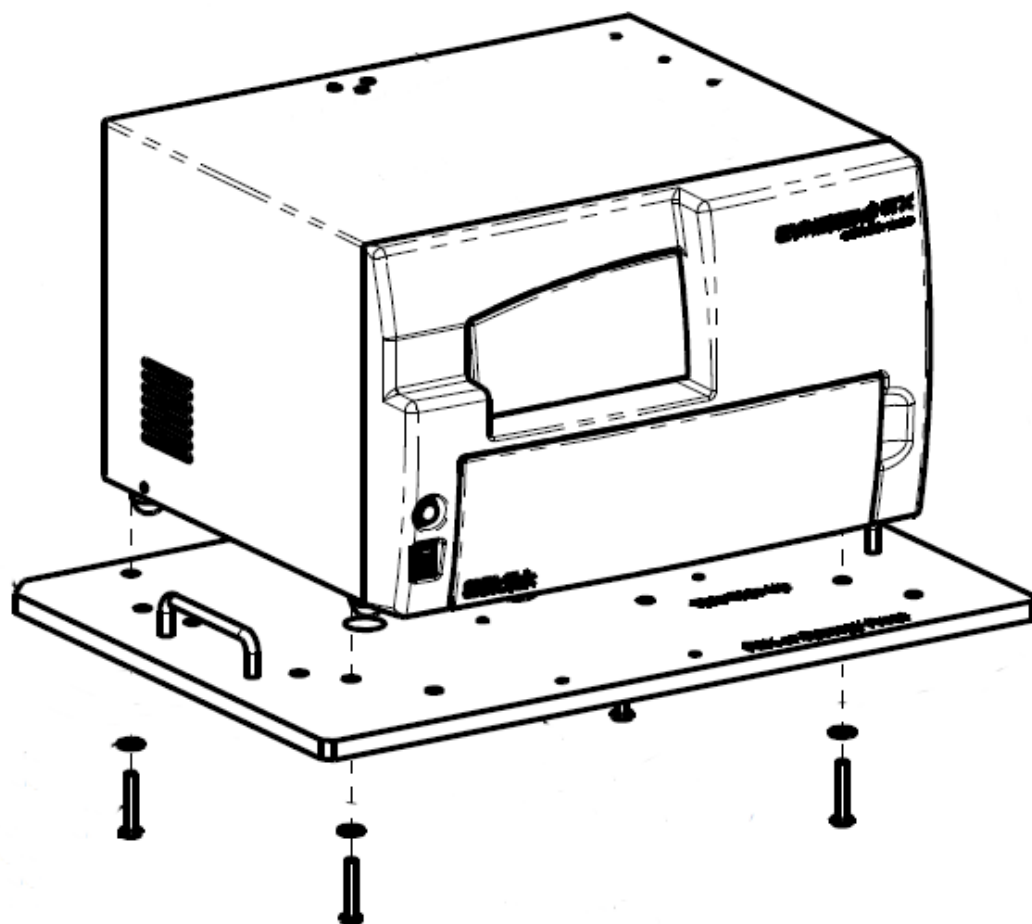

Figure 2: Removing the shipping panel

3: Remove the Microplate Carrier Shipping Bolt



Important: Remove the microplate carrier shipping bolt before turning on the Synergy HTX.

1. Pull down the microplate loading door on the front of the reader.
2. Using the supplied wrench, remove the carrier shipping bolt with its o-ring and warning tag.

3. Store the wrench, bolt, o-ring, and tag in a safe place, in case you need to ship the instrument back to BioTek.

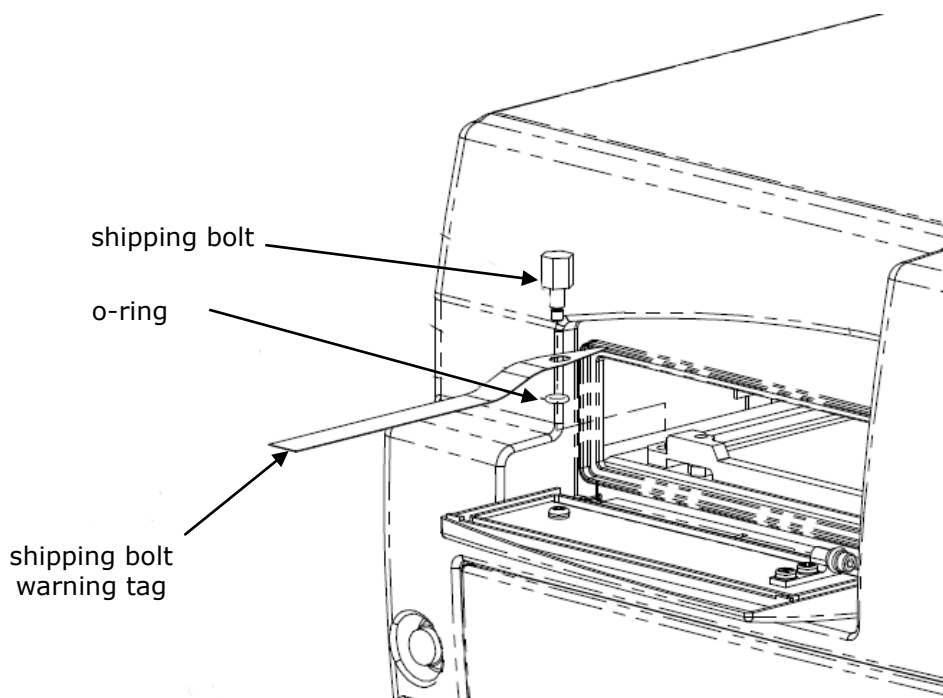

Figure 3: Removing the microplate carrier shipping bolt



Important: Replace the microplate carrier shipping bolt before repackaging the Synergy HTX for shipment. Please contact BioTek if you have misplaced the bolt (PN 1342008) and/or its o-ring (PN 49259).

4: Install the Fluorescence Lamp Assembly

Applies only to Synergy HTX models with fluorescence capability.



Important: Do not touch the glass lenses! Fingerprints on the condenser lens or heat absorber may negatively affect performance.



Warning! The fluorescence lamp assembly is hot when the instrument is powered on. If the instrument is on, turn it off and allow the lamp to cool down before attempting to replace it.

1. Locate the lamp assembly in the accessories box. The lamp is attached to a metal bracket that also holds a condenser lens and a heat absorber. Two cables are attached to the back of the lamp.
2. Open the hinged door on the front of the reader by pressing on its lower left and right corners. The lamp compartment is on the far left.
3. Orient the lamp assembly as shown below. Slide the assembly all the way into the compartment.
4. Plug the lamp cables into the power source located to the right of the lamp. Either cable can be plugged into either socket.
5. Close the hinged door.

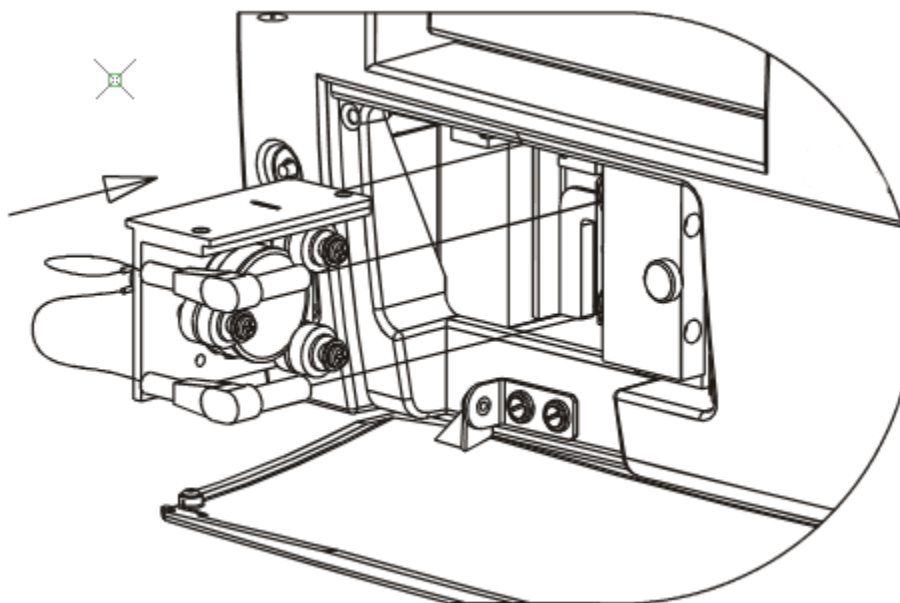

Figure 4: Installing the fluorescence lamp assembly (replacement lamp PN 7080500)

5: Select an Appropriate Location

Install the Synergy HTX on a level surface in an area where ambient temperatures between 18°C (64°F) and 40°C (104°F) can be maintained.

The reader is sensitive to extreme environmental conditions. Avoid the following:

- **Excessive humidity:** Condensation directly on the sensitive electronic circuits can cause the reader to fail internal self-checks. The specified relative humidity range for this reader is from 10% to 85% (non-condensing).
- **Excessive ambient light:** Bright sunlight or strong incandescent light may affect the reader's optics and readings, reducing its linear performance range.
- **Dust:** Readings may be affected by extraneous particles (such as dust) in the microplate wells. A clean work area is necessary to ensure accurate readings.

❖ If you will be installing BioTek's BioStack Microplate Stacker for operation with the Synergy HTX, you may wish to seat the BioStack and the reader in their aligning plates at this time. Refer to the *BioStack Operator's Manual* for more information.

6: Connect the Power Supply



Warning! Power Rating. The power supply must be connected to a power receptacle that provides voltage and current within the specified rating for the system. Use of an incompatible power receptacle may produce electrical shock and fire hazards.

Warning! Electrical Grounding. Never use a plug adapter to connect primary power to the external power supply. Use of an adapter disconnects the utility ground, creating a severe shock hazard. Always connect the power cord directly to an appropriate receptacle with a functional ground.

1. Plug the rounded end of the power supply's cord into the power inlet on the rear of the reader.
2. Connect the power cord to the external power supply.
3. Plug the power cord into an appropriate power receptacle.

7: Unpack and Inspect the Dispense Module

Applies only to Synergy HTX models with injectors.



Important! Save all packaging materials. If you need to ship the dispense module to BioTek for repair or replacement, you must use the original materials. Using other forms of commercially available packaging, or failing to follow the repackaging instructions, may **void your warranty**.

During the unpacking process, inspect the packaging, module, and accessories for shipping damage. If the reader is damaged, notify the carrier and your BioTek representative. Keep the shipping boxes and the packaging materials for the carrier's inspection. BioTek will arrange for repair or replacement of your reader immediately.

1. Open the outer shipping box. Remove the foam cap, inner shipping box, and accessories box.

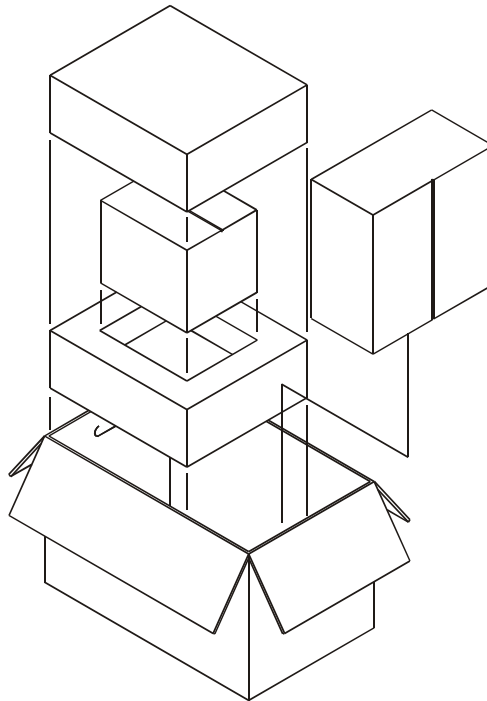

Figure 5: Unpacking the dispense module's outer shipping box

2. **Using no sharp tools**, open the box containing the dispense module. Remove the two reagent bottle holders and the cardboard shipping insert. Lift out the module and place it on a level surface.

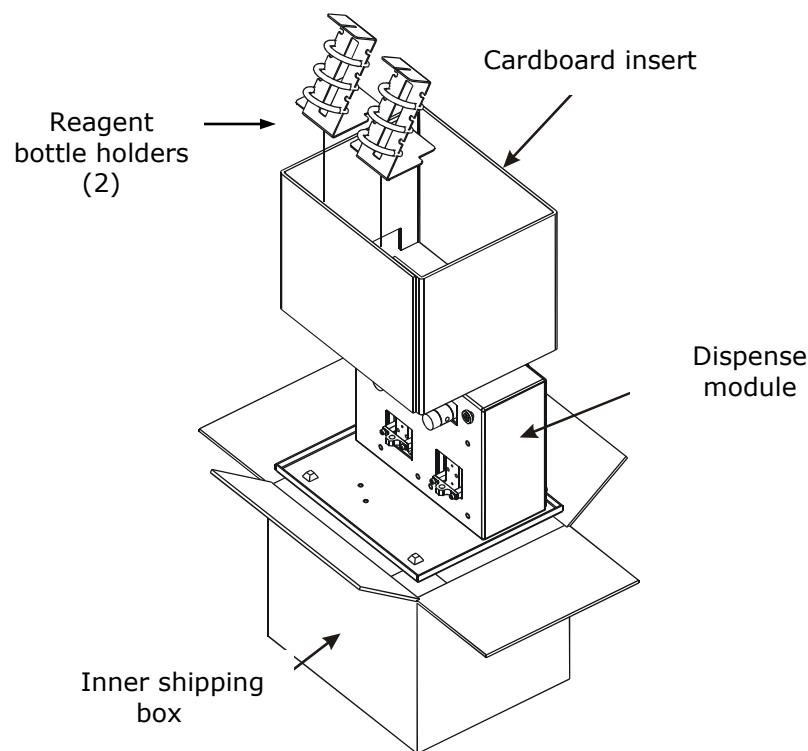

Figure 6: Unpacking the dispense module's inner shipping box

3. Open the accessories box. Remove and identify its contents (see **Figure 7** on the next page):
 - 2 inlet tubes, packaged in plastic cylinders
 - 4 outlet tubes, packaged in plastic bags
 - 2 syringes, packaged in boxes
 - 1 priming plate
 - 2 reagent bottles
 - 1 injector tip priming trough (small, plastic cup)
 - 1 plastic tool storage bag with fastener strips
 - 2 metal thumbscrews
 - 1 stylus (wire) packaged in a small plastic cylinder
 - 1 dispense module cover
 - 1 dispense module cable

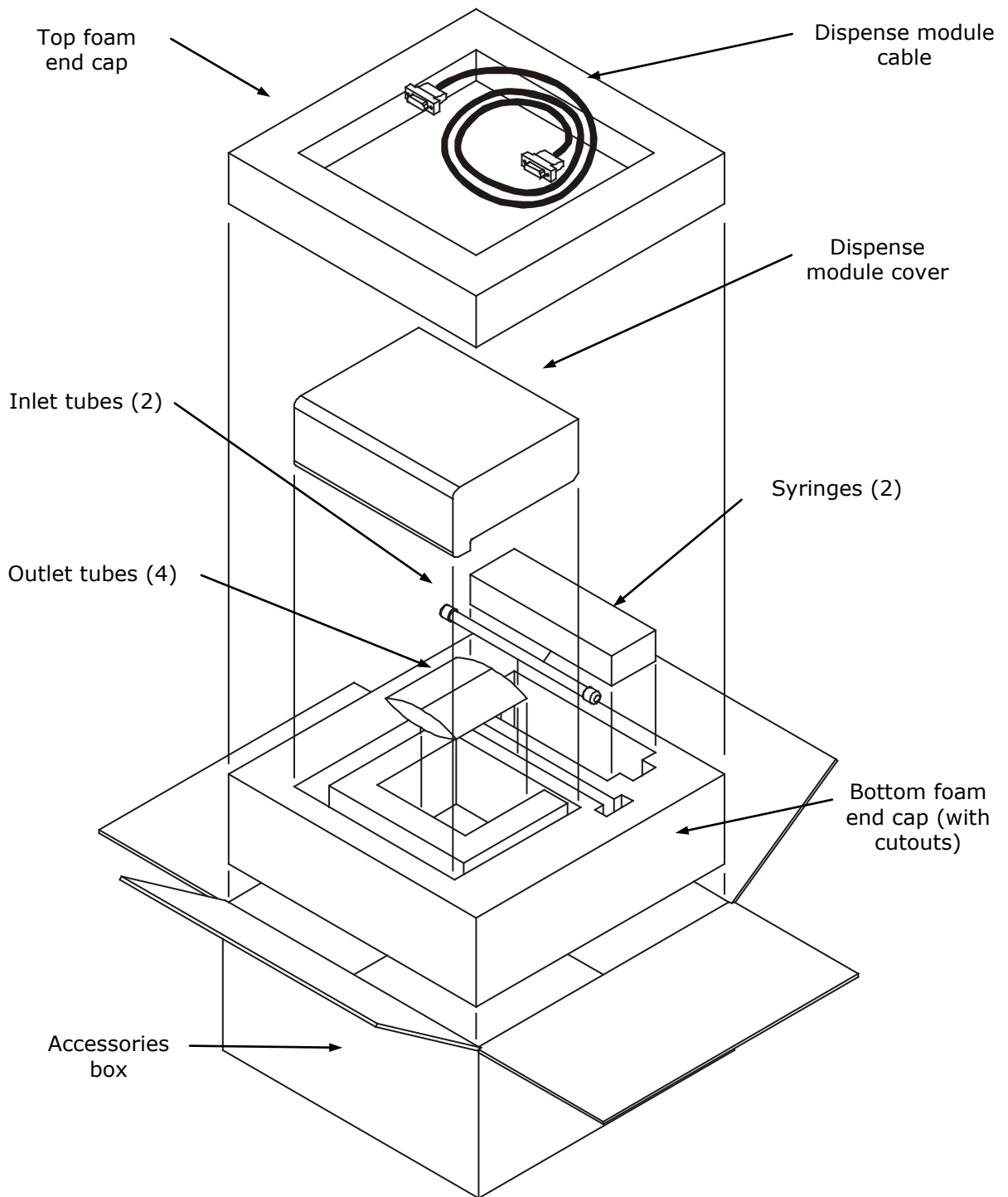

Figure 7: Unpacking the dispense module's accessories

8: Install the Dispense Module

Applies only to Synergy HTX models with injectors.

Record Syringe Calibration Values

If applicable, perform these steps to record calibration information and then install the dispenser.

1. Record the syringe calibration values that were set at BioTek:
 - a. On the back panel of the dispenser box, locate the two labels that show the six target volumes (200, 80, 40, 20, 10, and 5) and the six corresponding calibration values.
 - b. Record the 12 calibration values in the IQ Checklist.

Install the Dispenser

1. Place the module to the left side or on top of the reader.
2. On the rear panel of the reader, identify the SYRINGE 1 and SYRINGE 2 tubing ports. Remove the nylon screws from both ports and set them aside.
3. Open two of the plastic bag containing the injector tubes and tips. Remove the clear plastic shrouds from the tubes. Put the other two bags in a safe place; they are spares.
4. Remove the two inlet tubes from their plastic canisters.
5. Identify the two syringe valves on the dispense module. Each is labeled with a left-pointing arrow.

❖ When installing the inlet and outlet tubes, do not use any tools. Finger-tighten only!

6. Screw the fitting of one inlet tube into the right side of the Syringe 1 valve.
7. Screw one end of one outlet tube into the left side of the Syringe 1 valve.
8. Screw the other end of the outlet tube into the SYRINGE 1 port on the rear of the reader.
9. Repeat these steps to attach the inlet and outlet tubing for Syringe 2.

❖ It is critical that the tubing is installed in the correct ports. Otherwise, injected fluid may miss the intended well.

10. Remove the two syringes from their protective boxes. They are identical and interchangeable. Each syringe should already be assembled in one piece, but if for some reason there are two separate pieces, assemble them now: Insert the

white tip of the syringe plunger into the barrel of the syringe, and gently push it all the way into the barrel.

11. Install both syringes:
 - a. Hold the syringe vertically with the threaded end at the top.
 - b. Screw the top of the syringe into the bottom of the syringe valve. Finger-tighten only.
 - c. Carefully pull down the bottom of the syringe until it rests inside the hole in the bracket.
 - d. Pass a thumbscrew up through this hole, and thread it into the bottom of the syringe. Hold the syringe to prevent it from rotating while tightening the thumbscrew. Finger-tighten only.

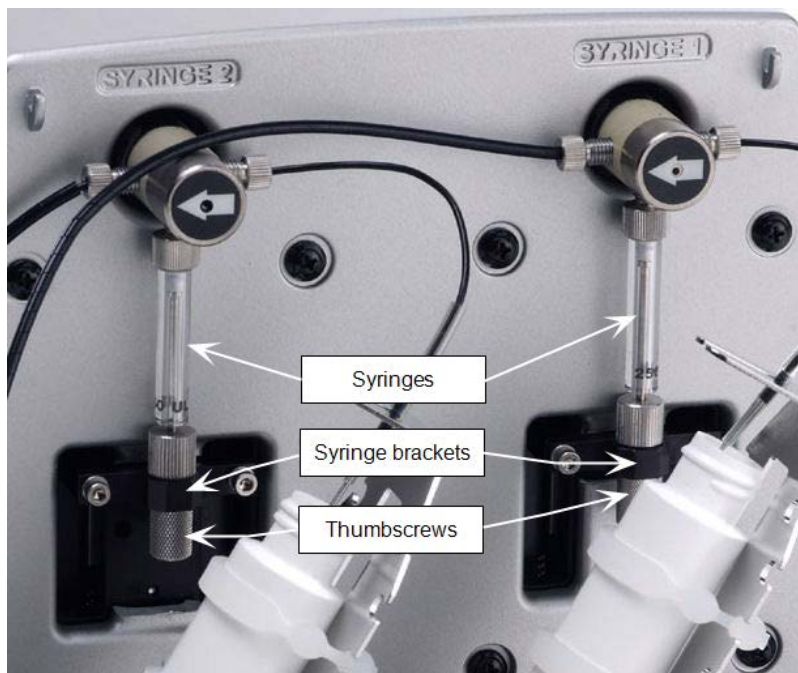

12. Locate the dispenser cable. Plug one end into the port on the left side of the dispenser. Plug the other end into the dispenser port on the rear of the reader.
13. Locate the injector-tip-cleaning stylus, packaged in a small cylinder. Attach the cylinder to the back of the dispenser for storage.

9: Connect the Host Computer

The Synergy HTX is equipped with two types of communication ports: Serial (RS-232) and USB. Both ports are located on the rear panel of the reader.

- Both types of cables are included in the accessories box. Determine which cable is supported by the host computer.
- Connect one end to the appropriate port on the reader (see photo below) and the other end to the appropriate port on the host computer.



Figure 8: RS-232 serial and USB ports on the rear panel (injector model shown)

10: Install Gen5 Software

The Synergy HTX is controlled by BioTek's Gen5 software running on a host computer. There is a certain sequence of events that *must* be followed to ensure that the software is properly installed and configured. Please follow the instructions provided in the *Gen5 Getting Started Guide* to install the software.

11: Turn on the Reader

Locate the power switch on the front panel and turn on the Synergy HTX. The reader will automatically initiate a System Test and eject the microplate carrier.



Figure 9: Carrier eject button (top) and power ON/OFF switch

12: Establish Communication

❖ **Important:** If you are using **the USB cable**, refer to the instructions that shipped with the USB Driver Software to install the necessary drivers and identify the Com Port number.

1. Start Gen5 and log in if prompted. The default System Administrator password is **admin**.
2. From the Task Manager, select **Setup > Go to System Menu**.
3. Select **System > Instrument Configuration**, and click **Add**.
4. Set the **Reader Type** to **Synergy HTX**.
5. Set the **Com Port** to the computer's COM port to which the reader is connected.
 - If using the USB cable, the information can be found via the Windows Control Panel, under Ports in the Hardware/Device Manager area of System Properties (e.g., USB Serial Port (COM5)).
6. Click the **Test Comm** button. Gen5 will attempt to communicate with the reader. If the communication attempt is successful, return to Gen5's main screen.

If the communication attempt is **not** successful, try the following:

- Is the reader connected to the power supply and turned on?
- Is the communication cable firmly attached to both the reader and the computer?
- Did you select the correct Reader Type in Gen5?
- Try a different COM port.
- If using the USB cable, did you install the driver software?

❖ If you remain unable to get Gen5 and the reader to communicate with each other, contact BioTek's Technical Assistance Center.

13: Set the Dispenser Calibration Values

Applies only to Synergy HTX models with injectors.

Before you use the dispenser with the Synergy HTX, you must set the calibration values in Gen5.

- 1 Power on the instrument, and establish communication.
- 2 In Gen5, go to **System > Instrument Configuration**, select the **Synergy HTX**, and click **View/Modify**.
- 3 Click **Setup**, and then select the **Dispenser 1 tab**.
- 4 On the keyboard, press CTRL+SHIFT+M to enter maintenance mode for the Dispenser 1 window.
- 5 Enter the syringe calibration values from the label on the rear of the dispenser box.
- 6 Click **Send Volumes**, and then click **Get Volumes** to verify that the entered values were sent to the instrument.
- 7 Select the **Dispenser 2 tab**, and repeat steps 4 through 6 for Dispenser 2.

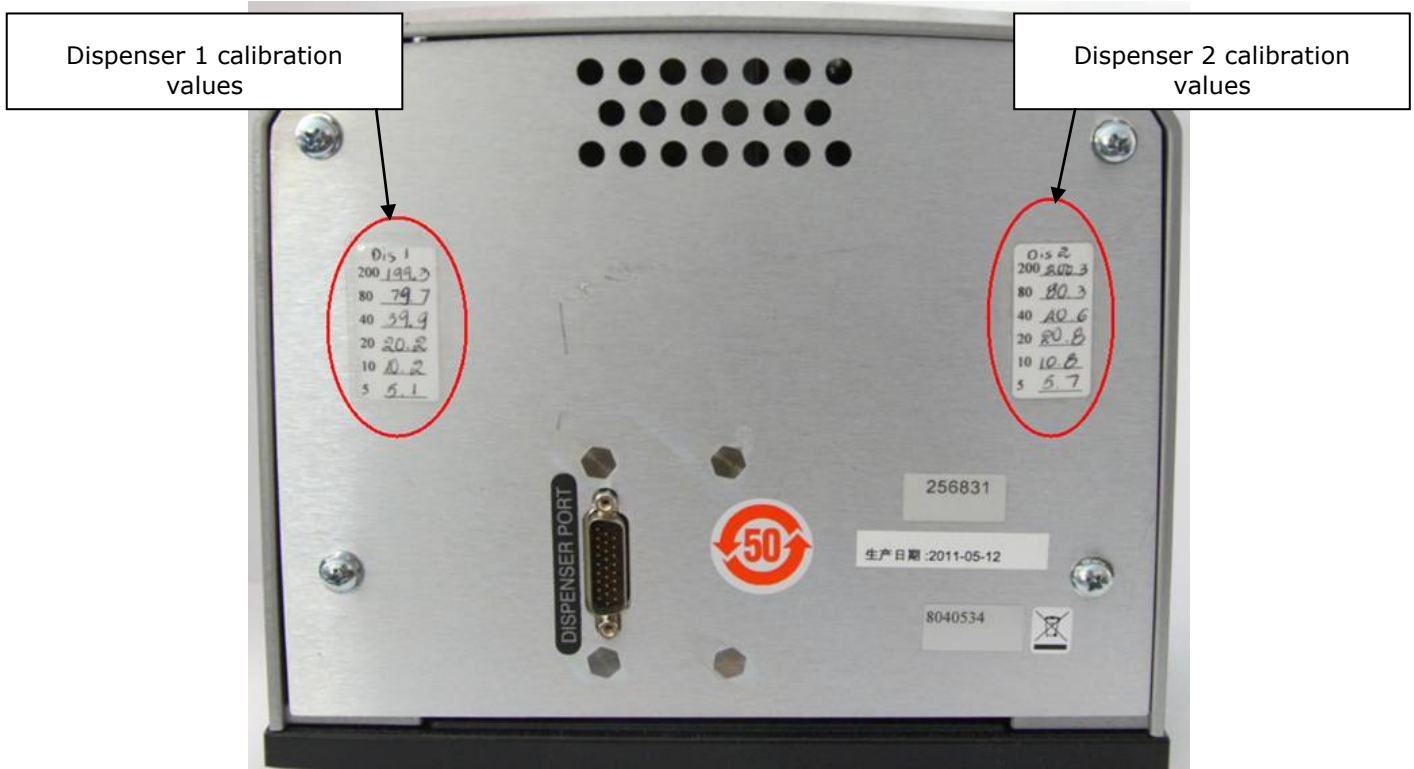

Please contact BioTek's Technical Assistance Center with any questions, tac@biotek.com.

14: Run a System Test

Running a System Test will confirm that the reader is set up and running properly, or will provide an error code if a problem has been detected.

1. Select **System > Diagnostics > Run System Test**. If prompted to select a reader, select the **Synergy HTX** and click **OK**.
2. When the test is complete, a dialog will appear requesting additional information. Enter the information (if required) and click **OK**.
3. The results report will appear, with text that reads "SYSTEM TEST PASS."
 - You may wish to print the report and store it with your Installation records.
 - The software stores system test information in its database; you can retrieve it at any time.

❖ If an error code is returned, turn to **Appendix C, Error Codes** and look up the code. If the problem is something you can fix, do so now and run another System Test. If the problem is something you cannot fix, or if the test continues to fail, contact BioTek's Technical Assistance Center.

4. **Models with injectors:** Keep the software open and proceed to **15: Test Injector System.**

All other models: The installation and setup process is complete! Close the software and turn to page 26 to read about **Operational/Performance Qualification.**

15: Test the Injector System

Applies only to Synergy HTX models with injectors.

1. If necessary, press the button above the power switch to eject the microplate carrier.
2. Place the tip priming trough in the left-rear pocket of the carrier.
3. Place the priming plate on the carrier.

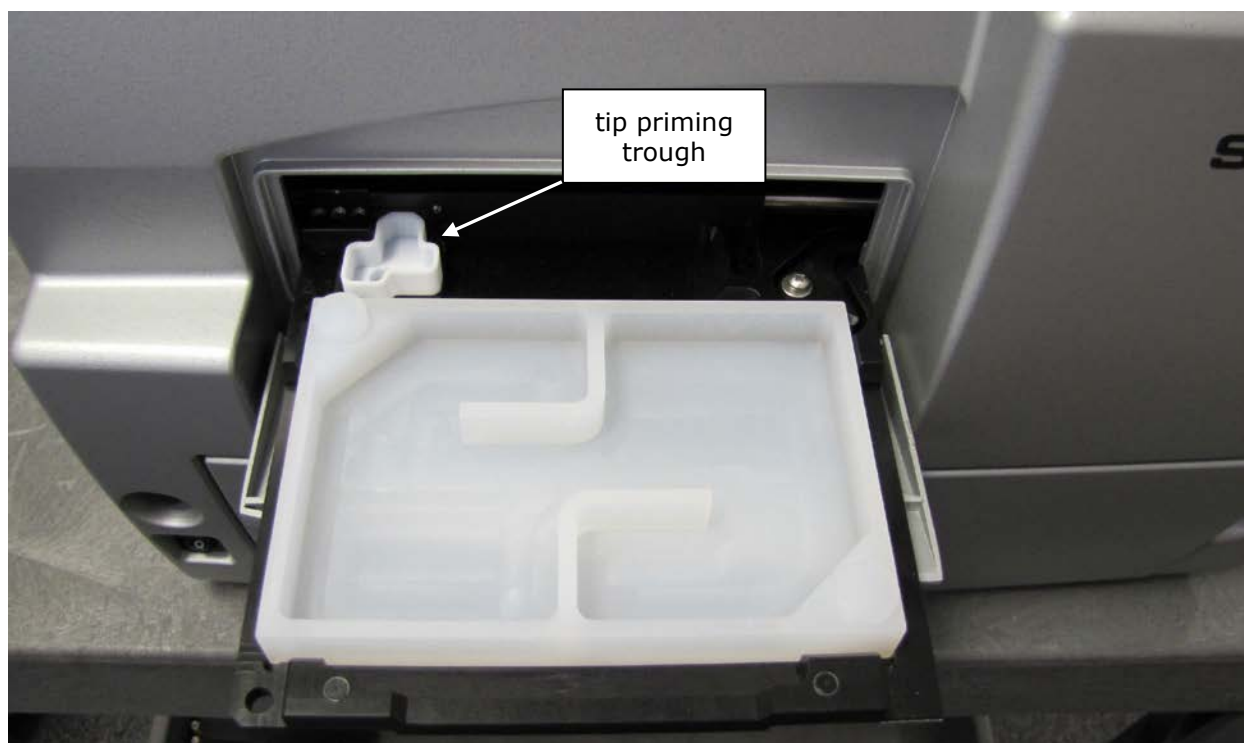

Figure 10: Installing the tip priming trough and priming plate on the microplate carrier

4. Fill the two reagent bottles with distilled or deionized water. Place the bottles in their holders, and place the holders directly in front of the syringes. Insert the inlet tubes into the bottles.

- ❖ The dispense module's setup should resemble the photo in **Figure 11**. Make any final adjustments, if necessary.

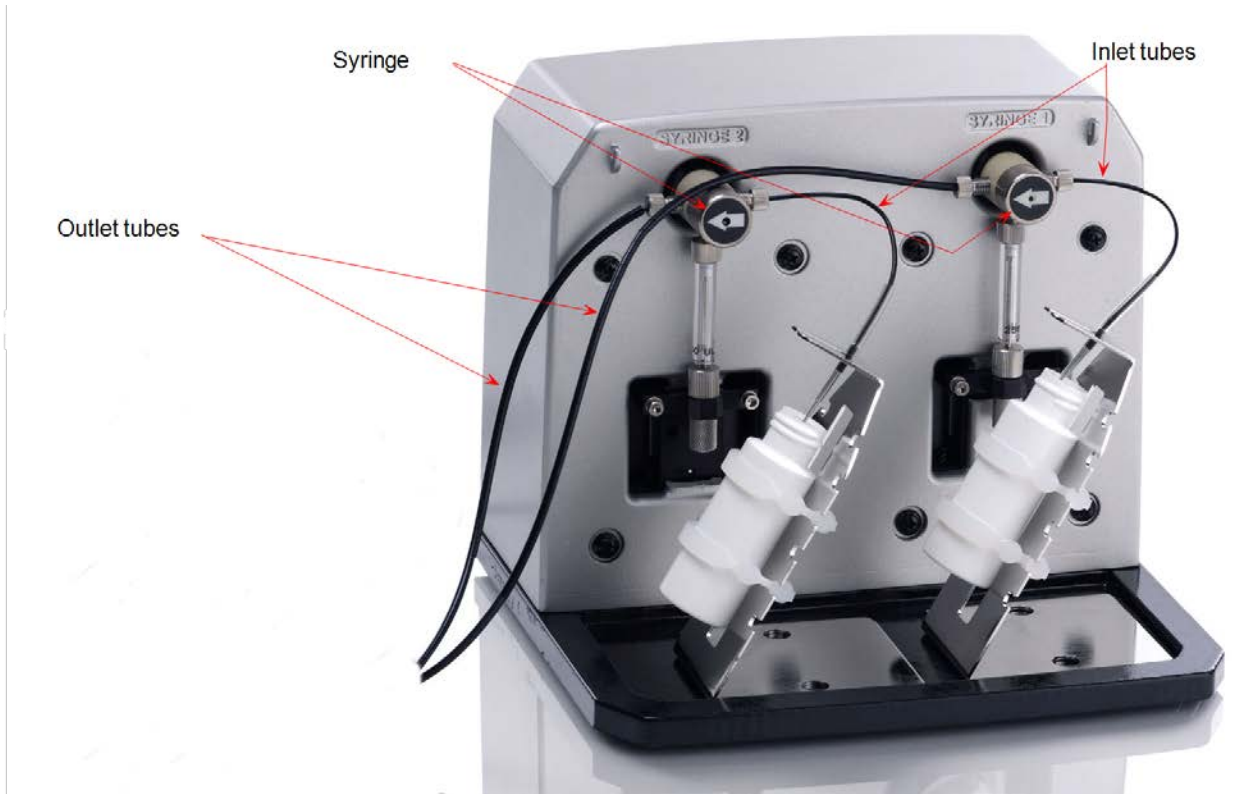

Figure 11: The fully assembled dispense module

5. Select **System > Instrument Control > Synergy HTX**.
6. Click the **Prime** tab.
7. With **Dispenser** set to **1**, set the **Volume** to **5000 μ L** and click **Prime**.
The syringe should move down and up repeatedly, drawing fluid from the bottle. The fluid should pump through the tubing and dispense into the priming plate. Examine the fittings; no leaks should be detected.
If leaks are detected, tighten all fittings and repeat the prime. If leaks are still detected, contact BioTek's Technical Assistance Center.
8. When the prime finishes, set **Volume** to **2000 μ L** and click **Purge** to clear the fluid lines.
9. Set **Dispenser** to **2** and repeat steps 7 and 8.
10. When finished, remove and empty the priming plate.
11. Close the software.

Operational/Performance Qualification

Your Synergy HTX Multi-Detection Microplate Reader was fully tested at BioTek prior to shipment and should operate properly following the successful completion of the installation and setup procedures described throughout this chapter.

If you suspect that problems occurred during shipment, if you received the reader back from BioTek following service or repair, and/or if regulatory requirements dictate that Operational/Performance Qualification is necessary, turn to **Chapter 4, Instrument Qualification** now to learn about BioTek's recommended OQ/PQ procedures for the Synergy HTX.

- ❖ An Installation-Operational-Performance Qualification (IQ/OQ/PQ) package for the Synergy HTX is available for purchase (PN 1340508). Contact your local BioTek dealer for more information.

Repackaging and Shipping Instructions



Warning! If the reader and/or dispense module has been exposed to potentially hazardous material, decontaminate it to minimize the risk to all who come in contact with the reader during shipping, handling and servicing. Decontamination prior to shipping is required by the U.S. Department of Transportation regulations. See **Appendix A** for decontamination instructions.

Caution! Remove the microplate and tip prime trough (if equipped) from the carrier before shipment. Spilled fluids can contaminate the optics and damage the instrument.



Important!

The instrument's packaging design is subject to change. If the instructions in this section do not appear to apply to the packaging materials you are using, please contact BioTek's Technical Assistance Center for guidance.

Replace the microplate carrier shipping screw and the shipping panel before repackaging the reader for shipment. Please contact BioTek if you have misplaced either of these items.

If you need to ship the Synergy HTX and/or the dispense module to BioTek for service or repair, be sure to use the original packaging materials. Other forms of commercially available packaging are not recommended and can **void the warranty**.

The shipping materials are designed to be used no more than five times. If the original materials have been damaged, lost, or used more than five times, contact BioTek to order replacements (PN 7093001 for the reader, PN 7083001 for the dispense module). See page 6 for contact information.

Perform these steps to prepare the reader for shipment:

1. Contact BioTek's Technical Assistance Center for a service authorization number before returning equipment for service. See page 6 for contact information.
2. Decontaminate the reader and, if attached, the dispense module, according to the instructions provided in **Chapter 5**.
3. If you will also be shipping the dispense module, perform these steps now:
 - a. With the reader on, start Gen5 and select **System > Instrument Control > Synergy HTX**.
 - b. Click the **Prime** tab. Ensure that "Dispenser" is set to 1.
 - c. Click the **Maintenance** button.
 - d. The Syringe 1 bracket will lower. Remove the thumbscrew from underneath the bracket. Carefully unscrew the top of the syringe from the syringe valve. Lift out the syringe and store it in its original box.
 - e. Set the Dispenser number to 2. Repeat steps **c** and **d** for Syringe 2.
 - f. Fully detach the dispense module from the reader. Replace the two nylon screws into the Syringe 1 and 2 tubing ports on the rear of the reader. (The screws should be stored in the plastic bag attached to the back of the module.) Set the module aside for the moment.

4. If you have not already done so, retract the microplate carrier and then turn off and unplug the reader.
5. Remove the lamp assembly and pack it in bubble wrap (see p. 12).
6. Replace the microplate carrier shipping screw (see p. 11).
7. Tip the reader onto its back feet. Attach the shipping panel to the bottom of the reader using the four screws and washers (see p. 10).
8. Wrap the plastic bag around the reader and shipping panel.
9. Locate the original outer shipping box. Place four foam blocks in the four bottom corners of the box. Place the inner shipping box inside the outer box (see p. 8 and 9).
10. Grasp the handles on the shipping panel and carefully lower the reader into the inner shipping box.
11. Slide the foam vertical supports into place around the reader. Place the accessories box on top.
12. Close and seal the inner box with tape.
13. Place four foam corner blocks around the inner shipping box. Close and seal the outer box with tape.
14. Write the service authorization number in large, clear numbers on the outside of the box. Ship the box to BioTek.

Perform these steps to prepare the **dispense module** for shipment:

1. If you have not already done so:
 - Contact BioTek's Technical Assistance Center for a service authorization number and shipping address before returning equipment for service. See page 6 for contact information.
 - Decontaminate the module according to the instructions in **Chapter 5**.
 - Remove the two syringes (see step 3 on the previous page) and store them in their original boxes.
 - Detach the dispense module outlet tubes and communication cable from the reader. Replace the two nylon screws into the Syringe 1 and 2 tubing ports on the rear of the reader.

❖ Refer to the illustrations in **7: Unpack and Inspect the Dispense Module** starting on page 15 when performing these steps.

2. Remove the two inlet tubes from the syringe valves and store them in their plastic canisters.
3. Remove the two outlet tubes from the syringe valves. Attach the clear plastic fitting covers to the fittings of the outlet tubes. Place the tubes in a plastic bag.

4. Place the dispense module inside the inner shipping box. Slide the cardboard shipping insert down around the module. Pack the reagent bottle holders in bubble wrap and place them on top of the module. Seal the box with tape.
5. Locate the original accessories shipping box and foam end caps. Place the bottom foam end cap into the box.
6. Place the syringes, the inlet tubes, and the outlet tubes inside the cutouts of the bottom foam end cap in the accessories box. Place the dispense module cover on top of the accessories.
7. Cover the accessories with the top foam end cap, place the dispense module cable inside the top of the end cap, and seal the box with tape.
8. Locate the original outer shipping box and foam end caps. Insert the bottom foam end cap. Lower the dispense module box into the end cap.
9. Insert the accessories box alongside the dispense module box.
10. Insert the top foam end cap. Close and seal the outer box with tape.
11. Write the service authorization number in large, clear numbers on the outside of the box. Ship the box to BioTek.

Chapter 3

Getting Started

This chapter describes some of the Synergy HTX's key components and provides an introduction to using Gen5 to control the instrument.

Key Components	32
Power Switch, Carrier Eject Button, Microplate Carrier.....	32
Lamp Assembly and Filter Wheel Access.....	33
Excitation and Emission Filter Wheels	34
Installing the Time-Resolved Fluorescence Cartridge	37
Configuring the System for Luminescence Measurements	38
The External Dispense Module	39
Gen5 Software	41
Viewing/Updating the Filter and Wavelengths Tables.....	42
Creating Protocols and Experiments.....	43
Controlling the Dispense Module	45
Recommendations for Optimum Performance	48
Incubation and Partial Plates	49

Key Components

Power Switch, Carrier Eject Button, Microplate Carrier

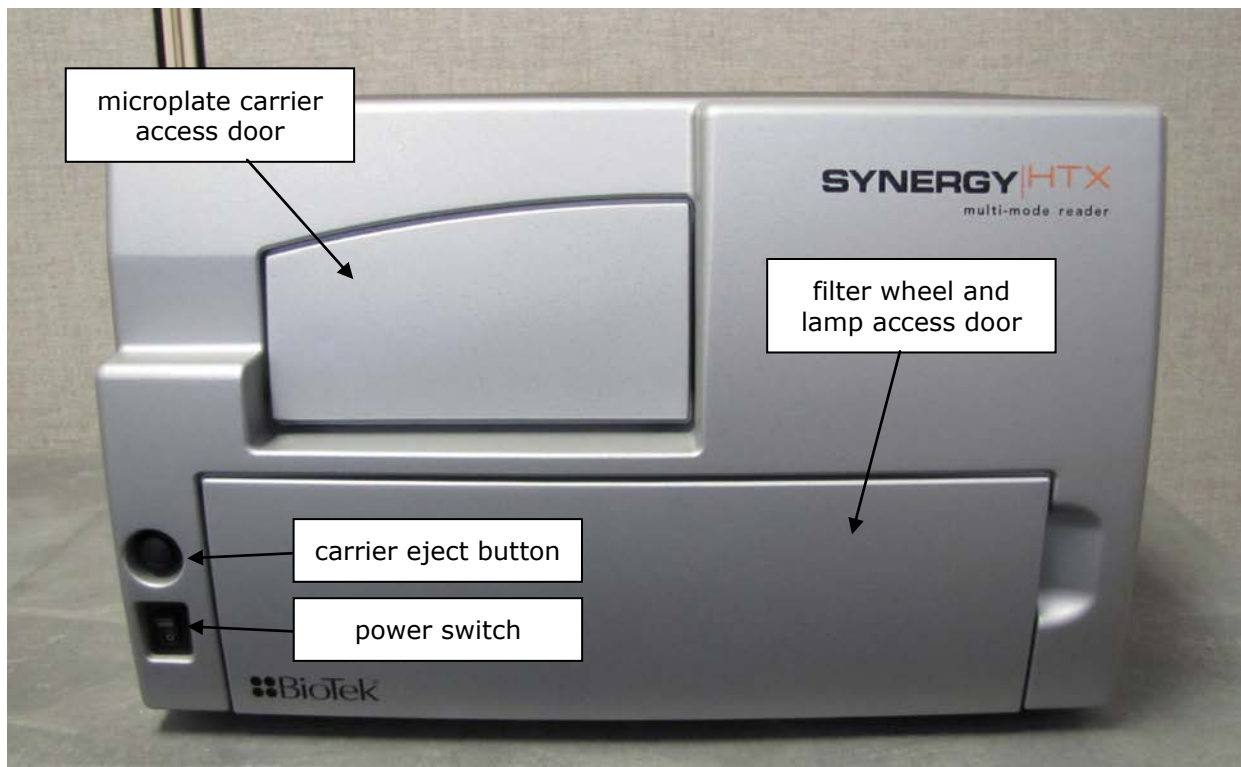

Figure 12: Power switch, carrier eject button, microplate carrier

- The power switch contains an LED, which is illuminated green when the power is on.
- The microplate carrier eject button can be used to move the microplate carrier into or out of the measurement chamber and also to stop the instrument from “beeping” when it encounters an error.
- The microplate carrier supports microplates and adapter plates as described in **Appendix A, Specifications**. The plate is positioned so that well A1 is in the left rear corner of the carrier. A spring clip holds the plate securely in place. The microplate loading door helps to ensure a light-impermeable measurement chamber. When a plate read is initiated, the carrier slides into the measurement chamber and then moves on the X and Y axes to align each microwell with the top or bottom fluorescence probe, or bottom absorbance probe, as specified in the Gen5 procedure. When the read is complete, the plate carrier slides to its full-out position.

- ❖ For fluorescence and luminescence reading modes, the height of the top optical probe can be adjusted. Use the Read Height option to define how far the top probe shall be offset from the top surface of the plate during the read. In Gen5, this option is found in a Read step within a Procedure. Refer to the Gen5 Help for further instructions.

Lamp Assembly and Filter Wheel Access

Applies only to Synergy HTX models with fluorescence and luminescence capability.

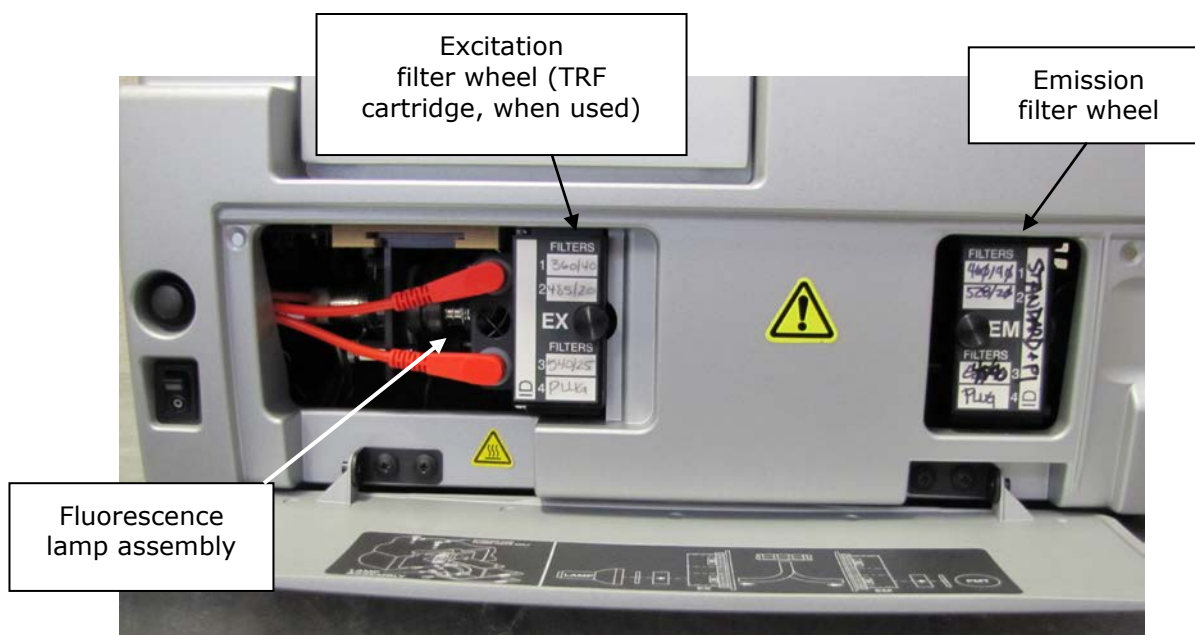

Figure 13: Accessing the fluorescence lamp assembly and filter wheels

- The fluorescence lamp assembly and the excitation and emission filter wheels are accessible via a hinged door on the front of the instrument. To open the door, slip your finger into the notch on the right side and pull the door downward. A diagram showing the location of the lamp assembly and the orientation of the excitation and emission filter wheels is printed on the inside of the hinged door.
- For models with the Time-Resolved Fluorescence feature, remove the excitation filter wheel and replace it with the “TR” cartridge before running a time-resolved fluorescence assay. See page 37 for more information on the TR cartridge.

- ❖ The Synergy HTX has two lamps: one for standard fluorescence, one for absorbance and time-resolved fluorescence:

Standard Fluorescence: The 20-watt tungsten halogen lamp's life is rated at an average of 1000 hours, and it is user-replaceable. The intensity of the bulb will slowly drop over time until the instrument's run-time self-check detects a low lamp current signal and Gen5 displays an error message. The lamp (PN 7080500) should be replaced at this time. Keeping a spare lamp on hand is recommended.

Absorbance and Time-Resolved Fluorescence: This bulb should outlive the useful life of the reader. If there is a problem with the lamp, however, the intensity may drop and the run-time self-check will detect a low signal level and generate an error message. If this happens, the instrument will require service. Contact BioTek for assistance (this lamp is not user-replaceable).

Excitation and Emission Filter Wheels

Synergy HTX models with fluorescence capability are equipped with one excitation filter wheel and one emission filter wheel; readers with luminescence capability use an emission filter wheel only. (A monochromator is used for absorbance measurements.)

A filter in the excitation wheel selects the narrow band of light to which the sample will be exposed. A filter in the emission wheel selects the band of light with the maximum fluorescence signal, to be measured by the photomultiplier (PMT).

Each filter wheel is labeled EX or EM, and can contain up to four filters and/or black "plugs." A filter can be used in either wheel, but it must be oriented properly, as described below. Each filter and plug is held securely in place with a C-clip filter retainer.

- ❖ Each filter has its wavelength and bandpass values printed on its side, with an arrow to indicate the proper direction of light through the filter.
- ❖ We recommend placing filters in the wheels in ascending wavelength order from position 1 to 4 (no holes in EX2 or EM3), particularly if the reader has generated a 4E18 (saturation) error.

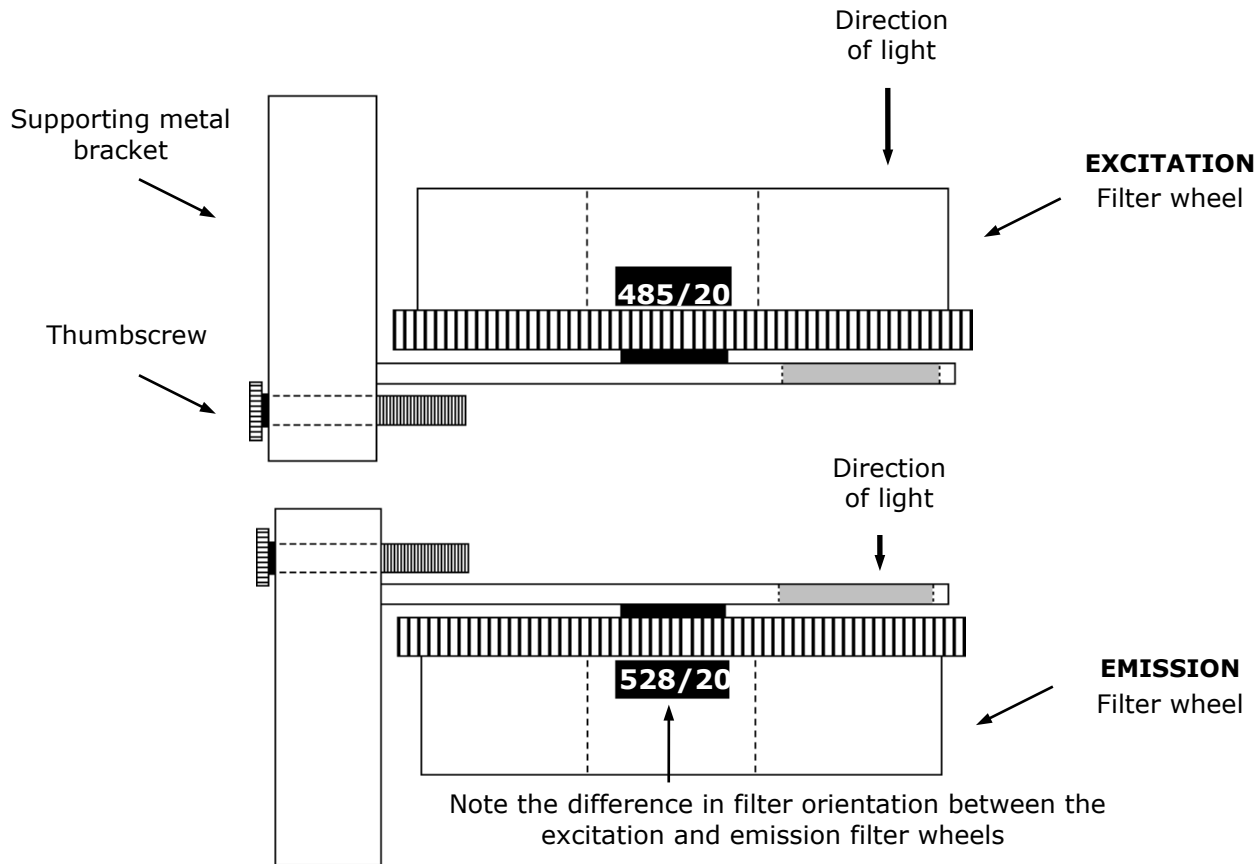

Figure 14: Profiles of the excitation and emission filter wheels, showing proper filter orientation



Important! The Synergy HTX is shipped with a set of excitation and emission filters installed, and the Synergy HTX's onboard software is preconfigured with the filter values and their locations.

If you change the contents of a filter wheel, you must update Gen5's filter table and then download the information to the reader. The Synergy HTX does not automatically detect which filters are installed.

See page 42 for information on updating Gen5's filter table.

Removing the Filter Wheels

The filter wheels can be removed if different filter wheels need to be installed. It is important to note that:

- The excitation and emission filter wheels are not interchangeable and are labeled as follows: EX = Excitation, EM = Emission. (TR = Time-Resolved Cartridge; see page 37.)
- Filter direction within a filter wheel is important, and the direction differs depending on the filter wheel. There is a diagram on the inside of the front panel door indicating this.
- Each filter is marked with an arrow indicating the proper direction of light. Refer to the figures on the previous page for proper filter orientation.

To remove a filter wheel:

1. **Important!** Turn off the instrument.
2. Open the filter wheel access door using the depression on the right side of the door.
3. Observe the two thumbscrews within the compartment. The left thumbscrew holds the excitation filter wheel in place; the right secures the emission filter wheel.
4. Remove the thumbscrew and slide the filter wheel's supporting metal bracket straight out of the compartment. **Note:** The emission filter wheel will "spring" out when removed. (This is because a shutter behind the wheel closes quickly to protect the PMT.)



Important! When removing or replacing a filter or C-clip filter retainer, do not use a sharp instrument! Use several layers of lens paper and your finger to remove and replace filters and clips. Using a sharp instrument, such as a flat screwdriver, will scratch the filter surface and make it unusable.

Do not touch the filters with your bare fingers!

To remove a filter or plug:

1. Turn the filter wheel to align the desired filter with the hole in the supporting bracket.
2. Place the bracket on a flat surface, with the filter wheel facing down.
3. Prepare a multi-layered "cushion" of lens paper. Using your finger covered with the lens paper, gently push against the filter and its C-clip retainer until they pop out.

To replace a filter or plug:

1. Hold the metal bracket with the filter wheel facing up.

2. Properly orient the filter or plug (see page 34), and then drop it into the desired filter wheel location.
3. Using your fingers, squeeze the sides of the C-clip filter retainer, and then insert it into the top of the hole containing the new filter. Cover your finger with several layers of lens paper, and then push down on all sides of the C-clip until it sits flush against the filter.
4. Clean both sides of the filter with lens paper.

To reinstall a filter wheel:

1. Ensure that all filters and/or plugs are inserted properly (see above).
2. Slide the filter wheel back into its chamber.
3. Replace the thumbscrew.
4. Close the front door.
5. Turn on the instrument.

Installing the Time-Resolved Fluorescence Cartridge

For Synergy HTX models that support time-resolved fluorescence, the “TR” cartridge must be installed in place of the excitation filter wheel before a TRF assay can be run. The TR cartridge allows light from the xenon flash bulb to be input to the fluorescence optical system within the Synergy HTX. Excitation wavelengths are selected by adjusting the monochromator from 200 to 999 nm in 1-nm increments, with a fixed bandwidth of 10 nm.

❖ The Synergy HTX automatically detects the presence of the TR cartridge. At the start of a time-resolved fluorescence assay, the operator will be prompted to install the TR cartridge if it is missing.

1. **Important!** Turn off the instrument.
2. Open the filter wheel access door using the depression on the right side of the door. Observe the two thumbscrews within the compartment. The left thumbscrew holds the Excitation filter wheel in place. See the figure on page 33.
3. Remove the left thumbscrew and slide the filter wheel’s supporting metal bracket straight out of the compartment.
4. Slide the TR cartridge into the compartment and replace the thumbscrew. Close the front door and turn on the instrument.

❖ See page 43 for more information on creating Gen5 protocols.



Figure 15: The “TR” cartridge, for time-resolved fluorescence assays

Configuring the System for Luminescence Measurements

- For best results when taking luminescence measurements, the excitation filter wheel should have no empty locations, and it should have at least one “plug” (also referred to as a “dummy filter”) installed to prevent light from reaching the samples. Remove the excitation filter wheel (see page 35) and examine its contents; ensure that there are no empty locations and there is at least one plug installed.
- If your tests require that the light emitted from the samples remain unfiltered, the emission filter wheel should have an empty location in it. Remove the emission filter wheel and examine its contents; ensure that there is an empty location.
- If you made any changes to either filter wheel, you must update Gen5’s filter table. Select “PLUG” to indicate the presence of a plug and “HOLE” to indicate an empty location. Click **Send Values** to download the information to the reader.

The screenshot shows the "Reader Setup - Synergy (Com1)" window. It has tabs for "Absorbance", "Fluorescence / Luminescence", "Dispenser 1", "Dispenser 2", "Probe Size", and "Basecode". The "Fluorescence / Luminescence" tab is active. The window is divided into "Excitation" and "Emission" sections. Each section has a table of filter configurations. The "Excitation" section has four rows, and the "Emission" section has four rows. The "Filter" column in the "Emission" section has a "Hole" selected for the fourth row. There are "Get Values" and "Send Values" buttons on the right, and "Close" and "Help" buttons at the bottom.

Excitation			Filter	Emission		
Type	Wavelength	Bandwidth		Type	Wavelength	Bandwidth
Band Pass	360	40	1	Band Pass	460	40
Band Pass	485	20	2	Band Pass	528	20
Plug			3	Band Pass	590	30
Band Pass	530	25	4	Hole		

Updating Gen5’s filter table; for complete instructions, see page 42.

- When defining a filter set in a Read step in a Gen5 procedure, selecting “Hole” indicates the empty location in the emission filter wheel. See page 43 for information on Read steps and procedures.

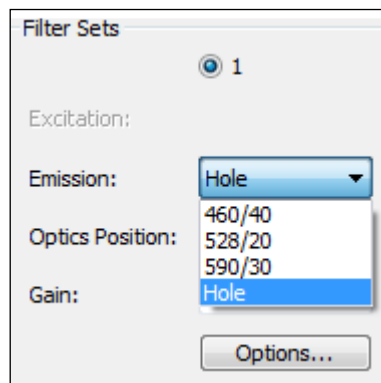

The External Dispense Module

Applies only to Synergy HTX models with injectors.

The dispense module pumps fluid from the supply bottles to injector heads located inside the instrument. Fluid is injected into one well at a time.

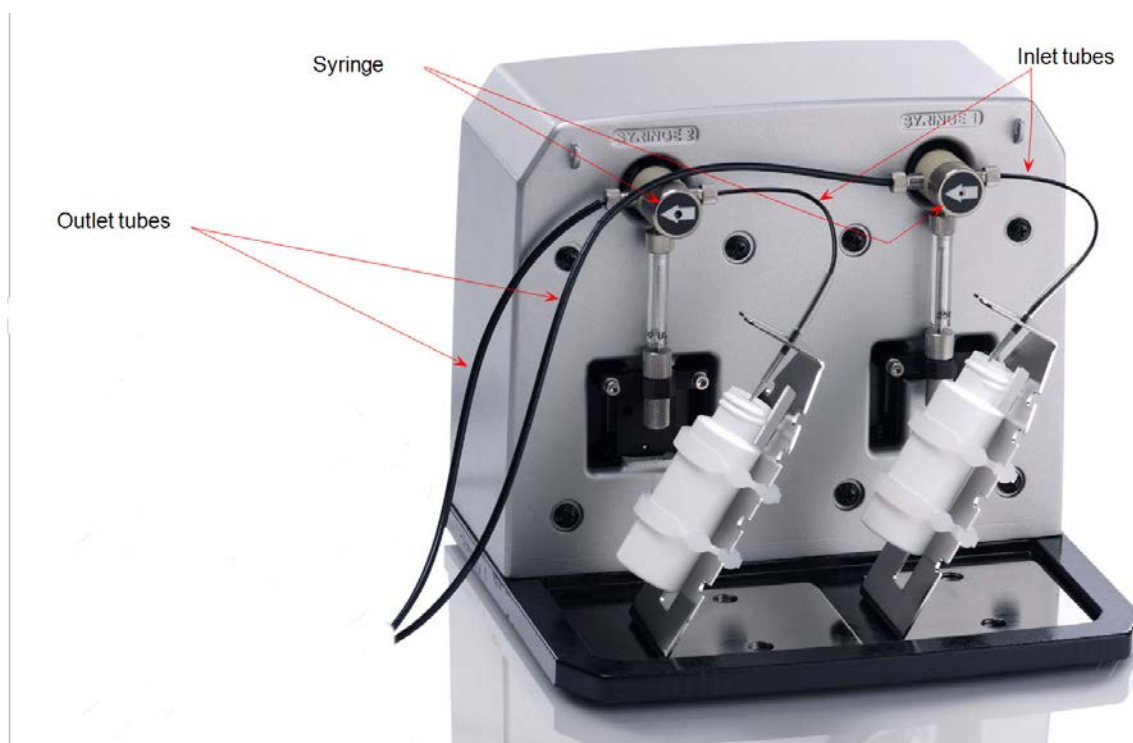

Figure 16: Dispense module components

- Two 250- μ L syringes draw fluid from the supply bottles.
- Inlet tubes transport fluid from the supply vessels to the syringes. These tubes are short pieces of opaque PTFE (Teflon) tubing connected to stainless-steel probes on one end and threaded fittings on the other end.

- Three-way valves switch the syringe flow from the inlet tubes to the outlet tubes.
- Outlet tubes transport fluid from the syringes into the instrument, through the tubing ports on the Synergy HTX's rear panel. The outlet tubes are opaque PTFE tubes with threaded fittings on each end that are used to deliver fluid from the syringes to the instrument.

Inside the Synergy HTX, two Teflon tubes transport fluid from the tubing ports on the rear of the instrument to the two injectors. As shown below, both injectors are positioned directly above the bottom fluorescence optical probe.

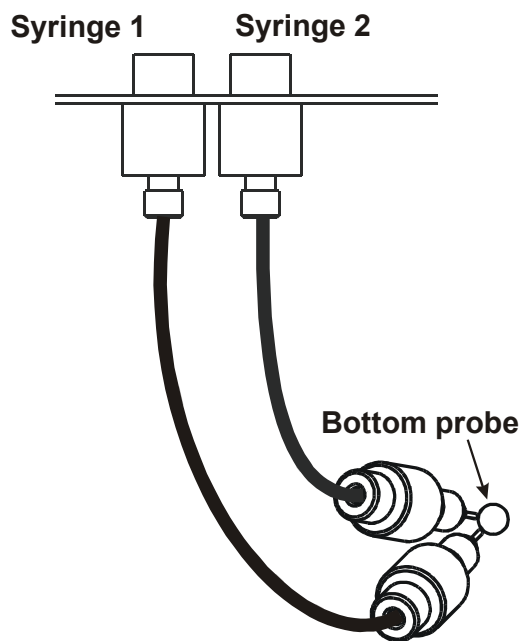

Figure 17: Close-up view of the injectors inside the instrument

❖ The tubing and injectors should be cleaned at least quarterly. See **Chapter 4, Preventive Maintenance** for more information.

Priming the System

Before an assay requiring fluid dispense is run, the system should be fully primed with the reagent or other fluid used by the assay. At the start of the assay (and optionally at the start of each dispense to a well), an additional injector tip prime can be performed. The tip prime compensates for any fluid loss at the injector tip due to evaporation since the last dispense. All priming activities are controlled via Gen5 (see page 46).

Both types of primes require a fluid reservoir to be present on the microplate carrier:

- The priming plate is about the same size as a standard microplate and is placed on the microplate carrier for a Prime operation (to prime the dispense system with fluid).
- The tip priming trough is a small, removable priming cup located in the left rear of the carrier, and is used for performing the Tip Prime before dispensing. The trough holds up to 1.5 mL of liquid and must be periodically emptied and cleaned by the user.

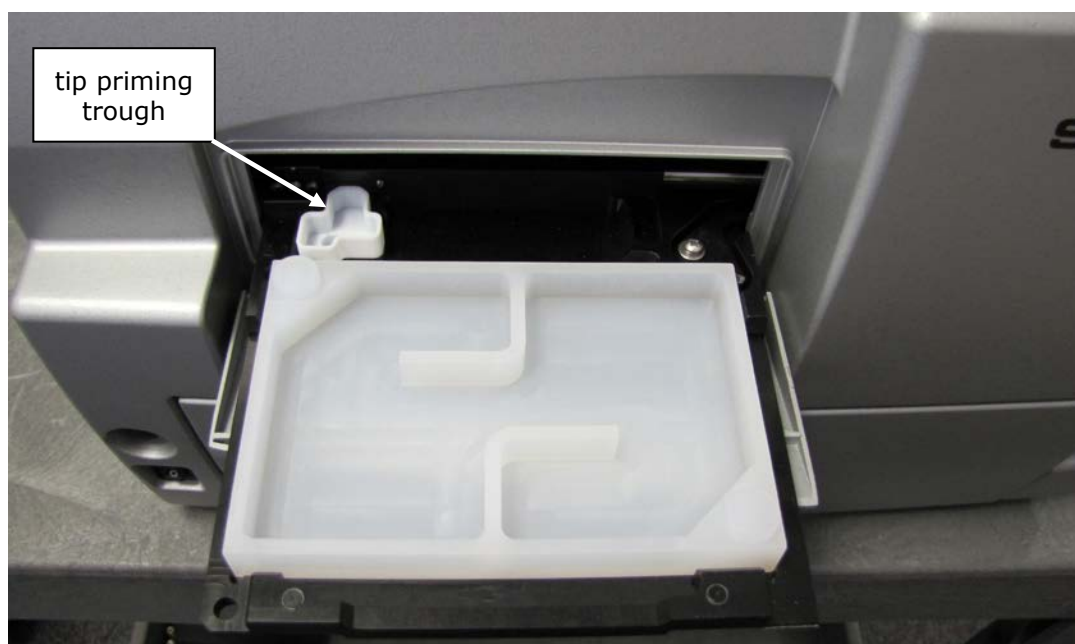

Figure 18: Priming plate and tip priming trough

Gen5 Software

BioTek's Gen5 software supports all Synergy HTX reader models. Use Gen5 to control the reader and the dispense module, perform data reduction and analysis on the measurement

values, print /export results, and more. This section provides brief instructions for creating experiments and reading plates. It also explains how to use Gen5 to perform some functions that are specific to the dispense module.

Viewing/Updating the Filter and Wavelengths Tables

If configured with fluorescence or luminescence capability, the Synergy HTX ships with a set of excitation and emission filters installed, and the reader's onboard software is preconfigured with the filter values and their locations. When Gen5 establishes communication with the reader, it "asks" for this information and then stores it in a filter table on the computer.

To view this table in Gen5, select **System > Instrument Configuration**, highlight the Synergy HTX reader, and click **View/Modify**. Click **Setup** and then click the **Fluorescence/Luminescence** tab.

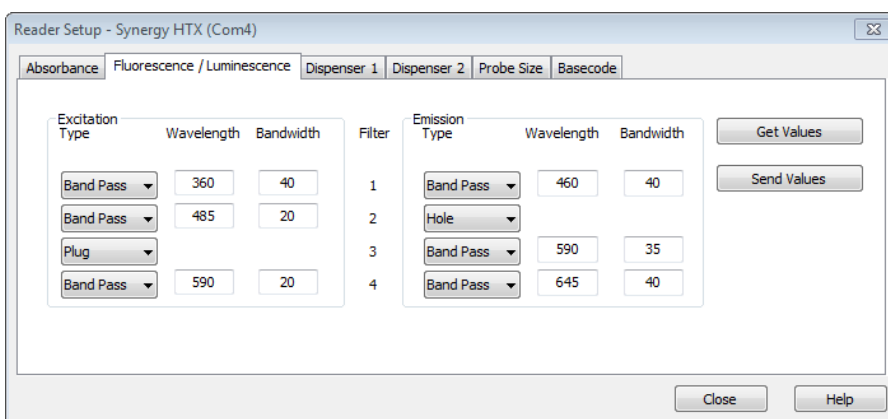

Regarding the Absorbance Wavelengths table:

The Synergy HTX performs absorbance reads in the range of 200 to 999 nm.

Click the Absorbance tab to specify and calibrate 6 wavelengths to be made available as default selections within a protocol's Reading Parameters dialog.

To change the settings and download them to the instrument:

1. Select **Band Pass**, **Plug**, or **Hole** for the excitation and emission filter wheels.
2. For each filter type, enter the wavelength value and its accompanying bandwidth. (The bandwidth is printed on the side of each filter.)
3. When finished, click **Send Values** to download the information to the reader. (Clicking **Get Values** uploads information from the reader.)
4. Click **OK** to save the settings and close this dialog. The settings become available for selection in the Read step dialog in a Procedure.

Creating Protocols and Experiments

In Gen5, a protocol contains instructions for controlling the reader and (optionally) instructions for analyzing the data retrieved from the reader. At a minimum, a protocol must specify the procedure for the assay you wish to run. After creating a protocol, create an experiment that references the protocol. You'll run the experiment to read plates and analyze the data.

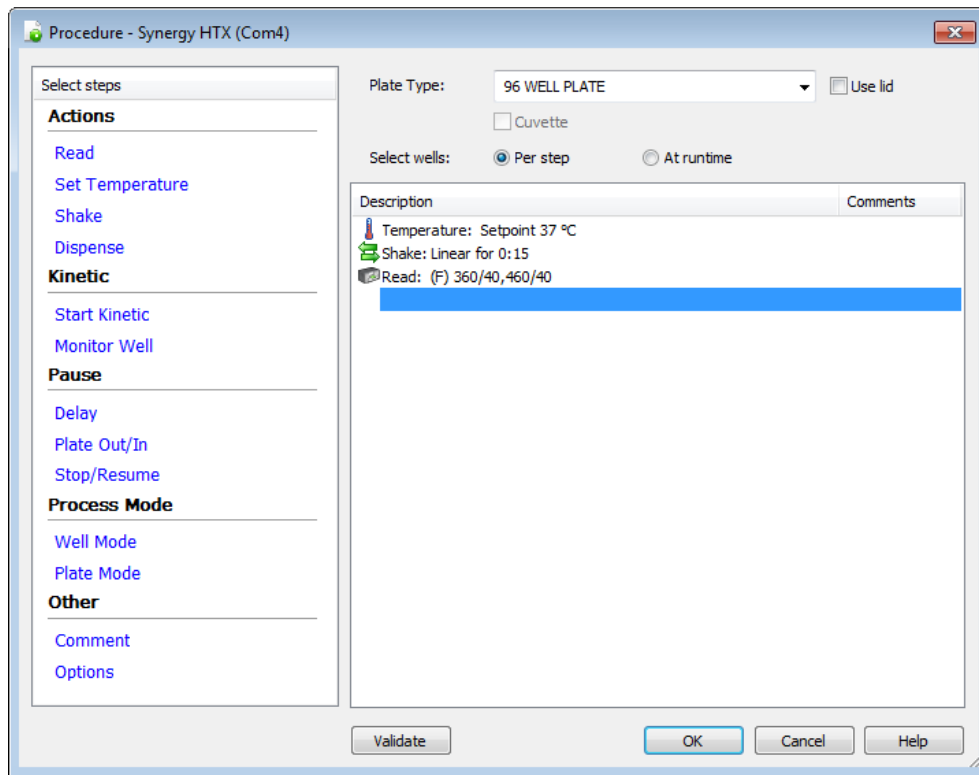

Figure 19: Defining the procedure within a Gen5 protocol

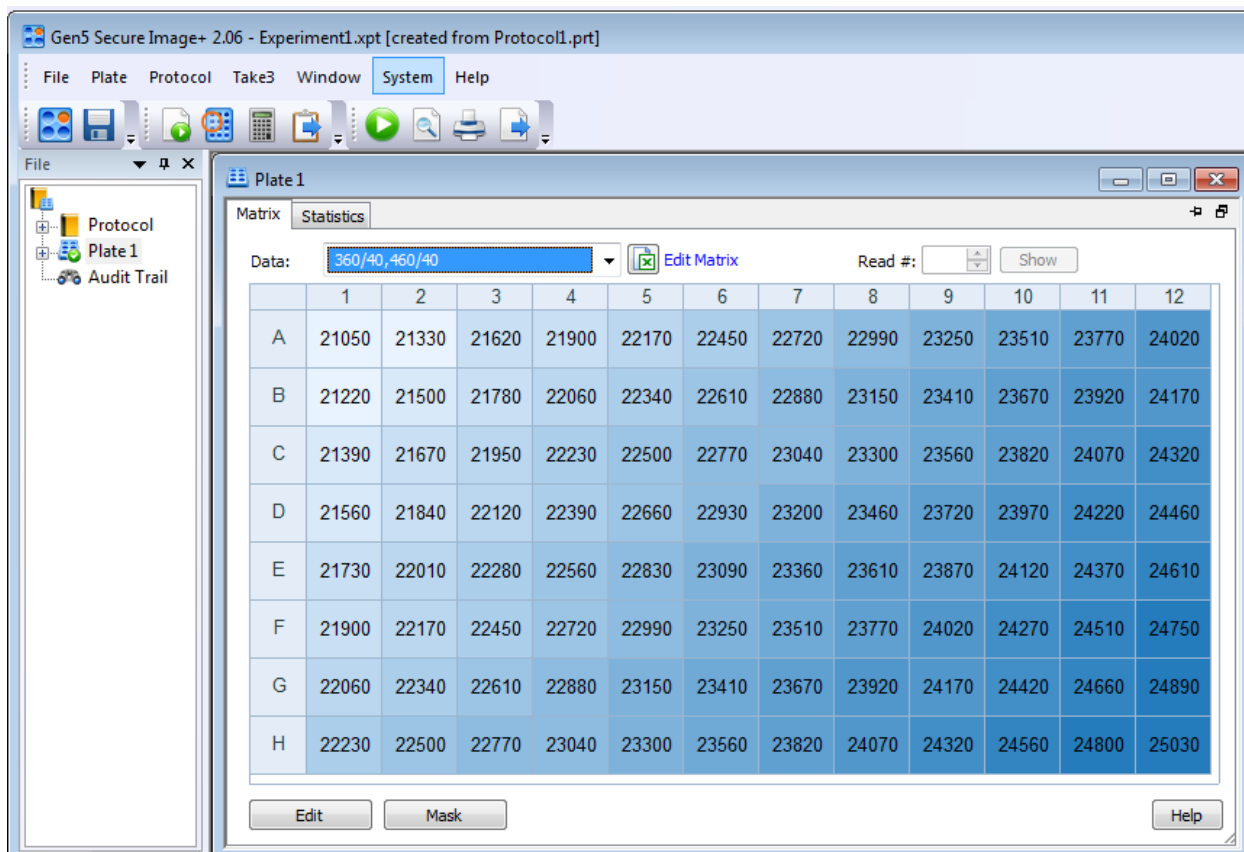

Figure 20: An experiment (containing measurement data), based on a predefined protocol

The instructions below briefly describe how to create a simple protocol in Gen5. For more information, or if the instructions below do not match what you see in Gen5, refer to the *Gen5 Getting Started Guide* or Help system.

1. To create a new protocol, from the Task Manager, select **Protocols > Create New**.
2. Select **Protocol > Procedure**. If prompted to select a reader, select the **Synergy HTX** and click **OK**.
3. Select a plate type.

❖ The assay plate must match the plate type selected in Gen5. Otherwise, the results of the read may be invalid.

4. Add steps to the procedure for shaking or heating the plate, dispensing fluid, reading the plate, and more. Click **Validate** to verify that the reader supports the defined steps, and then click **OK**.

Tips:

- Add a Dispense step to define the volume and rate at which fluid will be dispensed, and from which dispenser.

- Add a Read step to specify the detection method and filter sets or wavelength values, enable time-resolved fluorescence, and set the Top Probe Vertical Offset value.
 - To define a Kinetic read, place an Endpoint Read step inside a Kinetic Start/End loop.
5. Open the Plate Layout dialog and assign blanks, samples, controls, and/or standards to the plate.
 6. Open the Data Reduction dialog to add data reduction steps. Categories include Transformation, Well Analysis, Curve Analysis, and more.
 7. Create a report or export template, via one of the Report/Export Builder options.
 8. Save the file with an identifying name.

The instructions below briefly describe how to create an Experiment based on an existing protocol and then read a plate. See Gen5's Help system for complete instructions.

1. To create a new experiment, from the Task Manager click, **Experiments > Create using an existing protocol**.
2. Select the desired protocol and click **OK**.
3. Select **Plate > Read** or click the Read Plate icon.
4. Click **OK** when the Load Plate dialog appears. The plate will be read.
5. When the read is complete, measurement values will appear in Gen5. To view them, select the desired data set (e.g., "528/20,645/40") from the Data drop-down list.
6. If you have not already done so, save the file with an identifying name.

Controlling the Dispense Module

Applies only to Synergy HTX models with injectors.

Gen5 is used to perform several dispense module-specific functions, including initializing, priming, and purging. Gen5 also contains certain configuration items that must be set before using the dispense module. Read the following sections to become familiar with these functions and configuration items.

Initialization

If the dispense module was connected to the reader before the reader was turned on, or if a System Test was run via Gen5, the dispense module should initialize automatically. If for any reason the module does not initialize automatically, you can initialize it from Gen5:

1. In Gen5, select **System > Instrument Control > Synergy HTX** and click the **Prime** tab.

2. Select the desired Dispenser number (1 or 2) and click **Initialize**. The syringe drive will move to its home position and its sensors will be verified. Upon successful completion, the Initialized field should show “Yes”.

Prime Utility

Before running an experiment with a Dispense step, the dispense module and its associated tubing must be primed with the fluid to be used. Gen5 provides a special utility for this task. To prime the dispense module:

1. Fill the supply bottle with a sufficient volume of the fluid to be used for the prime and the assay. Insert the appropriate inlet tube into the bottle.
2. **Important!** Place the priming plate on the carrier.
3. In Gen5, select **System > Instrument Control > Synergy HTX** and click the **Prime** tab.
4. Select the Dispenser number (1 or 2) associated with the supply bottle.
5. Enter the Volume to be used for the prime, from 5 to 5000 μL . The minimum recommended prime volume is 1100 μL .
6. Select a prime Rate, in $\mu\text{L}/\text{second}$.
7. Click **Prime** to start the process.
8. When the process is complete, carefully remove the priming plate from the carrier and empty its contents. If the priming plate is empty, the prime volume was too low.

Purge Utility

Gen5 provides a special utility to purge fluid from the dispense tubing and syringe by pumping the fluid in reverse, back into the supply bottle. To purge the dispense module:

1. In Gen5, select **System > Instrument Control > Synergy HTX** and click the **Prime** tab.
2. Select the Dispenser number (1 or 2) associated with the supply bottle.
3. Enter the desired purge Volume in μL .
4. Select a prime Rate in $\mu\text{L}/\text{second}$.
5. Click **Purge** to start the process.

Syringe Maintenance Position

Gen5 provides access to special syringe setup functions for maintenance and calibration purposes. If a syringe needs to be installed or replaced, it must first be moved to its “Maintenance Position.” To do this using Gen5:

1. Select **System > Instrument Control > Synergy HTX** and click the **Prime** tab.
2. Select the appropriate Dispenser number (1 or 2) associated with the syringe.
3. Click **Maintenance**. The syringe plunger will move to its furthest-from-home position. The syringe can then be disconnected from the drive bracket and unscrewed from the valve.
4. See “Install Dispense Module Components” in **Chapter 2, Installation** for information on installing/removing the syringes.



Important! Do not change the syringe positions or calibrate the dispensers unless instructed to do so as part of installation, upgrade, or maintenance.

Recommendations for Optimum Performance

- Microplates should be perfectly clean and free from dust or bottom scratches. Use new microplates from sealed packages. Do not allow dust to settle on the surface of the solution; use microplate covers or seals when not reading the plate. Filter solutions to remove particulates that could cause erroneous readings.
- Before preparing your microplates, make sure the instrument is on and successfully communicating with the controlling software. You may want to run a System Test if the instrument has not been turned off/on in a few days. Design your Gen5 protocol in advance as well, to ensure that the intended reading parameters are used and to avoid any last-minute corrections.
- Although the Synergy HTX supports standard flat, U-bottom, and V-bottom microplates, the reader achieves optimum performance with optically clear, flat-bottomed wells. See **Appendix A, Specifications** for more information on the supported plates.
- Non-uniformity in the optical density of the well bottoms can cause loss of accuracy, especially with U- and V-bottom polyvinyl microplates. Check for this by reading an empty microplate. Dual wavelength readings can eliminate this problem, or bring the variation in density readings to within acceptable limits for most measurements.
- Inaccuracy in pipetting has a large effect on measurements, especially if smaller volumes of liquid are used. For best results, use at least 100 μL per well in a 96-well plate and 25 μL in a 384-well plate.
- Dispensing solution into 384-well plates often traps air bubbles in the wells, which may result in inaccurate readings. A dual-wavelength reading method usually eliminates these inaccuracies; however, for best results, remove the air bubbles by degassing the plate in a vacuum chamber before reading.
- The inclination of the meniscus can cause loss of accuracy in some solutions, especially with small volumes. Agitate the microplate before reading to help bring this problem within acceptable limits. Use Tween 20, if possible (or some other wetting agent) to normalize the meniscus for absorbance measurements. Some solutions develop menisci over a period of several minutes. This effect varies with the brand of microplate and the solution composition. As the center of the meniscus drops and shortens the light path, the density readings change. The meniscus shape will stabilize over time.

- To keep the dispense system in top condition, flush and purge the fluid lines with deionized (DI) water every day or upon completion of an assay run, whichever is more frequent. Some reagents may crystallize or harden after use, clogging the fluid passageways. Flushing the tubing at the end of each day, letting the DI water soak them overnight, and then purging the lines at the beginning of each day ensures optimal performance of the dispense system. See **Chapter 4, Preventive Maintenance** for more information.
- **For models with injectors:** When dispensing volumes less than or equal to 20 μL /well, we recommend specifying a tip prime volume that is equal to the dispense volume. For dispense volumes greater than 20 μL /well, we recommend a tip prime volume of 20 μL .

Incubation and Partial Plates

When performing a partial plate read that includes an incubation step, the following recommendations can reduce the effects of evaporation of your samples:

- Use microplate lids.
- Fill unused wells with fluid.
- Cluster your sample wells rather than spacing them throughout the plate.
- Place your sample wells in the center of the plate. This placement may lead to less evaporation than if you place the samples in wells on the edge of the plate.

Chapter 4

Preventive Maintenance

This chapter provides step-by-step instructions for maintaining the Synergy HTX and external dispense module (if used) in top condition, to ensure that they continue to perform to specification.

Recommended Maintenance Schedule	52
Overview	52
Daily Cleaning for the Dispense Module.....	52
Recommended Maintenance Schedule.....	53
Warnings and Precautions	54
Cleaning Exposed Surfaces	55
Inspect/Clean Excitation and Emission Filters	56
Flush/Purge the Fluid Path	57
Running a Dispense Protocol (Optional)	58
Empty/Clean the Tip Priming Trough	59
Clean the Priming Plate	59
Clean the Internal Components	60
Required Materials	61
Removing the Reader's Shroud	62
Removing the Internal Tubes and Injector Heads	64
Cleaning the Internal Tubes and Injector Heads	67
Cleaning the Optical Probes.....	68
Cleaning the Reader's Internal Surface	76
Reassembling the Components	77
Performance Check	79

Recommended Maintenance Schedule

Overview

A general **Preventive Maintenance (PM)** regimen for all Synergy HTX models includes periodically cleaning all exposed surfaces and inspecting/cleaning the Excitation and Emission filters. For models with the external dispense module, additional tasks include flushing/purging the fluid path and cleaning the tip prime trough, priming plate, supply bottles, internal dispense tubing, and injector heads.

Daily Cleaning for the Dispense Module

To keep the dispense module and injectors in top condition, flush and purge the fluid lines with deionized (DI) water every day or upon completion of an assay run, whichever is more frequent. Some reagents may crystallize or harden after use, clogging the fluid passageways. Flushing the tubing at the end of each day, letting the DI water soak them overnight, and then purging the lines at the beginning of each day ensures optimal performance of the dispense system. Perform a visual inspection of the dispensing accuracy before conducting an assay that requires a dispense step to verify instrument performance.

It is important to keep the dispensing lines scrupulously clean at all times. Take special care when using molecules active at very low concentrations (e.g., enzymes, inhibitors). Remove any residual reagent in the dispensing lines using a suitable cleaning solution (review the reagent's package insert for specific recommendations).

A daily cleaning regimen is the best way to ensure accurate performance and a long life for your instrument and dispense module. BioTek also recommends flushing the module with DI water before conducting the decontamination procedure described in **Chapter 5, As-Needed Maintenance**.

Recommended Maintenance Schedule

The following charts recommend Preventive Maintenance tasks and the frequency with which each task should be performed.

❖ It is important to note that the risk and performance factors associated with your assays may require that some or all of the procedures be performed more frequently than presented in the schedule.

Task	Page	Daily	Quarterly	As Needed
All models:				
Clean exposed surfaces	55			✓
Inspect/clean excitation and emission filters (if equipped)	56		✓	
Decontamination	<i>see Chapter 5</i>	<i>before shipment or storage</i>		
Models with injectors only:				
Flush/purge the fluid path	57	✓		
(Optional) Run Dispense protocol	58			✓
Empty/clean tip prime trough	59	✓		
Clean priming plate	59			✓
Clean internal components tubing and injector heads	67		✓	
Clean optical probes	68		✓	
Clean internal surfaces	76		✓	

Warnings and Precautions

	Warning! Internal Voltage. Turn off and unplug the instrument for all maintenance and repair operations.
	Warning! Wear protective gloves when handling contaminated instruments. Gloved hands should be considered contaminated at all times; keep gloved hands away from eyes, mouth, nose, and ears.
	Warning! Mucous membranes are considered prime entry routes for infectious agents. Wear eye protection and a surgical mask when there is a possibility of aerosol contamination. Intact skin is generally considered an effective barrier against infectious organisms; however, small abrasions and cuts may not always be visible. Wear protective gloves when handling contaminated instruments.
	Important! Do not immerse the instrument, spray it with liquid, or use a “wet” cloth on it. Do not allow water or other cleaning solution to run into the interior of the instrument. If this happens, contact BioTek’s Technical Assistance Center.
	Important! Do not apply lubricants to the microplate carrier or carrier track. Lubrication on the carrier mechanism or components in the carrier compartment will attract dust and other particles, which may obstruct the carrier path and cause the reader to produce an error.
	Caution! The buildup of deposits left by the evaporation of spilled fluids within the read chamber can impact measurements. Be sure to keep System Test records before and after maintenance so that changes can be noted.
	Caution! Models with injectors. Before removing the reader’s cover to expose internal parts, purge the dispense module, turn off the instrument, and disconnect the fluid line, power cable, and PC cable.
	Warning! The fluorescence lamp assembly is hot when the instrument is powered on. If the instrument is on, turn it off and allow the lamp to cool down before attempting to replace it.

Cleaning Exposed Surfaces



Important! Turn off and unplug the instrument for all cleaning operations.

Important! Do not immerse the instrument, spray it with liquid, or use a “wet” cloth. Do not allow the cleaning solution to run into the interior of the instrument. If this happens, contact BioTek’s Service Department.

Exposed surfaces may be cleaned (not decontaminated) with a cloth moistened (not soaked) with water or water and a mild detergent. You will need:

- Deionized or distilled water
- Clean, lint-free cotton cloths
- Mild detergent (optional)

To clean the exposed surfaces:

1. Turn off and unplug the instrument.
2. Moisten a clean cotton cloth with water, or with water and mild detergent.
Do not soak the cloth.
3. Wipe the plate carrier and all exposed surfaces of the instrument.
4. Wipe all exposed surfaces of the dispense module (if used).
5. If detergent was used, wipe all surfaces with a cloth moistened with water.
6. Use a clean, dry cloth to dry all wet surfaces.
7. Reassemble the instrument as necessary.

- ❖ **Models with injectors:** If the Tip Priming Trough overflows, wipe the carrier and the surface beneath the carrier with a dry cotton cloth. If overflow is significant, you may have to remove the shroud of the instrument to better access the surface beneath the carrier.
- ❖ See page 62 for instructions on removing the shroud.
- ❖ See page 76 for instructions for cleaning the surface beneath the carrier.

Inspect/Clean Excitation and Emission Filters

Applies only to Synergy HTX models with fluorescence and luminescence capability.

Laboratory air is used to cool the lamp, and the filters can become dusty as a result. The filters should be inspected and cleaned at least every three months. You will need:

- Isopropyl, ethyl, or methyl alcohol
- Lens-cleaning tissue

❖ **Do not touch the filters with your bare fingers!**

To inspect and clean the excitation and emission filters:

1. Turn off and unplug the instrument.
2. Pull down the hinged door on the front of the instrument. Observe the two thumbscrews within the compartment. The left thumbscrew holds the excitation (EX) filter wheel in place; the right secures the emission (EM) filter wheel. Remove each thumbscrew and slide the filter wheel's supporting metal bracket straight out of the compartment.

❖ **Chapter 3, Getting Started** contains illustrations for identifying the filter wheels and their unique characteristics. This chapter also contains instructions for replacing filters if necessary.

3. Inspect the glass filters for speckled surfaces or a halo effect. This may indicate deterioration due to moisture exposure over a long period of time.
 - If you have any concerns about the quality of the filters, contact your BioTek representative.
4. Clean the filters using lens-cleaning tissue moistened with a small amount of isopropyl, ethyl, or methyl alcohol. Ensure that the filters remain in their current locations.
5. Replace the filter wheel brackets in their respective positions and replace the thumbscrews. Close the hinged door.

Flush/Purge the Fluid Path

Applies only to Synergy HTX models with injectors.

At the end of each day that the dispense module is in use, flush the fluid path using Gen5's priming utility. Leave the fluid to soak overnight or over a weekend, and then purge the fluid before using the instrument again.

❖ This flushing and purging routine is also recommended before disconnecting the outlet tubes from the rear of the reader, and before decontamination to remove any assay residue prior to applying isopropyl alcohol or sodium hypochlorite.

To flush the fluid path:

1. Fill two supply bottles with deionized or distilled water. Insert the supply (inlet) tubes into the bottles.
2. Place the priming plate on the carrier.
3. From Gen5's main screen, select **System > Instrument Control**. Select the appropriate reader if prompted.
4. Click the **Prime** tab and select **Dispenser 1**.
5. Set the **Volume** to 5000 μL . Keep the default prime **Rate**.
6. Click **Prime** to start the process. When the process is complete, carefully remove the priming plate from the carrier and empty it.
7. Repeat the process for **Dispenser 2**.

Leave the water in the system overnight or until the instrument will be used again. Purge the fluid from the system (see below) and then prime with the dispense reagent before running an assay.

To purge the fluid from the system:

1. Place the inlet tubes in empty supply bottles or a beaker.
2. Select **System > Instrument Control**. Select the appropriate reader if prompted.
3. Click the **Prime** tab and select **Dispenser 1**.
4. Set the **Volume** to 2000 μL .
5. Click **Purge** to start the process.

When the purge is complete, repeat the process for **Dispenser 2**.

❖ After purging the system, you may wish to run a quick Dispense protocol to visually verify the dispense accuracy. See the next page for instructions for creating the protocol.

Running a Dispense Protocol (Optional)

Applies only to Synergy HTX models with injectors.

After flushing/purging the system (page 57) and before running an assay that requires dispense, take a moment to visually inspect the dispensing accuracy.



Use a DI H₂O-Tween solution to check for dispense accuracy following maintenance: e.g., add 1 mL Tween 20 to 1000 mL of deionized water.

❖ Select a Plate Type in the Protocol that matches the plate you are using.

1. Create a new protocol and then select **Protocol > Procedure**.
2. Add a Dispense step with the following parameters:
 - Select **Dispenser 1**
 - Set Tip Priming to **Before this dispense step** and Volume to **10 µL**.
 - Set the Dispense Volume to **100 µL** (or an amount to match your assay protocol).
 - Select a **Rate** (adjust the rate to support the dispensing volume).
 - Click **OK** to close the dialog and add the Dispense step to the list.
3. Add another Dispense step with the same parameters, selecting **Dispenser 2**.
4. Add a quick Read step with the following parameters (Gen5 requires that a Read step follow the Dispense step):
 - Define a **partial plate** read on just one well (e.g., A1)
 - Set the Detection Method to **Absorbance**
 - Set the Read Type to **Endpoint**
 - Set the Read Speed to **Normal**
 - Select any **wavelength**
5. Click **OK** to close the dialog and add the Read step to the list.
6. Click **OK** to close the Procedure.
7. Save the protocol with an identifying name, such as “Dispense Observation.”
8. Create a new experiment to run the Dispense Observation protocol.
9. Initiate the plate read and follow the prompts.

10. When the procedure is complete, visually assess the fluid level in the wells for accuracy. If the well volume appears to be unevenly distributed, clean the internal dispense tubes and injector heads as described in **Cleaning Internal Components** on page 60.

Empty/Clean the Tip Priming Trough

Applies only to Synergy HTX models with injectors.

The tip priming trough is a small, removable priming cup located in the left rear of the microplate carrier, used for performing the Tip Prime. The trough holds about 1.5 mL of liquid and must be periodically emptied and cleaned by the user.

To empty/clean the tip prime trough:

1. Extend the microplate carrier and carefully remove the tip priming trough from its pocket in the left rear of the carrier.
2. Wash the trough in hot, soapy water. Use a small brush to clean in the corners.
3. Rinse the trough thoroughly and allow it to dry completely.
4. Replace the trough in the microplate carrier.

When starting a Gen5 experiment that includes dispensing, Gen5 will prompt you to empty the tip prime trough. Follow the instructions provided.

Clean the Priming Plate

Applies only to Synergy HTX models with injectors.

Clean the priming plate regularly to prevent bacteria growth and residue buildup. Wash the plate in hot soapy water, using a small brush to clean in the corners if necessary. Rinse thoroughly and allow it to dry completely.

Clean the Internal Components

Applies only to Synergy HTX models with injectors.

The Synergy HTX's internal components that require routine cleaning include:

- Optical probes
- Surface beneath the microplate carrier
- Internal dispense tubes and injector heads

The internal components should be cleaned at least *quarterly*. In addition, if fluid has spilled inside the instrument and/or if an unusually high background signal has been flagged by the assay controls (typically blanks or negative controls), the optical probes and the surface beneath the microplate carrier should be cleaned.

❖ The procedures in this section should be performed in succession. Start with **Removing the Reader's Shroud** and execute the procedures that meet your needs, in the order in which they are presented. Finish with **Reassembling the Components**.

We recommend running a System Test in Gen5 before and after performing these cleaning procedures. This will verify that all systems are functioning properly and allow you to compare results before and after maintenance.



Caution! The buildup of deposits left by the evaporation of spilled fluids within the read chamber can impact performance of both the fluorescence and absorbance functions. Be sure to perform a System Test before and after maintenance so that any changes in performance can be noted.

Required Materials



Warning! Always wear protective gloves and safety glasses when performing cleaning/maintenance procedures.

For all tasks:

- Protective gloves
- Safety glasses

For removing the shroud and some of the internal components:

- Screwdriver
- 1/8" hex key
- 3/32" hex key

For cleaning the internal dispense tubes and injector heads, as well as for wiping the surface under the plate carrier:

- Mild detergent
- Clean, lint-free cotton cloths
- Deionized or distilled water
- Stylus (stored in a plastic cylinder affixed to the rear of the dispense module or reader) (PN 2872304)

For cleaning the optical probes:

- Clean cotton swabs
- Isopropyl alcohol
- Lens-cleaning tissue

Removing the Reader's Shroud



Caution! Before removing the shroud: Purge the dispense module (see page 57 for instructions), and then turn off and disconnect the reader from its power supply, the PC, and the dispense module.

The reader's shroud (cover) must be removed to expose the internal components.

1. If you have not already done so, purge the dispense module of fluid.
2. Clear the work surface around the reader so you can easily access all sides of the instrument.
3. Disconnect power and all cables. Set the dispense module aside.
4. Remove four black mounting screws: one at the bottom rear corner on each side, and two at the top center of the rear panel.

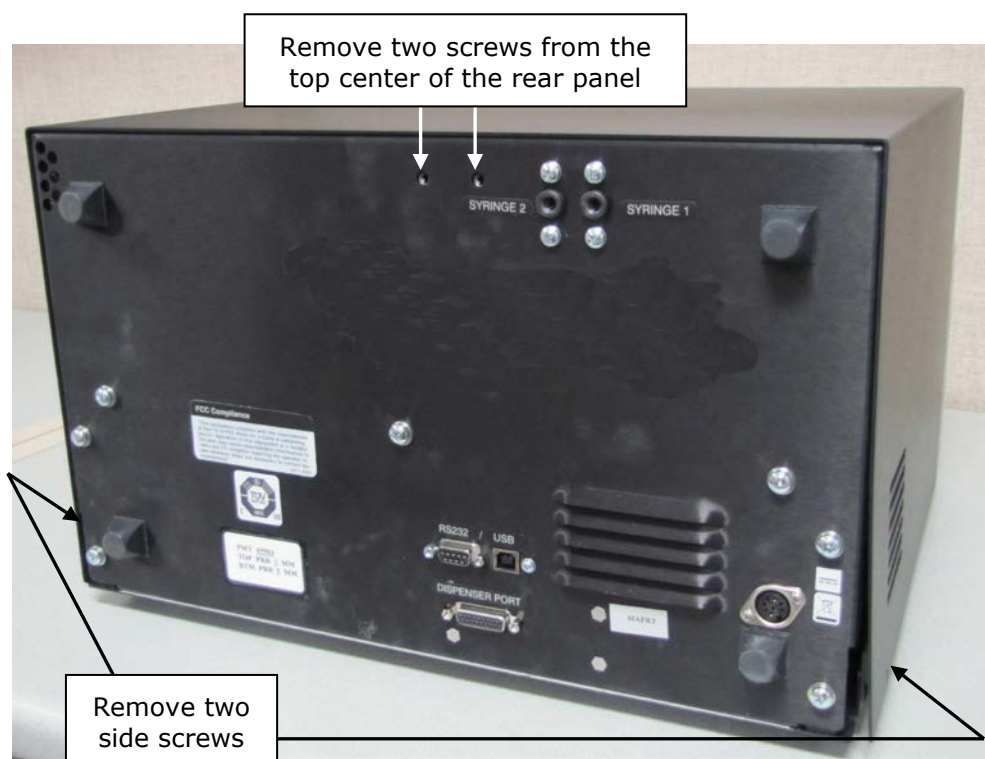

❖ When reinstalling the shroud, press down firmly on the top to maintain a good seal while tightening the top screws.

5. Stand facing the front of the instrument. Grasp both sides of the shroud, slide it toward you, and pull it straight off the instrument. Set the shroud aside.



Removing the Internal Tubes and Injector Heads

Take a moment to identify the components described in this section:

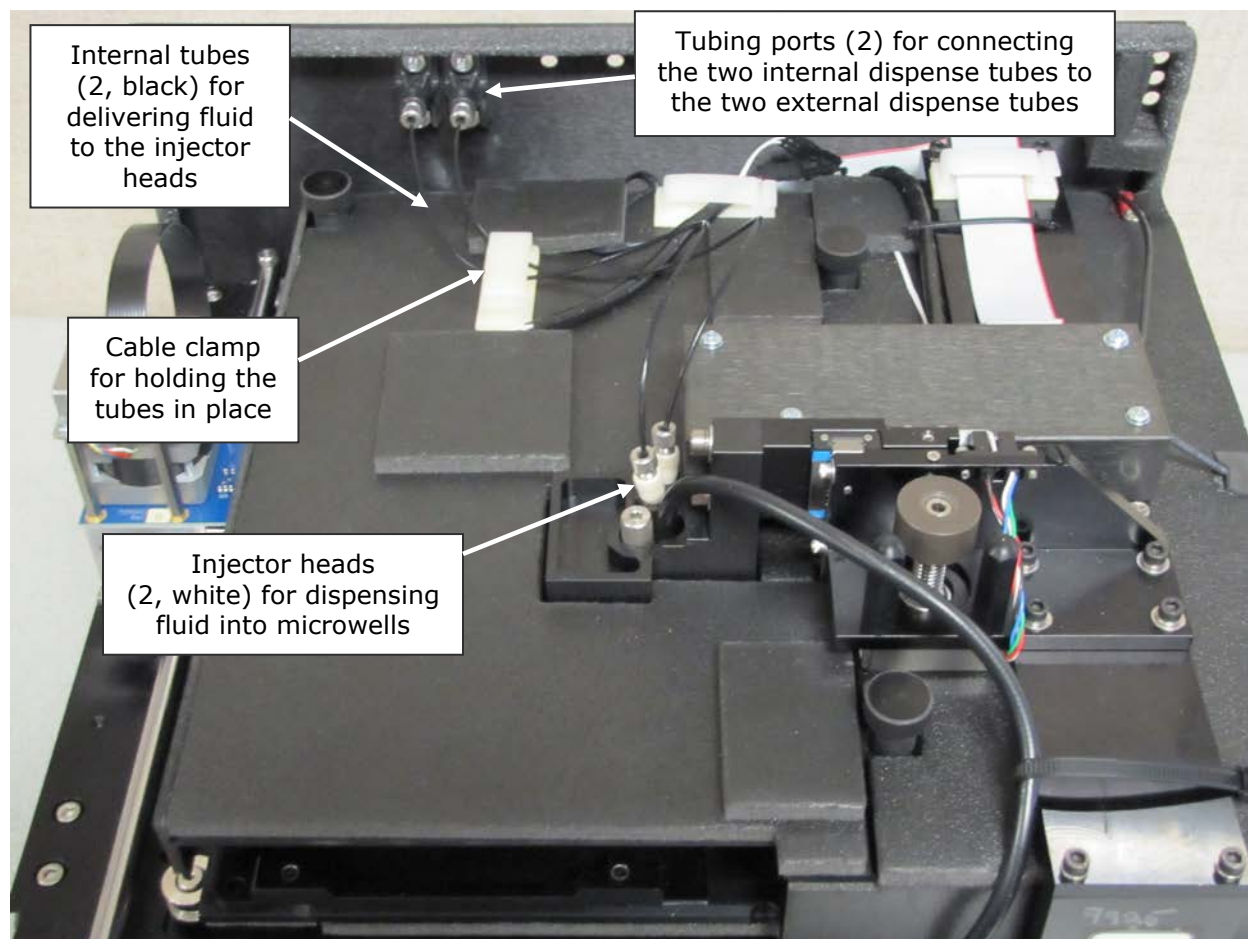
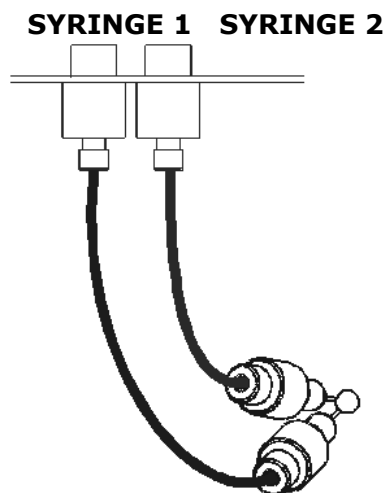

Figure 20: Internal components for the injection system



Important! When reinstalling the internal dispense tubes, be sure to align the tubing ports with the injector heads as shown in this diagram. Look for the **SYRINGE 1** and **SYRINGE 2** labels on the instrument's rear panel.



Perform these steps to remove both sets of internal dispense tubes and injector heads:

1. Open the cable clamp to release the tubes.
2. Locate the tubing ports on the reader's rear wall. Turn each tube's thumbscrew counterclockwise and gently pull the tube from the port.

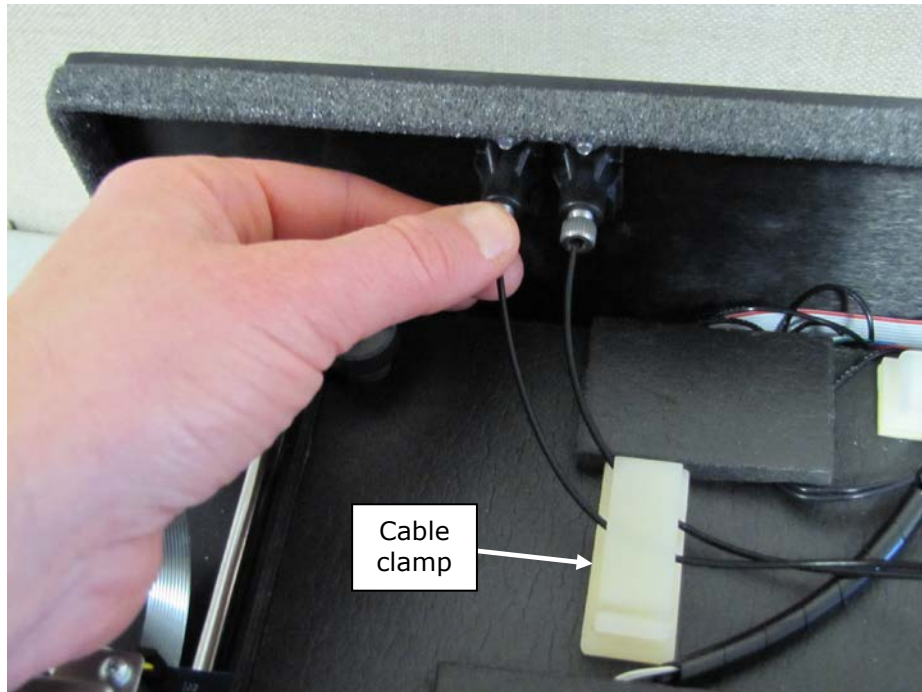

3. Locate the injector heads. Turn each tube's thumbscrew counterclockwise to disconnect the tube from the injector head.

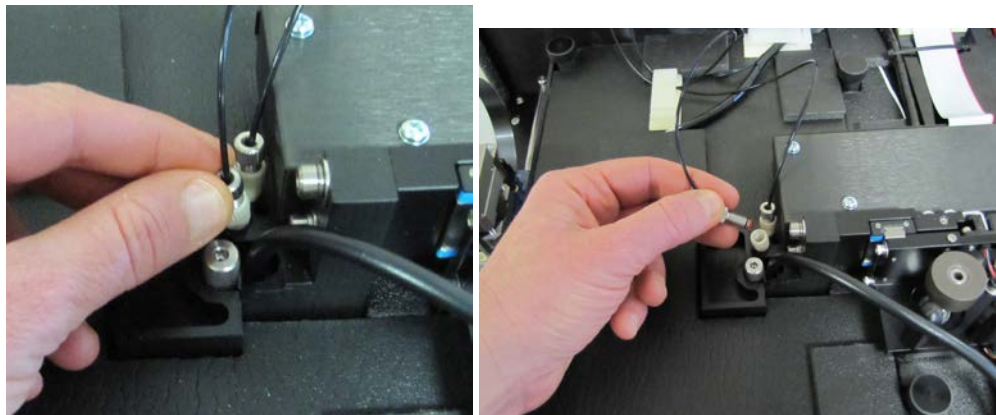

4. Turn the injector heads counterclockwise and gently pull them out of their sockets.

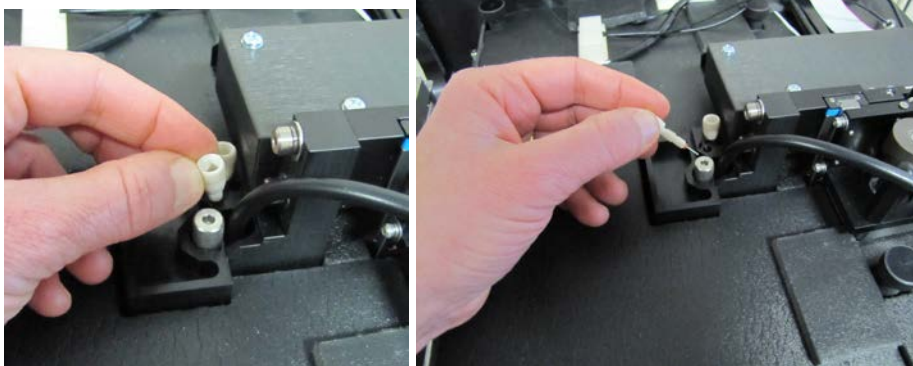

❖ Be sure to seat the injector tips securely when reinstalling. See the photo on page 77.

Cleaning the Internal Tubes and Injector Heads

As discussed on page 52, some reagents can crystallize and clog the tubing and injector heads.

Daily flushing and purging can help to prevent this, but more rigorous cleaning may be necessary if reagent has been allowed to dry in the tubing and/or injectors.

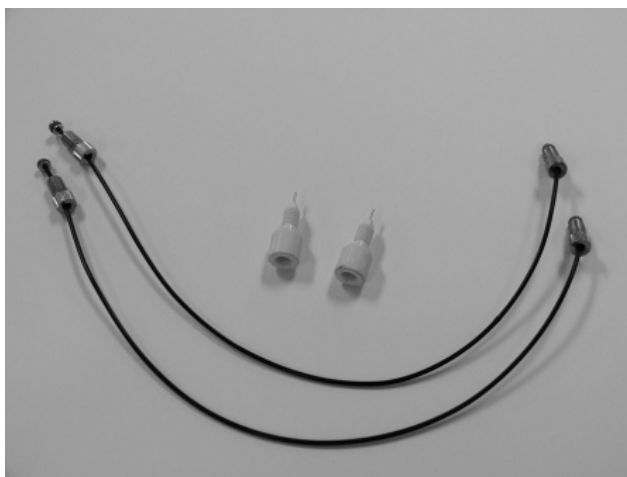

To clean the tubes:

1. Soak the internal tubes in hot soapy water to soften and dissolve any hardened particles.
2. Flush each tube by holding it vertically under a stream of water from a faucet.

To clean the injector heads:

❖ Do not remove the o-ring from the injector head (see photos below).

1. Gently insert the stylus into each injector head pipe to clear any blockages. (The stylus should be stored in a plastic cylinder affixed to the rear of the dispense module or reader.)
2. Stream water from a faucet through the pipe to be sure it is clean. If the water does not stream out, try soaking the heads in hot soapy water and then reinserting the stylus.

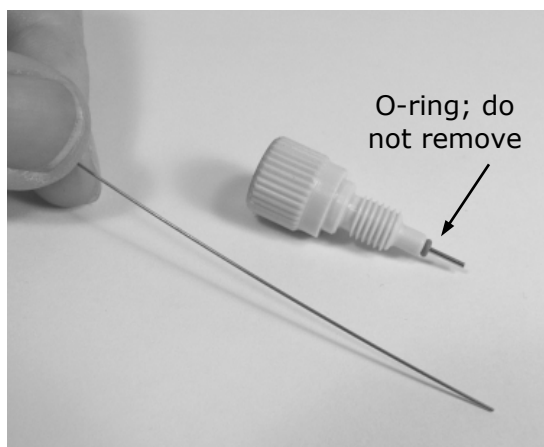

Cleaning the Optical Probes

The optical probes should be cleaned at least *quarterly*. They should also be cleaned if reagent has spilled and/or if an unusually high background signal has been flagged by the assay controls (typically blanks or negative controls).

Contaminated probes can lead to a loss of sensitivity (e.g., instead of being able to meet the 10 pg/mL concentration detection limit, the instrument may only be able to meet 20 pg/mL). Another indicator is the %CV in the Corners liquid test – it may increase due to the “Noise” in the chamber from any spilled fluorescing compounds.

- To access the optical probes, the first step is to unplug the reader and remove its shroud (cover). If you haven't already done this, turn to page 62 now for instructions.
- We recommend cleaning the internal tubes and injector heads along with the optical probes. Instructions for removing and cleaning these components are provided on pages 64 through 67.
- Before starting this procedure, gather some supplies:
 - Small container of isopropyl alcohol
 - Small container of deionized or distilled water
 - Lens-cleaning tissue
 - Cotton swabs

Take a moment to identify the components discussed in this section:

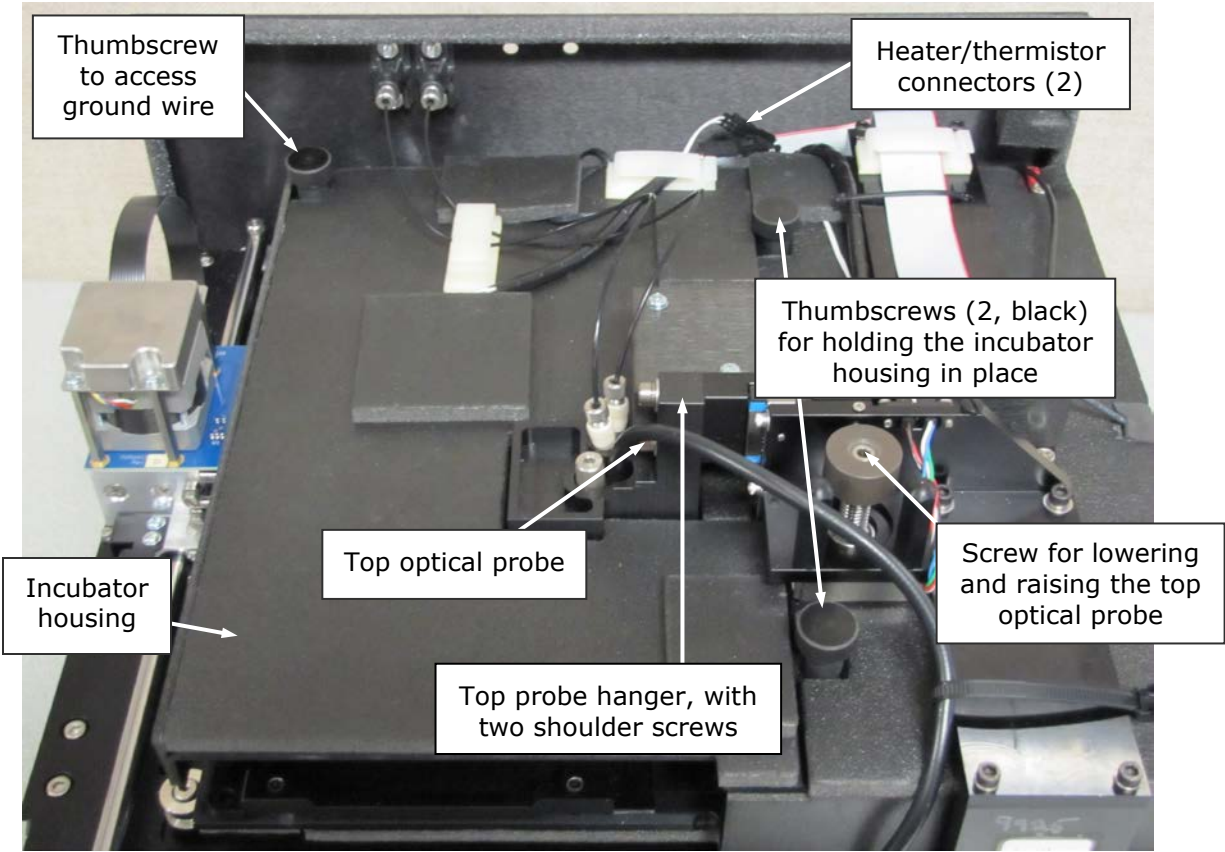
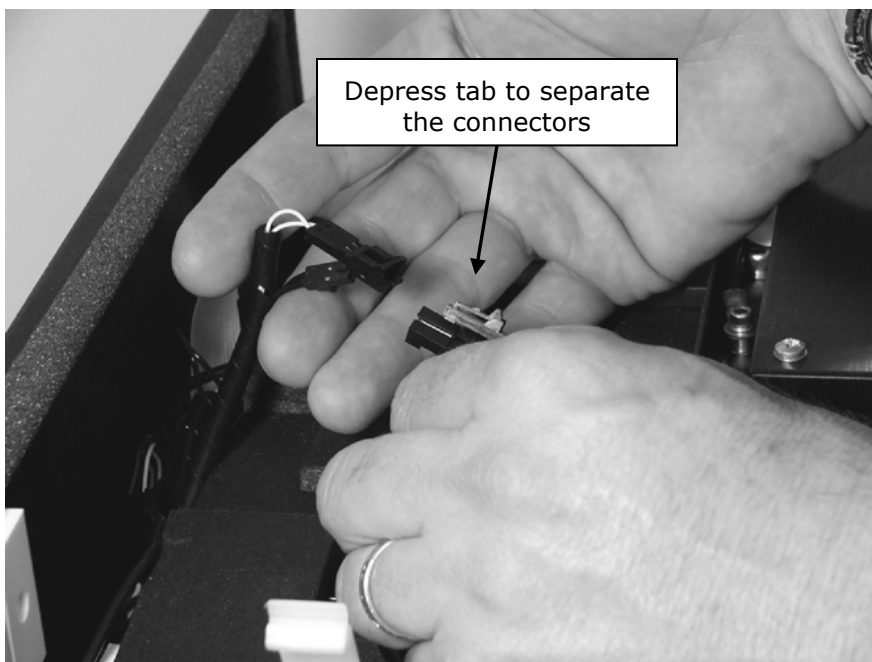

Figure 21: Internal components to be removed/adjusted for cleaning the optic probes

Once the shroud has been removed and the internal tubes and injector heads have been removed and cleaned (see page 67), follow these instructions to remove a few more components and then clean the optical probes:

1. Disconnect the heater and thermistor wires. To do this, depress the small tab (pictured below) and separate the connectors.



2. Remove the thumbscrew located in the left rear of the instrument and set it aside. This exposes the ground wire.



3. Lift the ground wire and move it off to the side.



4. Locate the two black thumbscrews that hold the incubator housing in place. Remove both of them and set them aside.

5. Turn the top probe screw counterclockwise to lower the probe hanger all the way to the bottom. (Rotate the screw, not the ring around it.)

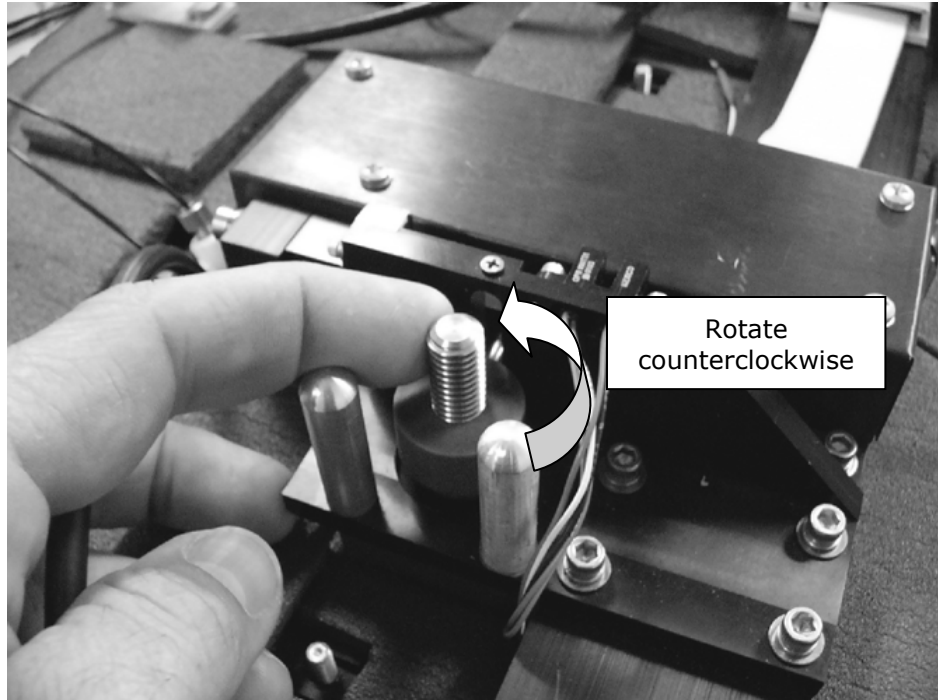

6. Gently lift the left side of the incubator housing and carefully slide it out.

Note:

When replacing the incubator housing, the two "forks" on its right side should wrap around the holding screws.

The forks should not slide under the fixed foam housing.

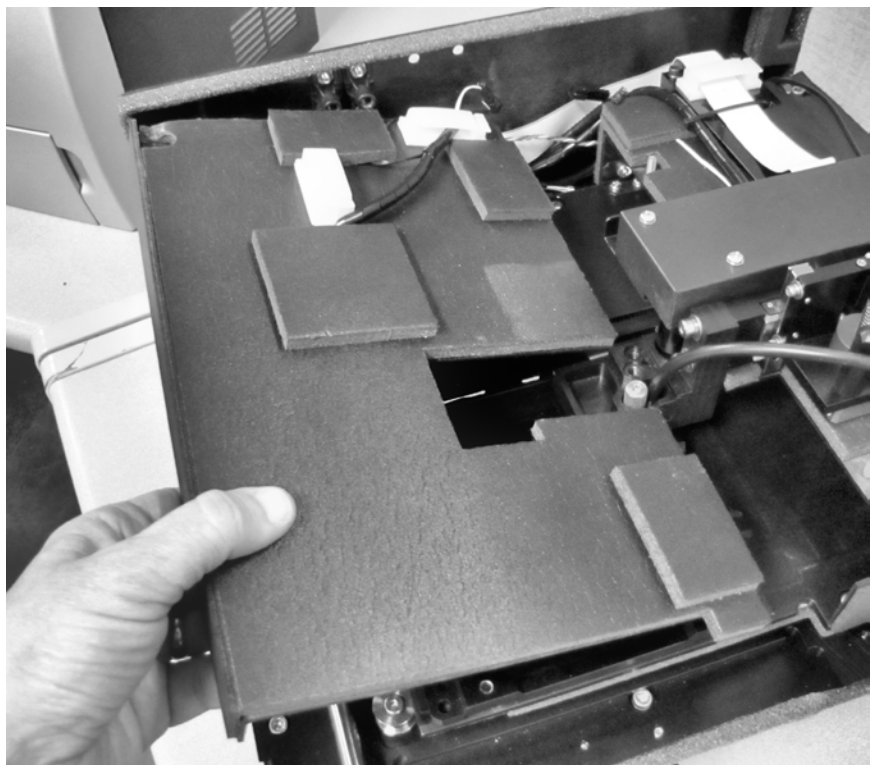

7. Use a 1/8" hex key to remove the top optical probe's holding screw.

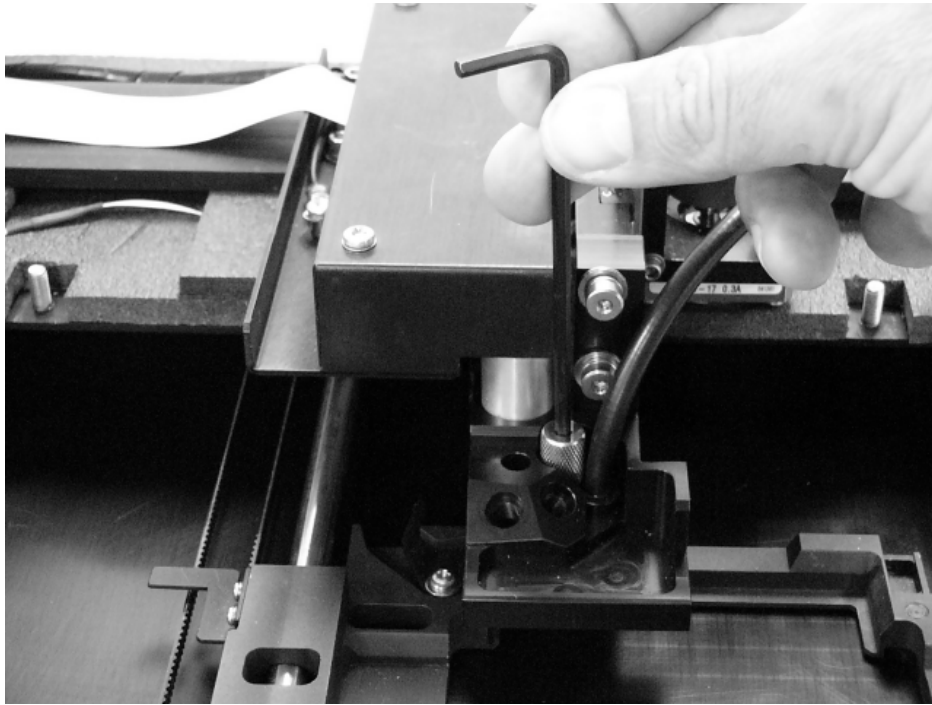

8. Gently pull the optical probe up and out of its socket to expose it for cleaning. Soak the end of the probe in alcohol for one minute **maximum**. Wipe with lens-cleaning tissue and set aside.

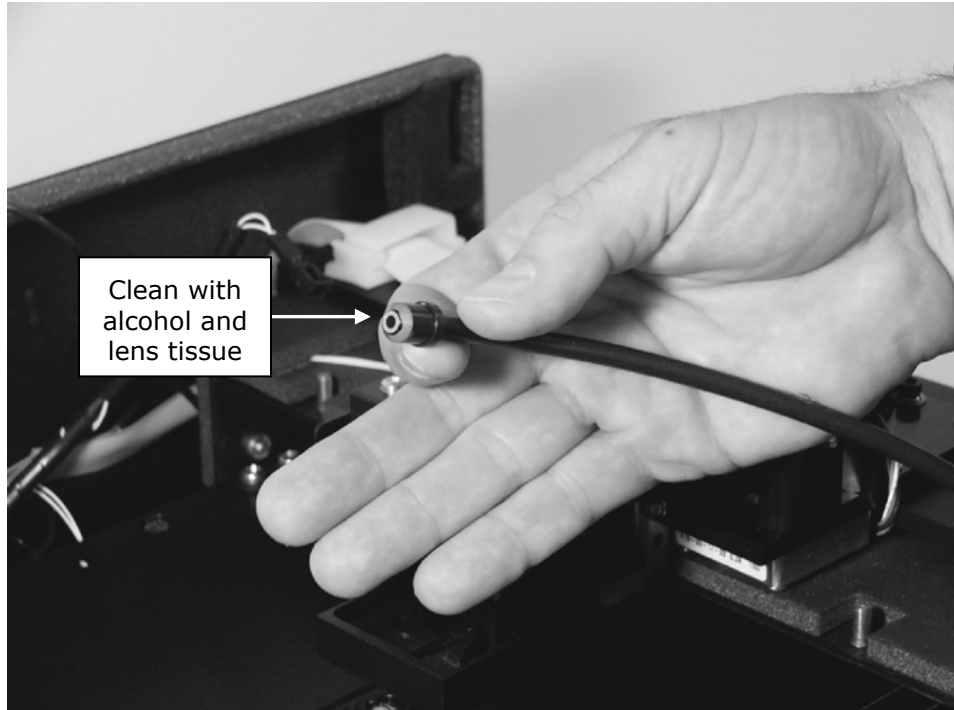

9. Use a 3/32" hex key to remove the two shoulder screws securing the top probe hanger. Remove the screws and set them aside.

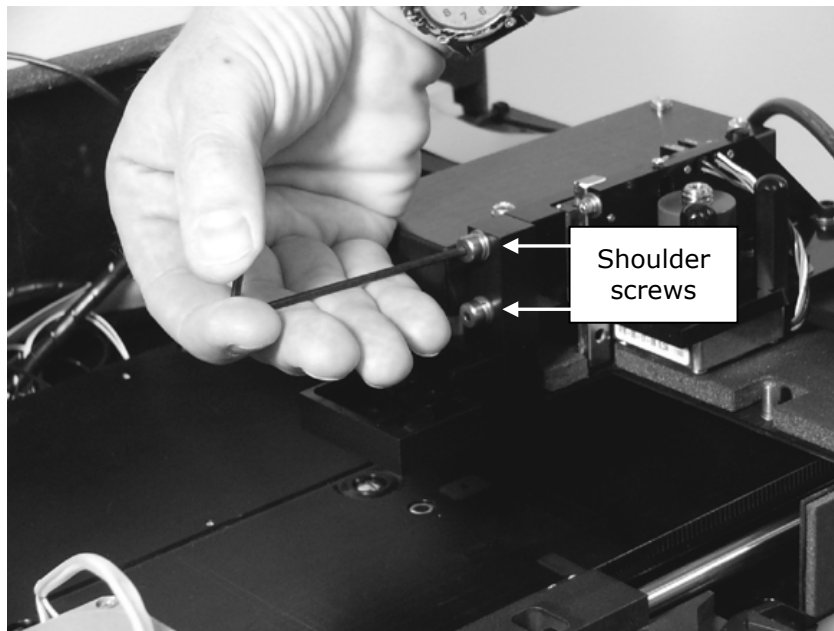

10. Drop the top probe hanger down and slide to the left to remove it. Turn the hanger upside down to clean the absorbance lens (see instructions on the next page). **Do not touch the lens with your fingers!** Inspect the block for spills or other contamination. *Carefully* clean with mild detergent if necessary.

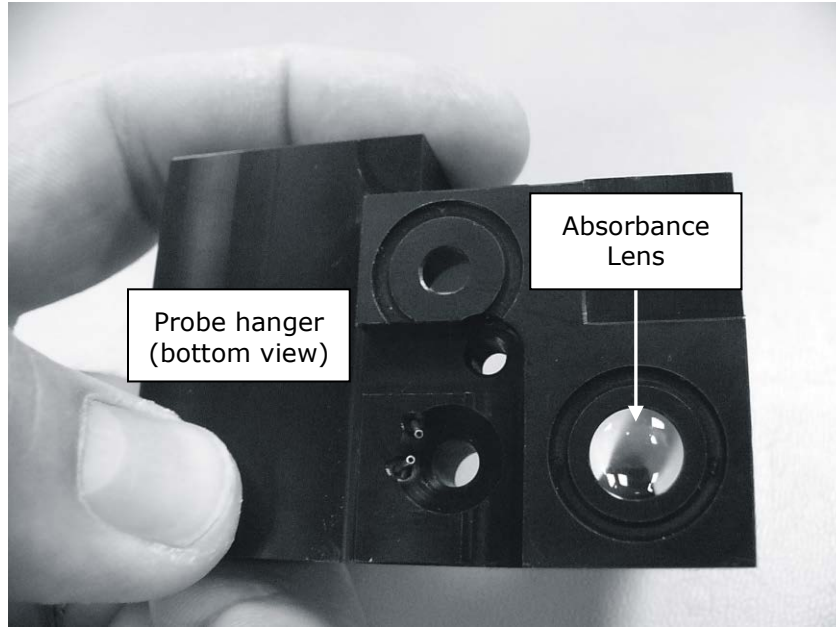

❖ **Important!** When cleaning the absorbance lens with the swab, apply very little pressure to the lens! Applying too much pressure can push the lens out of its holder; reinstallation must be performed by BioTek service personnel. If the lens does fall out, contact BioTek TAC.

11. Use a cotton swab moistened with alcohol to **gently** clean the lens on the top probe hanger.



12. Slide the microplate carrier out of the way. Use a cotton swab moistened with alcohol to clean the lens on the instrument surface.



Cleaning the Reader's Internal Surface

1. If you have not already done so, unplug the instrument and remove its shroud (see page 62 for instructions). Follow the instructions under **Cleaning the Optical Probes** to (at a minimum) disconnect the incubator wires, detach the ground wire, lower the top optic probe hanger, and remove the incubator housing (steps 1 through 6).
2. Manually slide the microplate carrier to the left to engage the support pin, and then away from the center surface.

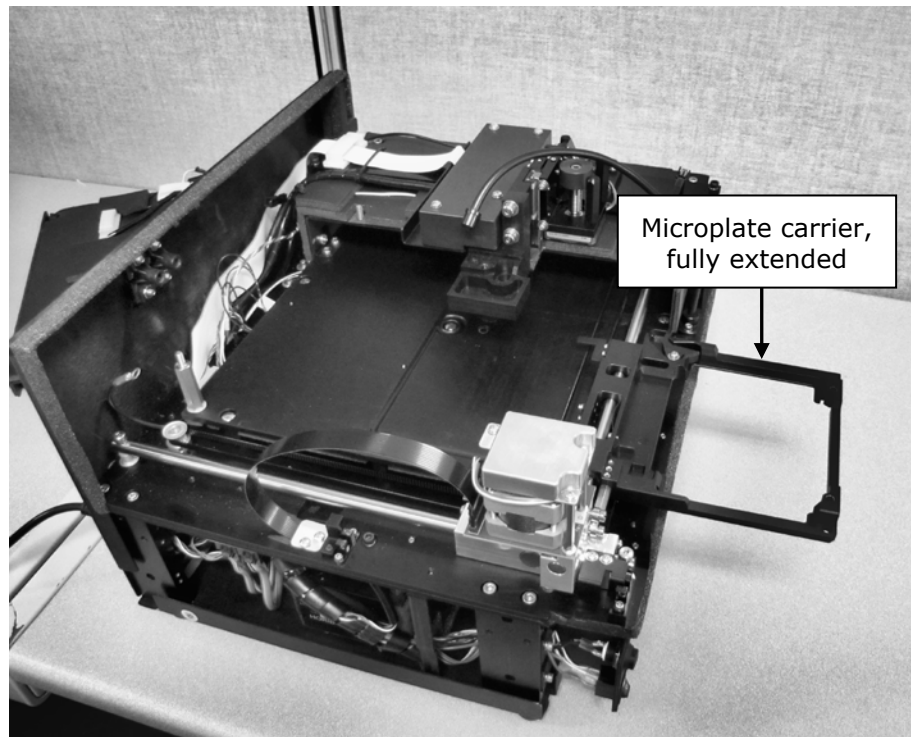

3. Moisten (**do not soak**) a clean cotton cloth with alcohol, water, or with water and mild detergent. Wipe all sides of the plate carrier. Wipe the instrument's horizontal surface.



4. If detergent was used, wipe the surfaces with a cloth moistened with water.
5. Use a clean, dry, lint-free cloth to dry all wet surfaces.

Reassembling the Components

Perform these steps in the order listed to reassemble the components. Refer to the page numbers shown for further instructions and photos demonstrating the steps.

1. Slide the microplate carrier back into the instrument, page 76.
2. Insert the two injector heads into their sockets in the top probe hanger.
Do not touch the absorbance lens with your fingers! Ensure that the injector heads are properly seated in the hanger. The knurled plastic should sit flush against the hanger surface, as shown below.



3. Attach the two internal dispense tubes to the injector heads, as shown below. **Do not overtighten the thumbscrews!**



Here is the top probe hanger ready for reinstallation, with injector heads and internal dispense tubes attached:

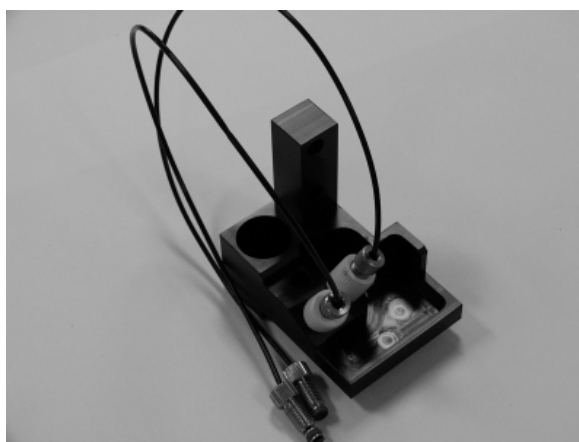

4. Replace the top probe hanger and shoulder screws (using the 3/32" hex key), page 74.

5. Insert the top optic probe into its socket and replace its holding screw (using the 1/8" hex key), page 73.
6. Replace the incubator housing and two thumbscrews, pages 72 and 71. Do not slide the two "forks" on the housing's right side *under* the fixed foam housing.
7. Replace the groundwire and its thumbscrew, page 70.
8. Reconnect the heater and thermistor wires, page 70. Be sure to connect wires of the same color.
9. Attach the two internal dispense tubes to the tubing ports, taking care to align the correct port with the correct injector head, page 65.
10. Slide the two internal dispense tubes into the cable clamp and close the clamp, page 65.
11. Review the steps you just performed to make sure the components have been properly reassembled.
12. Slide the shroud onto the instrument, page 63.
13. Replace the four screws to securely attach the shroud to the base, page 62.

Performance Check

After reassembling the instrument, perform the following to verify that the instrument is functioning properly:

- Plug the instrument in and turn it on; allow its run-time system test to complete. Run a System Test through Gen5.
- Run any required OQ/PQ tests.

Chapter 5

As-Needed Maintenance

This appendix contains procedures for decontaminating all models of the Synergy HTX.



Purpose	82
Required Materials.....	83
Procedure for Models without Injectors.....	84
Routine Procedure for Models with Injectors.....	85
Clean Exposed Surfaces.....	85
Decontaminate the Fluid Lines	86
Rinse the Fluid Lines	87
Clean the Internal Tubing and Injector Heads	87
Clean the Tip Priming Trough and Priming Plate	88
Alternate Procedure for Models with Injectors.....	89

Purpose

Any laboratory instrument that has been used for research or clinical analysis is considered a biohazard and requires decontamination prior to handling.

Decontamination minimizes the risk to all who come into contact with the instrument during shipping, handling, and servicing. Decontamination is required by the U.S. Department of Transportation regulations.

Persons performing the decontamination process must be familiar with the basic setup and operation of the instrument.

	<p>BioTek Instruments, Inc. recommends the use of the following decontamination solutions and methods based on our knowledge of the instrument and recommendations of the Centers for Disease Control and Prevention (CDC). Neither BioTek nor the CDC assumes any liability for the adequacy of these solutions and methods. Each laboratory must ensure that decontamination procedures are adequate for the Biohazard(s) they handle.</p>
	<p>Wear prophylactic gloves when handling contaminated instruments. Gloved hands should be considered contaminated at all times; keep gloved hands away from eyes, mouth, and nose. Eating and drinking while decontaminating instruments is not advised.</p>
	<p>Mucous membranes are considered prime entry routes for infectious agents. Wear eye protection and a surgical mask when there is a possibility of aerosol contamination. Intact skin is generally considered an effective barrier against infectious organisms; however, small abrasions and cuts may not always be visible. Wear protective gloves when performing the decontamination procedure.</p>

Required Materials



For all Synergy HTX models:

- Sodium hypochlorite (NaClO, or bleach)
- 70% isopropyl alcohol (as an alternative to bleach)
- Deionized or distilled water
- Safety glasses
- Surgical mask
- Protective gloves
- Lab coat
- Biohazard trash bags
- 125 mL beakers
- Clean, lint-free cotton cloths

Additional materials for models with injectors:

- Screwdriver
- Small brush for cleaning the tip priming trough and priming plate
- (Optional) Mild detergent

Procedure for Models without Injectors

	<p>The sodium hypochlorite (bleach) solution is caustic; wear gloves and eye protection when handling the solution.</p> <p>Do not immerse the instrument, spray it with liquid, or use a “wet” cloth. Do not allow the cleaning solution to run into the interior of the instrument. If this happens, contact the BioTek Service Department.</p>
	<p>Important! Turn off and unplug the instrument for all decontamination and cleaning operations.</p>

1. Turn off and unplug the instrument.
2. Prepare an aqueous solution of 0.50% sodium hypochlorite (bleach). As an alternative, 70% isopropyl alcohol may be used if the effects of bleach are a concern.

❖ Be sure to check the percent NaClO of the bleach you are using; this information is printed on the side of the bottle. Commercial bleach is typically 10.0% NaClO; if this is the case, prepare a 1:20 dilution. Household bleach is typically 5.0% NaClO; if this is the case, prepare a 1:10 dilution.

3. Moisten a cloth with the bleach solution or alcohol. **Do not soak the cloth.**
4. Manually open the plate carrier door; slide out the plate carrier.
5. Wipe the plate carrier and all exposed surfaces of the instrument.
6. Wait 20 minutes. Moisten a cloth with deionized (DI) or distilled water and wipe all surfaces of the instrument that have been cleaned with the bleach solution or alcohol.
7. Use a clean, dry cloth to dry all wet surfaces.
8. Reassemble the instrument as necessary.
9. Discard the used gloves and cloths using a biohazard trash bag and an approved biohazard container.

Routine Procedure for Models with Injectors

❖ Perform this **Routine Procedure** when all systems are functioning normally on the Synergy HTX with Injectors. If you are unable to prime the Synergy HTX due to a system failure, perform the **Alternate Procedure** described on page 89.



If disinfecting with sodium hypochlorite (bleach), be sure to flush repeatedly with deionized water to ensure that no bleach is carried over. After disinfecting with sodium hypochlorite, perform the rinse procedure provided on page 87.

If disinfecting with alcohol, do not immediately prime with deionized water, because the drying effect of the alcohol is an important aspect of its disinfectant properties.

Clean Exposed Surfaces

1. Turn off and unplug the instrument.
2. Prepare an aqueous solution of 0.50% sodium hypochlorite (bleach). As an alternative, 70% isopropyl alcohol may be used if the effects of bleach are a concern.

❖ Be sure to check the percent NaClO of the bleach you are using; this information is printed on the side of the bottle. Commercial bleach is typically 10.0% NaClO; if this is the case, prepare a 1:20 dilution. Household bleach is typically 5.0% NaClO; if this is the case, prepare a 1:10 dilution.

3. Manually open the plate carrier door; slide out the plate carrier.
4. Moisten a cloth with the bleach solution or alcohol. **Do not soak the cloth.**
5. Wipe the plate carrier and the exposed surfaces of the external dispense module.
6. Wait 20 minutes. Moisten a cloth with deionized (DI) or distilled water and wipe all surfaces that have been cleaned with the bleach solution or alcohol.
7. Use a clean, dry cloth to dry all wet surfaces.

8. Reassemble the instrument as necessary.
9. If the dispense module is installed, detach the outlet tubes from the rear panel of the instrument. If it is not installed, attach just the dispense module's communication cable to the instrument. Remove the supply bottles and their holders.
10. Perform the procedures described below through page 88 to decontaminate the fluid lines in the dispense module, the internal tubing and injector heads, and the tip priming trough and priming plate.

Decontaminate the Fluid Lines

1. Place a beaker with 20 mL of 0.5% sodium hypochlorite solution **or** 70% isopropyl alcohol near SYRINGE 1 on the dispense module.
2. Place the SYRINGE 1 inlet tube in the beaker.
3. If you have not already done so, detach the dispense module's outlet tubes from the instrument's rear panel. Place the ends of the outlet tubes in an empty beaker and set the beaker on the work surface.
4. Launch Gen5, select **System > Instrument Control**, and click the **Prime** tab.
5. Select **Dispenser 1**, enter a Volume of **5000 µL**, and keep the default dispense **Rate**.
6. Place the priming plate on the carrier (it is not used, but the reader requires its presence).
7. Run two prime cycles, for a total of 10000 µL.
8. Pause for 20 to 30 minutes to allow the solution to disinfect the tubing.
9. Remove the inlet tube from the beaker of disinfectant solution.
10. From the Reader Control dialog, change the Volume to **1000 µL**.
11. Run one prime cycle, to flush the disinfectant out of the fluid lines.
12. Empty the beaker containing the outlet tubes. Put the tubes back in.
13. Important! If sodium hypochlorite (bleach) was used, perform **Rinse the Fluid Lines** on the next page.

Otherwise, (or after performing the Rinse procedure), repeat steps 1-13 for SYRINGE 2 / Dispenser 2.

Rinse the Fluid Lines

Perform this procedure only if decontamination was performed using sodium hypochlorite.

1. Place a beaker containing at least 30 mL of deionized water on the dispense module.
2. Place the SYRINGE 1 or 2 inlet tube in the beaker.
3. If you have not already done so, place the outlet tubes in an empty beaker.
4. From the Reader Control dialog, select **Dispenser 1** or **2**, set the Volume to **5000 µL**, and keep the default dispense **Rate**.
5. Run five prime cycles, for a total of 25000 µL.
6. Pause for 10 minutes and then run one prime cycle with 5000 µL. This delay will allow any residual sodium hypochlorite to diffuse into the solution and be flushed out with the next prime.
7. Empty the beaker containing the outlet tubes.
8. Wipe all surfaces with deionized water.
9. Discard the used gloves and cloths using a biohazard trash bag and an approved biohazard container.

Clean the Internal Tubing and Injector Heads

Turn to **Chapter 4, Preventive Maintenance** and perform the following procedures to access, remove, and clean the internal tubing and injector heads:

- **Required Materials**
- **Removing the Reader's Shroud**
- **Removing the Internal Tubes and Injector Heads**
- **Cleaning the Internal Tubes and Injector Heads**

When finished, replace the internal components and the reader's shroud.

Clean the Tip Priming Trough and Priming Plate

1. Remove the tip priming trough from the left rear of the instrument's microplate carrier (see below).
2. Wash the tip priming trough and priming plate in hot, soapy water. Use a small brush or cloth to clean the corners of the trough and plate.
3. To decontaminate, soak the trough and plate in a container of 0.5% sodium hypochlorite **or** 70% isopropyl alcohol for 20 to 30 minutes.
4. If decontaminating in bleach solution, remove the trough and plate, and thoroughly rinse with DI water.
If decontaminating with alcohol, remove the trough and plate and let them air-dry.
5. Discard the used gloves and cloths using a biohazard trash bag and an approved biohazard container.

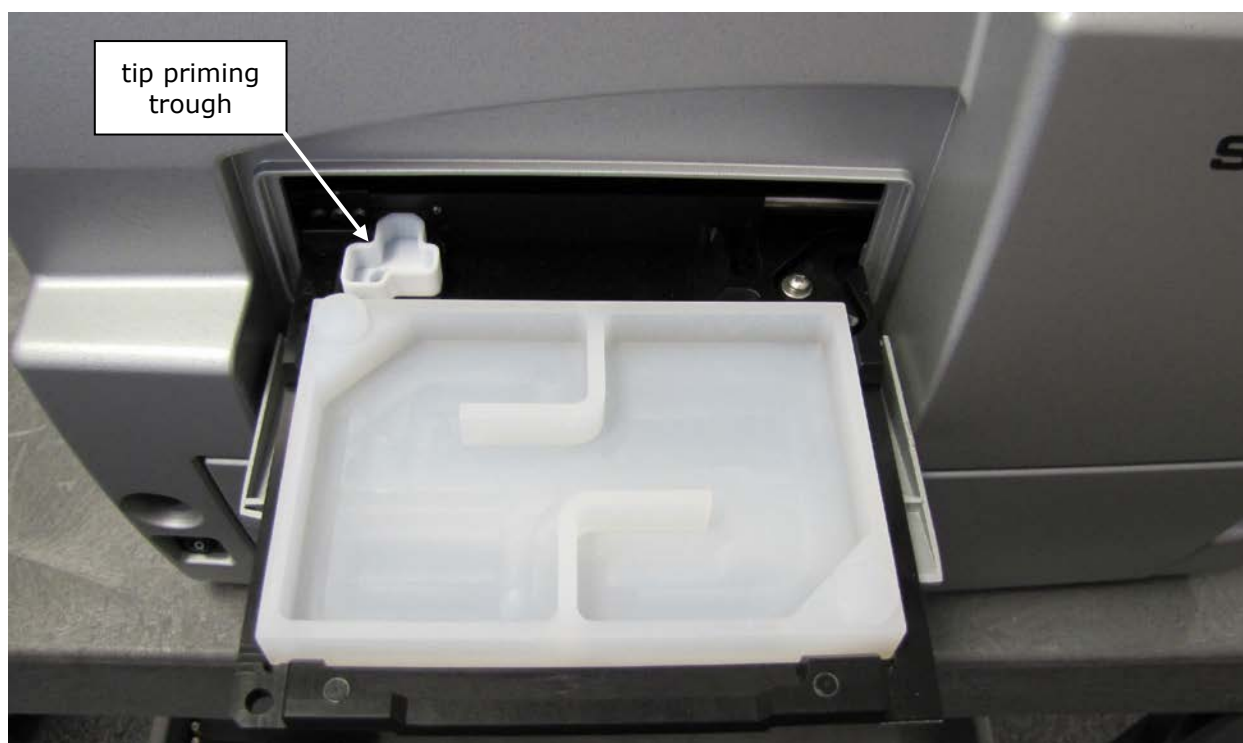

Figure 33: Tip priming trough and priming plate

Alternate Procedure for Models with Injectors

If you are unable to prime the Synergy HTX due to a system failure, decontaminate the instrument and the Dispense Module as follows:

1. Turn to **Chapter 4, Preventive Maintenance** and perform the following procedures to remove the shroud and remove/clean the internal tubes and injector heads. When finished, leave the shroud off the reader and proceed to step 2 below.
 - **Required Materials**
 - **Removing the Reader's Shroud**
 - **Removing the Internal Tubes and Injector Heads**
 - **Cleaning the Internal Tubes and Injector Heads**
2. Prepare an aqueous solution of 0.50% sodium hypochlorite (bleach). As an alternative, 70% isopropyl alcohol may be used if the effects of bleach are a concern.

❖ Be sure to check the percent NaClO of the bleach you are using; this information is printed on the side of the bottle. Commercial bleach is typically 10.0% NaClO; if this is the case, prepare a 1:20 dilution. Household bleach is typically 5.0% NaClO; if this is the case, prepare a 1:10 dilution.

3. Slide the microplate carrier out of the instrument.
4. Moisten a cloth with the bleach solution or alcohol. **Do not soak the cloth.**
5. Use the cloth to wipe:
 - All surfaces of the shroud
 - All surfaces of the plate carrier
 - The instrument's rear panel
 - The exposed surfaces of the dispense module, including the syringe valves
6. Remove the external tubing and the syringes from the dispense module and soak them in the bleach or alcohol solution. **Wait for 20 minutes.**

❖ **To remove the syringes:** In Gen5, click **System > Instrument Control**. On the Prime tab, click **Maintenance**. Pull down the syringe bracket until it stops. Remove the metal thumbscrew from underneath the bracket. Unscrew the top of the syringe from the bottom of the syringe drive. Gently remove the syringe and store it in its original packaging (see **Chapter 2, Installation**).

7. Moisten a cloth with DI or distilled water and wipe all surfaces that have been cleaned with the bleach solution or alcohol.

8. Rinse all tubing and the syringes with DI water.
9. Use a clean, dry cloth to dry all wet surfaces on the instrument and the Dispense module.
10. Reassemble the instrument and dispense module as necessary.
11. Discard the used gloves and cloths using a biohazard trash bag and an approved biohazard container.

Chapter 6

Instrument Qualification

This chapter contains procedures for qualifying the initial and ongoing performance of the Synergy HTX and the external dispense module (if used).

Overview	92
IQ/OQ/PQ.....	92
Recommended Qualification Schedule	94
System Test	95
Absorbance Plate Test.....	100
Luminescence Tests.....	106
Absorbance Liquid Tests.....	109
Fluorescence Tests	116
Dispense Module Tests.....	132

Overview

This chapter contains BioTek Instruments' recommended Installation Qualification (IQ), Operational Qualification (OQ), and Performance Qualification (PQ) procedures for all models of the Synergy HTX Multi-Mode Microplate Reader.

Every Synergy HTX reader and external dispense module is fully tested at BioTek prior to shipment and they should operate properly upon initial setup. If you suspect that a problem occurred during shipment, if you have received the equipment after returning it to the factory for service, and/or if regulatory requirements dictate that you qualify the equipment on a routine basis, you should perform the procedures outlined in this chapter.

❖ A **Product Qualification Package** (PN 1340508) for the Synergy HTX is available for purchase. The package contains complete procedures for performing Installation Qualification, Operational Qualification, Performance Qualification, and Preventive Maintenance procedures. Microsoft Excel spreadsheets are provided for performing the calculations, and checklists, data sheets, and logbooks are provided for recording results. Contact your local BioTek dealer for more information.

IQ/OQ/PQ

Installation Qualification confirms that the reader and its components have been supplied as ordered and ensures that they are assembled and configured properly for your lab environment.

- The recommended IQ procedure consists of setting up the instrument and its components as described in **Chapter 2, Installation** and performing the System Test. For models with injectors, a quick "Injector Test" is also performed, to ensure that the dispense module is properly installed and there are no leaks.
- The IQ procedure should be performed *initially* (before the reader is used for the first time).
- The successful completion of the IQ procedure verifies that the instrument is installed correctly. The Operational Qualification procedure should be performed immediately following the successful IQ.

Operational Qualification confirms that the equipment operates according to specification initially and over time.

- The recommended OQ procedure consists of performing the System Test, Absorbance Plate Test, a series of Liquid Tests, and, if the external dispense module is used, the Dispense Accuracy and Precision Tests.
- The OQ procedure should be performed *initially* (before first use) and then routinely; the recommended interval is *annually*. It should also be performed after any major repair or upgrade to the hardware or software.
- Although out-of-tolerance failures will be detected by the OQ tests, results should be compared with those from the routine Performance Qualification tests and previous OQ tests to monitor for trends.
- The successful completion of the OQ procedure, in combination with results that are comparable to previous PQ and OQ tests, confirms that the equipment is operating according to specification initially and over time.

Performance Qualification confirms that the reader consistently meets the requirements of the tests performed at your laboratory.

- The recommended PQ procedure consists of performing the System Test, Absorbance Plate Test, a series of Liquid Tests, and, if the external dispense module is used, the Dispense Accuracy and Precision Tests.
- Your facility's operating policies may also require that you routinely perform an actual assay, to confirm that the reader will consistently give adequate results for the assays to be run on it.
- These tests should be performed routinely; the recommended interval is *monthly* or *quarterly*, depending on the test. This frequency may be adjusted depending on the trends observed over time.
- The successful completion of the PQ procedure confirms that the equipment is performing consistently under normal operating conditions.

Recommended Qualification Schedule

The schedule below defines the factory-recommended intervals for qualifying a Synergy HTX used two to five days a week. The actual frequency, however, may be adjusted depending on your usage of the instrument. This schedule assumes the reader is properly maintained as outlined in **Chapter 4, Preventive Maintenance**.

Tests	IQ	OQ	PQ	
	Initially	Initially/ Annually	Monthly	Quarterly
System Test	✓	✓	✓	
Absorbance Tests*				
Absorbance Plate Test		✓	✓	
Liquid Test 1 <u>or</u> Liquid Test 2**		✓		✓
Liquid Test 3***		✓		✓
Fluorescence Tests				
Corners Test		✓	✓	
Sensitivity/Linearity Tests		✓	✓	
Tests for Injector Models				
Injector System Test	✓			
Dispense Accuracy and Precision Tests		✓		✓

* If applicable to your reader model

** Regarding Liquid Tests 1 and 2:

- If you have an Absorbance Test Plate, run Liquid Test 1.
- If you do not have an Absorbance Test Plate, run Liquid Test 2.

*** Liquid Test 3 is optional; it is provided for sites requiring verification at wavelengths lower than those attainable with the Absorbance Test Plate.



Important! The risk factors associated with your assays may require that the Operational and Performance Qualification procedures be performed more frequently than shown above.

System Test

Each time the Synergy HTX is turned on, it automatically performs a series of tests on the reader's motors, lamp, the PMT, and various subsystems. The duration of this system test depends on the reader model, and can take a few minutes to complete. If all tests pass, the microplate carrier is ejected and the LED on the power switch remains on.

If any test results do not meet the internally coded Failure Mode Effects Analysis (FMEA) criteria established by BioTek, the reader beeps repeatedly. If this occurs, press the carrier eject button to stop the beeping. If necessary, initiate another system test using Gen5 to try to retrieve an error code from the reader.

Refer to **Appendix B, Error Codes** for information on error codes and for troubleshooting tips.

❖ The system test runs automatically when the instrument is turned on. If this "power-up" system test fails, the instrument will beep repeatedly. If this happens, press the carrier eject button to stop the beeping and then initiate a system test through Gen5 to retrieve the error code.

1. If applicable, adjust Gen5's Absorbance Wavelength table to values that will confirm operation of the reader at its limits. We recommend 200 and 999 nm (the lower and upper limits of the monochromator) and any four wavelengths in between that best represent your assays and/or the lowest and highest wavelength values used in your lab.
 - From Gen5's main screen, select **System > Instrument Configuration**. Highlight **Synergy HTX** and click **View/Modify**.
 - Click **Setup** and then click the **Absorbance** tab. The six wavelength values currently in use are displayed.
 - Enter the six wavelength values you wish to test and then click **Send Wavelengths** to download them to the Synergy HTX.
2. If the reader is equipped with an incubator, select **System > Instrument Control > Synergy HTX** and click the **Pre-Heating** tab. Enter a **Requested** temperature of at least 37°C and then click **On**. Wait until the temperature reaches the set point before continuing.
3. Return to Gen5's main screen. Select **System > Diagnostics > Run System Test**.

❖ If the test fails during execution, a message box will appear in the software. Close the box; the test report will contain the error code that was generated by the failure.

4. When the test is complete, a dialog will appear, requesting additional information. Enter the information (if required) and then click **OK**.

5. The test report will appear; it will show either “SYSTEM TEST PASS” or “SYSTEM TEST FAIL *** ERROR (error code) DETECTED.”
6. Print the report, if required.
 - A sample test report is shown on the next few pages.
 - Gen5 stores the results in a database, so the results can be retrieved/printed at any time. We recommend that you print and save the reports to document that the test was performed.
7. If the test failed, look up the error code in **Appendix B, Error Codes** to determine its cause. If the cause is something you can fix, turn off the reader, fix the problem, and then turn the reader back on and retry the test.

If the test continues to fail, or if the cause is not something you can fix, contact BioTek’s Technical Assistance Center (see page 6 for contact information.)
8. Turn off the incubator.

Gen5 System Test Report

Reader: Synergy HTX (Serial Number: EM-04)
 Basecode: P/N 1340200 (v1.00)
 Gen5 Version: 2.06.6
 Date and Time: 1/29/2014 11:19:29 AM
 User: Administrator
 Company:
 Comments:

Test Results

SYSTEM TEST PASS

Operator ID: _____

Notes: _____

SYSTEM SELF TEST				
1340200	Version 1.00	EM-04	SW1	S1
			1100	1000
			AF	T
Voltage Reference Test	Min	Low	High	Max
24V Power	1949			
Xenon Flash	1431	1741	2164	2473
Motor Power	2054			
Tungsten Lamp	12			1724

ABSORBANCE

Optics Test	Ref	Meas	Gain	Resets
#1:200			1.73	2
Light	13454	38437		
Dark	9874	9884		
Delta	3580	28553		
#2:352			1.46	4
Light	12848	39920		
Dark	9878	9885		
Delta	2970	30035		
#3:620			2.75	2
Light	12829	39979		
Dark	9870	9884		
Delta	2959	30095		
#4:790			2.10	2
Light	12976	39426		
Dark	9873	9883		
Delta	3103	29543		
#5:860			1.51	1
Light	13001	39198		
Dark	9871	9881		
Delta	3130	29317		
#6:962			1.88	1
Light	13099	39240		
Dark	9869	9879		
Delta	3230	29361		
Noise Test	Ref	Meas		
Max	9853	9901		
Min	9852	9900		
Delta	1	1		

FLUORESCENCE/LUMINESCENCE
 Filter PCB

Bias current offset	-0.4 counts	PASS
Offset voltage	1630 counts	PASS
750V measurement	21.2 counts	PASS
750V noise	10 counts	
750V offset	1633 counts	
500V measurement	3.5 counts	
500V noise	1 counts	
500V offset	1631 counts	
Reset offset	1653 counts	

Excitation Wheel

#1:360/40
 #2:485/20
 #3:PLUG
 #4:PLUG

Emission Wheel

#1:460/40
 #2:528/20
 #3:645/40
 #4:PLUG

CALIBRATION

Carrier - Bottom Fluorescence Probe

Upper Left	x= 9740	y= 1784
Lower Left	x= 9732	y= 7312
Lower Right	x= 1044	y= 7312
Upper Right	x= 1048	y= 1792
Delta 1	9740 - 9732=	+8
Delta 2	1048 - 1044=	+4
Delta 3	1792 - 1784=	+8
Delta 4	7312 - 7312=	+0

Carrier - Top Fluorescence Probe

Upper Left	x= 9744	y= 232
Lower Left	x= 9732	y= 5756
Lower Right	x= 1044	y= 5748
Upper Right	x= 1056	y= 224
Delta 1	9744 - 9732=	+12
Delta 2	1056 - 1044=	+12
Delta 3	224 - 232=	-8
Delta 4	5748 - 5756=	-8

Carrier - Absorbance Probe

Upper Left	x=11292	y= 1796
Lower Left	x=11284	y= 7316
Lower Right	x= 2592	y= 7316
Upper Right	x= 2604	y= 1796
Delta 1	11292 - 11284=	+8
Delta 2	2604 - 2592=	+12
Delta 3	1796 - 1796=	+0
Delta 4	7316 - 7316=	+0

Carrier - Injectors

Upper Left	x= 9744	y= 1388
Lower Left	x= 9732	y= 6912
Lower Right	x= 1044	y= 6904
Upper Right	x= 1056	y= 1380
Delta 1	9744 - 9732=	+12
Delta 2	1056 - 1044=	+12
Delta 3	1380 - 1388=	-8
Delta 4	6904 - 6912=	-8

Carrier - Test Sensors

Middle Sensor	y=11968
---------------	---------

```

Tested          11976
Delta           +8
Back Sensor     x=11600   y= 7896
Tested          11604   7892
Delta           +4      -4

Probe Height    33.74 mm
Monochromator   B=-0.000199 C=+0.254399

INCUBATION
Temperature Setpoint: 0.0      Current Average: 25.2      A/D Test: PASS
Zone 1: 25.3   Min: 25.3   Max: 25.3   Range: PASS   Thermistor: PASS
Zone 2: 24.8   Min: 24.8   Max: 24.8   Range: PASS   Thermistor: PASS
Zone 3: 25.4   Min: 25.4   Max: 25.4   Range: PASS   Thermistor: PASS
Zone 4: 25.3   Min: 25.3   Max: 25.3   Range: PASS   Thermistor: PASS

0000

Dispenser 1: 005.0,010.0,020.0,040.0,080.0,200.0
Dispenser 2: 005.0,010.0,020.0,040.0,080.0,200.0

Reviewed/Approved By: _____ Date: _____
Technical Support
In the U.S.:
  BioTek Instruments, Inc.
  Tel: 800 242 4685
  Fax: 802 654 0638

In Europe:
  BioTek Instruments GmbH
  Tel: 49(0)7136-9680
  Fax: 49(0)7136-968-111

All Others:
  Tel: 802 655 4040
  Fax: 802 654 0638

email: TAC@biotek.com
Product support center: www.biotek.com/service

```

Figure 1: Sample output for the system test

Absorbance Plate Test

Applies only to Synergy HTX models with absorbance capability.

This test uses BioTek's Absorbance Test Plate (PN 7260522) to confirm the mechanical alignment; optical density accuracy, linearity, and repeatability; and wavelength accuracy of the Synergy HTX. The Absorbance Plate Test compares the reader's optical density and wavelength measurements to NIST-traceable values.

❖ An alternate method that may be used to determine accuracy, linearity, and repeatability is Liquid Test 2, described on page 112.

Test Plate Certificates

To run this test, you will need BioTek's Absorbance Test Plate (PN 7260522), with its accompanying data sheet.

- The Absorbance OD Standards section contains NIST-traceable standard OD values for the filters at several different wavelengths. We recommend testing at six wavelengths – those at or close to the wavelengths used in your assays.
- The Wavelength Accuracy Standards section contains Expected Peak wavelength values for the filter in position C6 on the plate. Each value has a valid test range associated with it. For example, an Expected Peak value may be 586 nm with tolerance values of -6/+4 (or a test range of 580 to 590 nm).

❖ The instructions provided below and on the following page are guidelines. Refer to the Gen5 Help system for more information.

Define Absorbance Test Plate Parameters

❖ Before the Absorbance Plate Test can be performed, the standard OD values and the peak wavelength value(s) must be entered into Gen5. You'll enter and save these values once initially, and then update them each time the test plate is recertified by BioTek (typically annually).

1. Obtain the data sheet that came with the Test Plate.
2. Start Gen5 and select **System > Diagnostics > Test Plates > Add/Modify Plates**.
3. Click **Add**.
4. Select the appropriate Plate Type, and enter the plate's Serial Number.
5. Enter the Last Certification and Next Certification dates from the calibration sticker on the Test Plate.

6. If the wavelength values in the top row of the grid are appropriate for your tests, enter the OD values from the data sheet into the grid. Make sure you enter the correct value for each well/wavelength combination.
 - If you need to change the wavelength values, click **Wavelength List**. Click the Gen5 **Help** button for assistance.
7. Select the number of Peak Wavelength tests to run (1 to 4), based on the number of peak wavelength values provided on the data sheet.
8. Enter the Expected Peak value(s) from the data sheet. (If multiple values are given for a wavelength, use those in the 2.4 nm Spectral Bandpass table.) For each value, define the expected Test Range by selecting the minus/plus tolerance values. The range must span at least 8 nm.

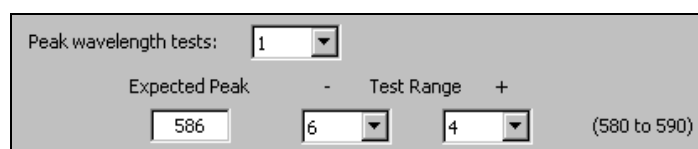

Peak wavelength tests: 1

Expected Peak: 586 - Test Range: 6 + 4 (580 to 590)

❖ For certificates that have only one peak wavelength and a fixed wavelength range of 580 to 590 nm, enter the Expected Peak wavelength value and adjust the Test Range values so the range displayed in parentheses is 580 to 590 (as demonstrated above).

9. Review all of the values you entered, and then click **OK** to save the data. The information you just entered will be available in Gen5 each time the Absorbance Plate Test is performed. It may need to be modified after the annual recertification of your test plate.

Run the Absorbance Plate Test

1. In Gen5, select **System > Diagnostics > Test Plates > Run**.
2. If prompted, select the desired **Test Plate** and click **OK**.
3. When the Absorbance Test Plate Options dialog appears, check **Perform Peak Wavelength Test** if it is not already checked.
4. Highlight the wavelength(s) to be included in this test.

❖ You need to select only those wavelengths most appropriate for your use of the reader.

5. (Optional) Enter any **Comments**.
6. Click **Start Test**.
7. Place the Test Plate in the microplate carrier so that well A1 is in the **left rear** corner of the carrier (as you are facing the carrier).
8. Click **OK** to run the test.

9. When the test completes, the results report will appear. Scroll down through the report; every result should show "PASS". See page 104 for information on results and troubleshooting tips in the event of failures.
 - A sample test report is shown on page 104.
 - Gen5 stores the results in a database; they can be retrieved and printed at any time. We recommend you print and save the report to document that the test was performed.

Absorbance Test Plate Results

Reader: Synergy HTX (Serial Number: EM-04)
 Basecode: P/N 1340200 (v1.00)
 Date and Time: 07/08/2012 03:03:36 PM
 Absorbance Plate: 7 Filter Test Plate (P/N 7260522) - S/N 161259
 Last Plate Certification: December 2013
 Next Plate Certification Due: December 2014
 User: Administrator
 Comments: Test performed during Initial OQ

Peak Absorbance Results

Well C6
 Reference 586
 Tolerance 3
 Read 587
 Result PASS

Alignment Results

Wells	A1	A12	H1	H12
Read	0.001	0.002	0.001	0.002
Tolerance	0.015	0.015	0.015	0.015
Result	PASS	PASS	PASS	PASS

Wavelength = 405 nm

Accuracy Results

Wells	C1	E2	G3	H6	F5	D4
Reference	0.147	0.618	1.133	1.701	2.279	2.945
Min Limit	0.124	0.586	1.090	1.647	2.168	2.807
Max Limit	0.170	0.650	1.176	1.755	2.390	3.083
Read 1	0.144	0.615	1.128	1.696	2.284	2.908
Result	PASS	PASS	PASS	PASS	PASS	PASS

Repeatability Results

Wells	C1	E2	G3	H6	F5	D4
Read 1	0.144	0.615	1.128	1.696	2.284	2.908
Min Limit	0.138	0.604	1.112	1.674	2.210	2.816
Max Limit	0.150	0.626	1.144	1.718	2.358	3.000
Read 2	0.144	0.615	1.128	1.695	2.285	2.903
Result	PASS	PASS	PASS	PASS	PASS	PASS

Wavelength = 630 nm

Accuracy Results

Wells	C1	E2	G3	H6	F5	D4
Reference	0.136	0.568	1.040	1.560	1.865	2.400
Min Limit	0.113	0.537	0.999	1.509	1.808	2.284
Max Limit	0.159	0.599	1.081	1.611	1.922	2.516
Read 1	0.134	0.566	1.037	1.557	1.866	2.385
Result	PASS	PASS	PASS	PASS	PASS	PASS

Repeatability Results						
Wells	C1	E2	G3	H6	F5	D4
Read 1	0.134	0.566	1.037	1.557	1.866	2.385
Min Limit	0.128	0.555	1.022	1.536	1.842	2.308
Max Limit	0.140	0.577	1.052	1.578	1.890	2.462
Read 2	0.135	0.566	1.037	1.558	1.867	2.385
Result	PASS	PASS	PASS	PASS	PASS	PASS
Reviewed/Approved By: _____						
Date: _____						
For Technical Support						
In the U.S.:			In Europe:			
BioTek Instruments, Inc.			BioTek Instruments GmbH			
Tel: 800 242 4685			Tel: 49 (0) 7136-9680			
Fax: 802 655 3399			Fax: 49 (0) 7136-968-111			
All Others:						
Tel: 802 655 4040						
Fax: 802 655 3399						
email: TAC@biotek.com						
Product support center: www.biotek.com/service						

Figure 2: Sample output for the Absorbance Plate Test

Results and Troubleshooting Tips

The Absorbance Test Plate Report contains results for the following:

- Peak Absorbance:** When the test is performed, the C6 filter is scanned at the test range(s) defined by the user in the Absorbance Test Plate dialog. To verify wavelength accuracy, the wavelength of the maximum absorbance is compared with the peak wavelength value entered in the software, which comes from the data sheet supplied with the Test Plate. The accuracy of the wavelength should be ± 3 nm (± 2 nm instrument, ± 1 nm filter allowance).

If the test fails:

- Check the C6 filter to make sure it is clean. If needed, clean it with lens paper. **Important!** Do not remove the filter from the Test Plate, and do not use alcohol or other cleaning agents.
- Make sure the information entered into Gen5 matches the information on the Test Plate's data sheet.
- Make sure the Test Plate is within its calibration certification period. The calibration sticker is affixed directly to the plate. If it is out of date, contact BioTek to schedule a recertification.
- Check the microplate carrier to ensure it is clear of debris.

- **Alignment:** This portion of the test measures the alignment of the microplate carrier with the optical path. A reading greater than 0.015 OD in the four corner holes represents an out-of-alignment condition.

If the test fails:

- Ensure that the Test Plate is correctly seated in the microplate carrier.
 - Check the four alignment holes (A1, A12, H1, H12) to ensure they are clear of debris.
 - Check the microplate carrier to ensure it is clear of debris.
 - If the problem continues to reoccur, contact BioTek TAC.
- **Accuracy:** Accuracy is a measure of the optical density of the neutral-density filters in wells C1, D4, E2, F5, G3, and H6 as compared with known standard values contained in the test plate's data sheet.

Since there are several filters with differing OD values, the accuracy across a range of ODs can be established. Once it is proven that the reader is accurate at these OD values, the reader is also considered linear. To further verify this, you can perform a regression analysis on the Test Plate OD values in a program such as Microsoft Excel. An R Square value of at least 0.990 is expected.

If the test fails:

- Check the filters in the Test Plate to ensure they are clean. If necessary, clean them with lens paper. Do not remove the filters from the test plate, and do not use alcohol or other cleaning agents.
 - Verify that the filter calibration values entered in Gen5 are the same as those on the Test Plate's data sheet.
 - Verify that the Test Plate is within its calibration certification period. The calibration sticker is affixed directly to the plate. If it is out of date, contact BioTek to schedule a recertification.
- **Repeatability:** Repeatability is a measure of the instrument's ability to read the same well with minimum variation between two reads with the well in the same location.

If the test fails:

- Check the neutral-density filters on the Test Plate to ensure there is no debris that may have shifted between readings and caused changes.
- Check the microplate carrier to ensure it is clear of debris.

Luminescence Tests

For Synergy HTX models with luminescence capability, you can use a Harta Luminometer Reference Microplate, which is an LED-based test plate. Contact BioTek to purchase a plate, or go to www.hartainstruments.com for more information.

Harta Plate Test

Materials

- Harta Luminometer Reference Microplate, PN 8030015
- Harta plate adapter, PN 8032028
- Gen5 protocol (see page 107)

Procedure

1. Turn on the Harta reference plate using the I/O switch on the back of the plate.
2. Check the plate's battery by pressing the test button on the back of the plate and ensuring that the test light turns on.

❖ The test light may be difficult to see in bright light. Change your angle of view or move to a darker environment if you cannot see it.

3. Place the Harta plate adapter on the reader's carrier and then place the test plate on top of the adapter.
4. Create an experiment based on **Synergy HTX LumTest_Harta.prt** protocol, and read the plate.
5. Calculate and evaluate results as described under **Results Analysis** below.

Plate Layout

	1	2	3	4	5	6	7	8	9	10	11	12
A		A2 meas					battery check	battery check				
B												
C												
D												
E												
F	buffer	buffer	buffer	buffer	buffer	buffer	buffer	buffer	buffer	buffer	buffer	buffer
G	buffer	buffer	buffer	buffer	buffer	buffer	buffer	buffer	buffer	buffer	buffer	buffer
H												

Results Analysis

❖ Through a manual correlation process, it was found that the system requires approximately 35 photons per attomole of ATP, thus a conversion factor of 0.02884 attomole/photon was applied to determine ATP concentration from the NIST data in photons/s.

1. On the Harta plate's Calibration Certificate, locate the NIST measurement for the A2 position and convert to attomoles:
(A2 NIST measurement * 0.02884)
2. Determine if the plate's battery is still functioning properly:
 - If $A8 > A7$, the battery is good.
 - If $A8 < A7$, the battery requires replacement.

❖ A replacement battery is included with each Harta plate. A new spare battery will be supplied when the plate is recertified.

3. Calculate the signal-to-noise ratio:
(A2 - Mean of the buffer cells)/(3 * Standard deviation of buffer cells)
4. Calculate the detection limit:
A2 NIST measurement in attomoles/signal-to-noise ratio
 - If the reader is equipped with the low-noise PMT, the detection limit must be **≤ 60 amol** to pass.
 - If the reader is equipped with the red-shifted PMT, the detection limit must be **≤ 500 amol** to pass.

❖ To determine which PMT is installed, check the label on the back of the reader. #49984 = low-noise PMT; #49721 = red-shifted PMT

Gen5 Protocol Reading Parameters

The information in the following tables represents the recommended reading parameters.

Synergy HTX LumTest_Harta.prt

Parameter	Default Setting
Plate Type:	Harta plate (8030015) with adapter (8032028)
Delay Step:	3 minutes
Read Step 1:	
Read Wells:	A2
Label:	Reference well A2
Detection Method:	Luminescence
Read Type:	Endpoint

Integration Time:	0:10.00 MM:SS.ss
Delay After Plate Movement:	100 msec
Dynamic Range:	Standard
Filter Sets	1
Excitation	Plug
Emission:	Hole
Optics Position:	Top
Gain/Sensitivity:	150
Read Height:	1.00 mm
Read Step 2:	
Read Wells:	F1–G12
Label:	Background
Detection Method:	Luminescence
Read Type:	Endpoint
Integration Time:	0:10.00 MM:SS.ss
Delay After Plate Movement:	100 msec
Dynamic Range:	Standard
Filter Sets	1
Excitation	Plug
Emission:	Hole
Optics Position:	Top
Gain/Sensitivity:	150
Read Height:	1.00 mm
Read Step 3:	
Read Wells:	A7–A8
Label:	Battery Check
Detection Method:	Luminescence
Read Type:	Endpoint
Integration Time:	0:01.00 MM:SS.ss
Delay After Plate Movement:	100 msec
Dynamic Range:	Standard
Filter Sets	1
Excitation	Plug

Emission:	Hole
Optics Position:	Top
Gain/Sensitivity:	50
Read Height:	1.00 mm

Troubleshooting

If either test fails, try the following suggestions. If the test(s) continues to fail, print the results and contact BioTek's Technical Assistance Center.

- Ensure that the reading is performed through a hole in the filter wheel, not through a glass filter.
- Verify that the filter settings in Gen5 match the physical wheel.
- If the test continues to fail, the optical probe(s) **may** need to be cleaned. Contact BioTek's Technical Assistance Center for instructions.

Absorbance Liquid Tests

Conducting Liquid Tests confirms the Synergy HTX's ability to perform to specification with liquid samples. Liquid testing differs from testing with the Absorbance Test Plate in that liquid in the wells has a meniscus, whereas the Test Plate's neutral density glass filters do not. The optics characteristics may differ in these two cases, thus alerting the operator to different types of problems.

- **Liquid Test 1** confirms repeatability and alignment of the reader when a solution is used in the microplate. If these tests pass, then the lens placement and optical system cleanliness are proven.
- **Liquid Test 2** can be used to test the alignment, repeatability, and linearity of the reader if an Absorbance Test Plate is not available.
- **Liquid Test 3** is provided for sites requiring proof of linearity at wavelengths lower than those attainable with the Absorbance Test Plate. This test is optional because the reader has good "front end" linearity throughout its wavelength range.

For Liquid Tests 1 and 2, instructions are given to prepare the stock dye solution described on the next page. The purpose of the formulation is to create a solution that absorbs light at ~2.0 OD full strength when dispensed at 200 μ L in a flat-bottom microplate well.

Alternatively, any solution that gives a stable color will suffice. (This includes substrates incubated with an enzyme preparation and then stopped with an acidic or basic solution.) Some enzyme/substrate combinations that may be used as alternates to the described dye are shown below:

Typical Enzyme-Substrate Combinations and Stopping Solutions

Enzyme	Substrate	Stopping Solution
Alkaline Phosphate	o-nitrophenyl phosphate	3N sodium hydroxide
beta-Galactosidase	o-nitrophenyl -beta-D galactopyranoside	1M sodium carbonate
Peroxidase	2,2'-Azino di-ethylbenzothiazoline-sulfonic acid (ABTS)	citrate-phosphate buffer, pH 2.8
Peroxidase	o-phenylenediamine	0.03N sulfuric acid

Absorbance Liquid Test 1**Materials**

❖ Manufacturer part numbers are subject to change.

- New 96-well, clear, flat-bottom microplate (Corning Costar #3590 recommended)
- Stock Solution A or B, which may be formulated by diluting a dye solution available from BioTek (A) or from the ingredients listed below (B).

Solution A

- BioTek QC Check Solution No. 1 (PN 7120779, 25 mL; PN 7120782, 125 mL)
 - Deionized water
 - 5-mL Class A volumetric pipette
 - 100-mL volumetric flask
1. Pipette a 5-mL aliquot of BioTek QC Check Solution No. 1 into a 100-mL volumetric flask.
 2. Add 95 mL of DI water; cap and shake well. The solution should measure approximately 2.000 OD when using 200 μ L in a flat-bottom microwell.

Solution B

- Deionized water
- FD&C Yellow No. 5 dye powder (typically 90% pure)
- Tween 20 (polyoxyethylene (20) sorbitan monolaurate) **or** BioTek wetting agent (PN 7773002) (a 10% Tween solution)
- Precision balance with capacity of 100 g minimum and readability of 0.001 g
- Weigh boat
- 1-liter volumetric flask

1. Weigh out 0.092 g of FD&C Yellow No. 5 dye powder into a weigh boat.
2. Rinse the contents into a 1-liter volumetric flask.
3. Add 0.5 mL of Tween 20, or 5 mL of BioTek's wetting agent.
4. Fill to 1 liter with DI water; cap and shake well. The solution should measure approximately 2.000 OD when using 200 μ L in a flat-bottom microwell.

Prepare the Plate

❖ Be sure to use a new microplate, because fingerprints or scratches may cause variations in readings.

1. Using freshly prepared stock solution (Solution A or B), prepare a 1:2 dilution using deionized water (one part stock, one part deionized water; the resulting solution is a 1:2 dilution).
2. Pipette 200 μ L of the concentrated solution (A or B) into the first column of wells in the microplate.
3. Pipette 200 μ L of the diluted solution into the second column of wells.

❖ After pipetting the diluted test solution into the microplate and before reading the plate, we strongly recommend shaking the plate for four minutes. This will allow any air bubbles in the solution to settle and the meniscus to stabilize. Alternatively, wait 20 minutes after pipetting the test solution before reading the plate.

Read the Plate

1. Using Gen5, read the microplate **five times** at 405 nm using the Normal read mode, single wavelength, no blanking. Save the data after each read ("Normal" plate position).
2. Without delay, rotate the microplate 180 degrees so that well A1 is in the "H12" position. Read the plate **five more times**, saving the data after each read ("Turnaround" plate position).
3. Print out the ten sets of raw data, or export them to an Excel spreadsheet.

Analyze the Results

1. Calculate the mean value for each physical well location in columns 1 and 2 for the five plates read in the Normal position, and then again for the five plates read in the Turnaround position. This will result in 32 mean values.
2. Perform a mathematical comparison of the mean values for each microwell in its Normal and Turnaround positions (that is, compare A1 to H12, A2 to H11, B1 to G12, ... H2 to A11). To pass this test, the differences in the

compared mean values must be within the accuracy specification for the instrument.

Example: If the mean value for well A1 in the Normal position is 1.902 with a specified accuracy of $\pm 1.0\% \pm 0.010$ OD, then the expected range for the mean of the same well in its Turnaround (H12) position is 1.873 to 1.931 OD.

$$1.902 \times 0.010 + 0.010 = 0.029; 1.902 - 0.029 = \mathbf{1.873}; 1.902 + 0.029 = \mathbf{1.931}$$

- **Accuracy Specification.** The following accuracy specifications are applied using Normal mode and a 96-well microplate:

$\pm 1.0\% \pm 0.010$ OD from 0.000 to 2.000 OD

$\pm 3.0\% \pm 0.010$ OD from 2.000 OD to 3.000 OD

Absorbance Liquid Test 2

Materials

- A new 96-well, clear, flat-bottom microplate, such as Corning Costar #3590
- Ten test tubes, numbered consecutively, set up in a rack
- Calibrated hand pipette (Class A volumetric pipette recommended)
- Stock solution A or B (see page 110)
- A 0.05% solution of deionized water and Tween 20

Prepare the Dilutions

Create a percentage dilution series, beginning with 100% of the original concentrated stock solution (A or B) in the first tube, 90% of the original solution in the second tube, 80% in the third tube, all the way to 10% in the tenth tube. Dilute using the 0.05% solution of deionized water and Tween 20. This solution can also be made by diluting the BioTek wetting agent 200:1.

Test Tube Dilutions

Tube Number:	1	2	3	4	5	6	7	8	9	10
Volume of Original Concentrated Solution (mL)	20	18	16	14	12	10	8	6	4	2
Volume of 0.05% Tween Solution (mL)	0	2	4	6	8	10	12	14	16	18
Absorbance expected if original solution is 2.0 at 200 μ L	2.0	1.8	1.6	1.4	1.2	1.0	0.8	0.6	0.4	0.2

❖ The choice of dilutions and the absorbance of the original solution can be varied. Use this table as a model for calculating the expected absorbances of a series of dilutions, given a different absorbance of the original solution.

Prepare the Plate

- Pipette 200 μ L of the concentrated solution from Tube 1 into each well of the first column, A1 to H1, of a new flat-bottom microplate.
- Pipette 200 μ L from each of the remaining tubes into the wells of the corresponding column of the microplate (Tube 2 into wells A2 to H2, Tube 3 into wells A3 to H3, and so on).

Linearity and Repeatability Tests

1. Using Gen5, read the microplate prepared above **five times** using Normal mode, dual wavelength at 450/630 nm. Save the data after each read.

❖ Do not discard the plate; you will use it for the Alignment test.

2. Print out the five sets of **Delta OD** data, or export them to an Excel spreadsheet.
3. Calculate the results for Linearity:
 - Calculate the mean absorbance for each well, and average the means for each concentration.
 - Perform a regression analysis on the data to determine if there is adequate linearity.

Since it is somewhat difficult to achieve high pipetting accuracy when conducting linear dilutions, an R Square value of at least 0.99 is considered adequate.

4. Calculate the results for Repeatability:
 - Calculate the mean and standard deviation for the five readings taken in Step 1 at each concentration. Only one row of data needs to be analyzed.
 - For each mean below 2.000 OD, calculate the allowed deviation using the repeatability specification for a 96-well plate of $\pm 1.0\% \pm 0.005$ OD. If above 2.000 OD, apply the $\pm 3.0\% \pm 0.005$ specification.
 - The standard deviation for each set of readings should be less than the allowed deviation.

Example: Absorbance readings of 1.950, 1.948, 1.955, 1.952, and 1.950 will result in a mean of 1.951, and a standard deviation of 0.0026. The mean (1.951) multiplied by 1.0% (1.951×0.010) = 0.0195, which, when added to the 0.005 ($0.0195 + 0.005$) = 0.0245 OD, which is the allowable deviation. Since the standard deviation is less than this value, the reader meets the test criteria.

Repeatability Specification:

$\pm 1.0\% \pm 0.005$ OD from 0.000 to 2.000 OD

$\pm 3.0\% \pm 0.005$ OD from 2.000 OD to 3.000 OD

Alignment Test

1. Using the plate prepared for the Linearity Test on the previous page, conduct a Turnaround test by reading the plate **five times** with the A1 well in the H12 position. Save the data after each read.

This test results in values for the four corner wells that can be used to determine alignment.

2. Calculate the means of the wells A1 and H1 in the Normal plate position (data from Linearity Test) and in the Turnaround position (from Step 1 above).
3. Compare the mean reading for well A1 to its mean reading when in the H12 position. Next, compare the mean values for the H1 well to the same well in the A12 position. The difference in the values for any two corresponding wells should be within the accuracy specification for the instrument.

Example: If the mean of well A1 in the normal position is 1.902, where the specified accuracy is $\pm 1.0\% \pm 0.010$ OD, then the expected range for the mean of the same well in the H12 position is 1.873 to 1.931 OD. ($1.902 \times 1.0\% = 0.019 + 0.010 = 0.029$, which is added and subtracted from 1.902 for the range.)

If the four corner wells are within the accuracy range, the reader is in alignment.

Absorbance Liquid Test 3 (optional)

Materials

- New 96-well, clear, flat-bottom microplate (Corning Costar #3590 is recommended)
- Calibrated hand-pipette(s)
- Beakers and graduated cylinder
- Precision balance with readability to 0.01 g
- Buffer Solution described below

- ❖ Read a sample of the buffer solution at 340 nm. This solution should have an optical density of approximately 0.700 to 1.000. This value is not critical, but it should be within this range.
- ❖ If low, adjust up by adding β -NADH powder until the solution is at least at the lower end of this range. Do not adjust if slightly high.

Buffer Solution

- Deionized water
- Phosphate-Buffered Saline (PBS), pH 7.2–7.6, Sigma tablets, #P4417 (or equivalent)
- β -NADH Powder (β -Nicotinamide Adenine Dinucleotide, Reduced Form) Sigma bulk catalog number N 8129, or preweighed 10-mg vials, Sigma number N6785-10VL (or BioTek PN 98233). **Note:** Manufacturer part numbers are subject to change.

❖ Store the β -NADH Powder according to the guidelines on its packaging.

1. Prepare a PBS solution from the Sigma tablets.
2. In a beaker, mix 50 mL of the PBS solution with 10 mg of the β -NADH powder and mix thoroughly. This is the **100% Test Solution**.

Prepare the Plate

1. Prepare a **75% Test Solution** by mixing 15 mL of the 100% Test Solution with 5 mL of the PBS solution.
2. Prepare a **50% Test Solution** by mixing 10 mL of the 100% Test Solution with 10 mL of the PBS solution.
3. Pipette the three solutions into a **new** 96-well microplate:
 - 150 μ L of the 100% Test Solution into all wells of columns 1 and 2
 - 150 μ L of the 75% Test Solution into all wells of columns 3 and 4
 - 150 μ L of the 50% Test Solution into all wells of column 5 and 6

Read the Plate

1. Using Gen5, read the microplate five times using Normal mode, single wavelength at 340 nm, no blanking. Save the data after each read.
2. Print out the five sets of raw data, or export them to an Excel spreadsheet.

Analyze the Results

1. For each well, calculate the mean and standard deviation of the five readings.
2. For each mean calculated in step 1, calculate the allowed deviation using the repeatability specification for a 96-well plate of $\pm 1.0\% \pm 0.005$ OD (Mean $\times 0.010 \pm 0.005$). For each well, its standard deviation should be less than its allowed deviation.

Example: Five readings in well A1 of 0.802, 0.802, 0.799, 0.798, and 0.801 will result in a mean of 0.8004 and a standard deviation of 0.0018. The mean

multiplied by 1.0% ($0.8004 * 0.010$) equals 0.008, and when added to the 0.005 ($0.008 + 0.005$) equals **0.013**, which is the allowed deviation for well A1. Since the standard deviation for well A1 is less than 0.013, the well meets the test criteria.

- **Repeatability Specification:**

- ± 1.0% ± 0.005 OD from 0.000 to 2.000 OD

- ± 3.0% ± 0.005 OD from 2.000 OD to 3.000 OD

3. Calculate the results for Linearity:

- For each of the three Test Solutions, calculate the mean absorbance for the wells containing that solution (mean of wells A1 to H2, A3 to H4, and A5 to H6).
- Perform a regression analysis on the data to determine if there is adequate linearity on a program such as Microsoft Excel:

Since it is somewhat difficult to achieve high pipetting accuracy when conducting linear dilutions, an **R Square** value of at least 0.99 is considered adequate.

Fluorescence Tests

- The **Corners Test** uses fluorescent compounds to verify that the plate carrier is properly aligned in relation to the fluorescence probe(s). We recommend running the test for both the top and bottom probes.
- The **Sensitivity Test** uses a fluorescent compound and buffer solution to test the fluorescence reading capability of the instrument. The ability to detect specific compounds at the required limit of detection ensures that the filters, optical path, and PMT are all in working order. This test verifies that the difference between the concentration well under investigation and the mean of the median buffer well is statistically distinguishable.
- The **Linearity Test** verifies that the system is linear, that is, signal changes proportionally with changes in concentration. Proving that the system is linear allows the Sensitivity Test to be run on two points instead of using serial dilutions.



Important! The tests presented in this section require specific microplates, solutions, and EX/EM filters. Your laboratory may require a deviation from some of these tests. For example, you may wish to use a different fluorescing solution and/or microplate.

If deviation from the tests as presented in this section is required, the following steps should be taken the first time each test is run (e.g., during the **Initial OQ**):

1. Perform the tests exactly as described on the following pages.
2. Rerun the tests using your particular solutions, filters, microplates, etc. If results are comparable, then the results from these tests will be your baseline for future tests.
3. Be sure to document your new test procedure(s), and save all test results.

Required Materials

- ❖ BioTek offers a liquid test kit (PN 7160013) containing the microplates and solutions used in this procedure.
- ❖ Microplates should be perfectly clean and free of dust or bottom scratches. Use new microplates from sealed packages.
- ❖ Manufacturer part numbers are subject to change.
- ❖ Methylumbelliferone can be used as an alternative or supplemental method for performing these tests for the top probe. See the instructions starting on page 123.

- Buffer:
 - NIST-traceable Sodium Borate Reference Standard (pH 9.18) (e.g., Fisher-Scientific 1 L Sodium Borate Mfr. #159532, or equivalent), **or**
 - Phosphate-Buffered Saline (PBS), pH 7.2-7.6 (e.g., Sigma tablets, Mfr. #P4417, or equivalent) and pH meter or pH indicator strips with pH range 4 to 10
- Sodium Fluorescein Powder (1 mg vial, BioTek PN 98155)
- Bottom optics: A clean Hellma Quartz 96-well titration plate (Mfr. #730.009.QG), or equivalent, such as the 96-well glass-bottom Greiner SensoPlate (Mfr. #655892).
- Top optics: A new, clean, 96-well solid black microplate, such as Corning Costar Mfr. #3915. The Hellma Quartz plate described above can also be used.

- Excitation filter 485/20 nm and Emission filter 528/20 nm, installed
- Deionized or distilled water
- Various beakers, graduated cylinders, and pipettes
- pH meter or pH indicator strips with pH range 4 to 10
- 95% Ethanol (for cleaning the bottoms of the plates)
- Aluminum foil
- (Optional, but recommended) 0.45 micron filter
- (Optional) Black polyethylene bag(s) to temporarily store plate(s)
- **Synergy HTX FI_B.prt** and **Synergy HTX FI_T.prt** protocols described on page 122.

Test Solutions



If using BioTek's sodium fluorescein powder (PN 98155), be sure to hold the vial upright and open it carefully; the material may be concentrated at the top. If a centrifuge is available, spin down the tube before opening.

When diluting the sodium fluorescein powder in buffer, it takes time for the powder to completely dissolve. Allow the solution to dissolve for five minutes, with intermittent vortexing, before preparing the titration dyes.

Wrap the vial containing the SF stock solution in foil to prevent exposure to light.

Discard any open, unused solutions after seven days.

1. The Sodium Borate solution does not require further preparation; proceed to step 2. If you are using PBS, prepare the solution now:
 - (Optional, but recommended) Using a 0.45-micron filter, filter 200 mL of deionized or distilled water.
 - Follow the manufacturer's instructions on the PBS packaging to create 200 mL, dissolving the necessary amount of PBS into the filtered water.
 - Stir the solution (preferably using a stir table) until the PBS is completely dissolved.
 - Check the pH; it should be between 7.2 and 7.6 at 25°C (77°F).
2. Prepare the sodium fluorescein stock solution:
 - Add 2.0 mL of the PBS solution to the 1 mg Sodium Fluorescein (SF) vial. This yields a **1.3288 mM stock solution**.
 - Ensure that the dye has completely dissolved and is well mixed.

- Carefully prepare the dilutions. Label each with "SF" and the concentration:

Mix this SF solution:	with buffer:	to make:	
0.53 mL of 1.3288 mM stock solution	13.47 mL	50.2 μ M	
110 μ L of 50.2 μ M solution	13.89 mL	400 nM	
3.5 mL of 400 nM solution	10.5 mL	100 nM	
0.46 mL of 100 nM solution	13.54 mL	3.3 nM	<i>Corners Test</i>
4.24 mL of 3.3 nM solution	9.76 mL	1 nM	<i>Sensitivity and Linearity Tests</i>

Procedure

- Create the Gen5 protocols (see page 122).
- If you have not already done so, prepare the test solutions (see page 118).
- Perform the tests using the **Bottom** optics:
 - Pipette the test solutions into a clean 96-well quartz or glass-bottom microplate (see the map on page 121).
 - Create an experiment based on the **Synergy HTX FI_B.prt** protocol and read the plate.
 - When complete, save the experiment using a unique name.
- Perform the tests using the **Top** optics:
 - Pipette the test solutions into a new 96-well solid black or quartz microplate (see the map on page 121).
 - Create an experiment based on the **Synergy HTX FI_T.prt** protocol and read the plate.
 - When complete, save the experiment using a unique name.
- Calculate and analyze the results as described below.

Results Analysis

Corners Test

- Calculate the Mean of the twelve wells containing the **3.3 nM** SF test solution (A1-A3, A10-A12, H1-H3, H10-H12).
- Calculate the Standard Deviation of the same twelve wells.
- Calculate the % CV: (Standard Deviation/Mean) * 100
The % CV must be **less than 3.0** to pass.

Sensitivity Test

1. Calculate the Mean and Standard Deviation of the 16 reads for each of the buffer wells (C9, D9, E9).
2. Among the three buffer wells, find the Median Standard Deviation and corresponding Mean.
3. Calculate the Mean for the 16 reads of the SF Concentration well (D7).
4. Calculate the Signal-to-Noise Ratio (SNR) using the Mean SF Concentration and the Buffer Media STD with its corresponding Buffer Mean:
(Mean SF – Buffer Mean)/(3 * Buffer STD)
5. Calculate the Detection Limit, in pM, using the known concentration value of SF and the calculated SNR: 1000/SNR

Optic Probe	Detection Limit must be less than or equal to:
Bottom 5 mm	30 pM (10 pg/mL)
Top 3 mm	53 pM (20 pg/mL)

Linearity Test

1. Calculate the Mean of the four wells for each concentration in columns 1–5.
2. Perform linear regression using these values as inputs:

x	y
1000	Mean of the 1000 pM wells
500	Mean of the 500 pM wells
250	Mean of the 250 pM wells
125	Mean of the 125 pM wells
62.5	Mean of the 62.5 pM wells

3. Calculate the R-Square value; it must be ≥ 0.9500 to pass.

Troubleshooting

If any tests fail, please try the suggestions below. If the test(s) continue to fail, print the results and contact BioTek's Technical Assistance Center.

- Are the solutions fresh? The open buffer and stock solutions should be discarded after seven days.
- Are the excitation/emission filters clean? Are they in the proper locations and in the proper orientation in the filter wheels?

- Are you using new/clean plates? We suggest you rerun the test with a new/clean microplate. For the bottom optics test, if the base of a plate is touched, clean the entire base with alcohol (95% ethanol) and then wipe with a lint-free cloth. Before placing a plate in the instrument, blow the bottom of the plate with an aerosol. If the test fails again, the optical probe(s) may need to be cleaned. Contact BioTek TAC for instructions.
- If the Corners Test continues to fail, the hardware may be misaligned. Contact BioTek TAC.
- Review the instructions under “Pipette Map” (page 121 for SF or 128 for MUB) to verify that you correctly prepared the plates.
- Does the Plate Type setting in the protocol match the plate you used?

Pipette Map

❖ Seal the plates with foil or store them in black polyethylene bags until use. If the base of a plate is touched, clean the entire base with alcohol (95% ethanol) and then wipe with a lint-free cloth. Before placing a plate in the instrument, blow the bottom of the plate with an aerosol duster.

Perform these steps carefully and refer to the grid on the next page.

For the **Corners** test (light gray wells):

- Pipette 200 μ L of the **3.3 nM SF** solution into wells A1-A3, A10-A12, H1-H3, and H10-H12.
- *If using a Hellma plate:* Pipette 200 μ L of buffer into the wells surrounding the 3.3 nM wells (“*CBUF*” in the grid).

For the **Sensitivity** test (dark gray wells):

- Pipette 200 μ L of the 1 nM SF solution into well D7.
- Pipette 200 μ L of the buffer solution into wells C9, D9, and E9.

For the **Linearity** test (wells C1–F5):

- Use a multichannel pipette with just four tips installed.
- Pipette 150 μ L of buffer solution into wells C2-F5. Discard the tips.
- Pipette 150 μ L of the **1 nM SF** solution into wells C1-F1.
- Pipette 150 μ L of the 1 nM SF solution into wells C2-F2. Mix the wells using the pipette. Do not discard the tips.
- Aspirate 150 μ L from wells C2-F2 and dispense into wells C3-F3. Mix the wells using the pipette. Do not discard the tips.
- Aspirate 150 μ L from wells C3-F3 and dispense into wells C4-F4. Mix the wells using the pipette. Do not discard the tips.

- Aspirate 150 μ L from wells C4-F4 and dispense into wells C5-F5. Mix the wells using the pipette.
- Aspirate 150 μ L from wells C5-F5 and discard.

	1	2	3	4	5	6	7	8	9	10	11	12
A	3.3 nM	3.3 nM	3.3 nM	CBUF					CBUF	3.3 nM	3.3 nM	3.3 nM
B	CBUF*	CBUF	CBUF	CBUF					CBUF	CBUF	CBUF	CBUF
C	150 μ L: 1.0 nM	0.5 nM	0.25 nM	0.125 nM	0.0625 nM				BUF			
D	1.0 nM	0.5 nM	0.25 nM	0.125 nM	0.0625 nM		200 μ L: 1.0 nM		BUF			
E	1.0 nM	0.5 nM	0.25 nM	0.125 nM	0.0625 nM				BUF			
F	1.0 nM	0.5 nM	0.25 nM	0.125 nM	0.0625 nM							
G	CBUF	CBUF	CBUF	CBUF					CBUF	CBUF	CBUF	CBUF
H	3.3 nM	3.3 nM	3.3 nM	CBUF					CBUF	3.3 nM	3.3 nM	3.3 nM

CBUF applies only to the Hellma Quartz plate.

Gen5 Protocol Reading Parameters

The following tables contain the recommended settings for the Gen5 protocols. Your tests may require modifications to some of these parameters, such as Plate Type or Gain (see “Troubleshooting” on page 120).

- ❖ Adjust the **Plate Type** setting to match the plate you are actually using, if different from shown here.

Protocol Name: Synergy HTX FI_B.prt	
Parameter	Default Setting
Plate Type:	Greiner SensoPlate (Mfr. #655892)
Read Step 1	
Kinetic Loop:	Run time :45 seconds Interval: 3 seconds Reads: 16
Read Step Label:	"Sensitivity Read"
Read Well:	D7
Filter Set:	EX 485/20 nm EM 528/20 nm
Optics Position:	Bottom
Gain:	Auto Scale to High Wells Scale Well: D7 Scale Value: 30000
Delay after Plate Movement:	100 msec
Measurements per Data Point:	50
Dynamic Range:	Standard
Light Source:	Tungsten
Read Step 2	
Kinetic Loop:	Run time: 1 minute, 35 seconds Interval: 6 seconds Reads: 16
Read Step Label:	"Sensitivity Read Buffer"
Read Wells:	C9-E9
Filter Set:	EX 485/20 nm EM 528/20 nm
Optics Position:	Bottom
Gain:	Auto Use first filter set gain from FIRST Read Step
Delay after Plate Movement:	100 msec
Measurements per Data Point:	50
Dynamic Range:	Standard
Light Source:	Tungsten
Read Step 3	
Read Step Label:	"Corners Read"

Protocol Name: Synergy HTX FI_B.prt	
Parameter	Default Setting
Read Wells:	A1–A3, A10–A12, H1–H3, H10–H12
Filter Set:	EX 485/20 nm EM 528/20 nm
Optics Position:	Bottom
Gain:	Auto Scale to High Wells Scale Well: A3 Scale Value: 30000
Delay after Plate Movement:	100 msec
Measurements per Data Point:	50
Dynamic Range:	Standard
Light Source:	Tungsten
Read Step 4	
Read Step Label:	“Linearity Read”
Read Wells:	C1–F5
Filter Set:	EX 485/20 nm EM 528/20 nm
Optics Position:	Bottom
Gain:	Auto Scale to High Wells Scale Well: C1 Scale Value: 30000
Delay after Plate Movement:	100 msec
Measurements per Data Point:	50
Dynamic Range:	Standard
Light Source:	Tungsten

Protocol Name: Synergy HTX FI_T.prt	
Parameter	Default Setting
Plate Type:	Costar 96 black opaque, Mfr. #3915
Read Step 1	
Kinetic Loop:	Run time :45 seconds Interval: 3 seconds Reads: 16
Read Step Label:	“Sensitivity Read”

Protocol Name: Synergy HTX FI_T.prt	
Parameter	Default Setting
Read Well:	D7
Filter Set:	EX 485/20 nm EM 528/20 nm
Optics Position:	Top
Gain:	Auto Scale to High Wells Scale Well: D7 Scale Value: 30000
Delay after Plate Movement:	100 msec
Measurements per Data Point:	50
Dynamic Range:	Standard
Light Source:	Tungsten
Read Height:	1.00 mm
Read Step 2	
Kinetic Loop:	Run time: 1 minute, 35 seconds Interval: 6 seconds Reads: 16
Read Step Label:	"Sensitivity Read Buffer"
Read Wells:	C9-E9
Filter Set:	EX 485/20 nm EM 528/20 nm
Optics Position:	Top
Gain:	Auto Use first filter set gain from FIRST Read Step
Delay after Plate Movement:	100 msec
Measurements per Data Point:	50
Dynamic Range:	Standard
Light Source:	Tungsten
Read Height:	1.00 mm
Read Step 3	
Read Step Label:	"Corners Read"
Read Wells:	A1-A3, A10-A12, H1-H3, H10-H12
Filter Set:	EX 485/20 nm EM 528/20 nm

Protocol Name: Synergy HTX FI_T.prt	
Parameter	Default Setting
Optics Position:	Top
Gain:	Auto Scale to High Wells Scale Well: A3 Scale Value: 30000
Delay after Plate Movement:	100 msec
Measurements per Data Point:	50
Dynamic Range:	Standard
Light Source:	Tungsten
Read Height:	1.00 mm
Read Step 4	
Read Step Label:	"Linearity Read"
Read Wells:	C1-F5
Filter Set:	EX 485/20 nm EM 528/20 nm
Optics Position:	Top
Gain:	Auto Scale to High Wells Scale Well: C1 Scale Value: 30000
Delay after Plate Movement:	100 msec
Measurements per Data Point:	50
Dynamic Range:	Standard
Light Source:	Tungsten

Fluorescence Tests Using Methylumbelliferone

As an alternative to using Sodium Fluorescein, Methylumbelliferone ("MUB") can be used to test the **top optics** for the fluorescence system.

Required Materials

- ❖ BioTek offers a liquid test kit (PN 7160012) containing the microplate and solutions used in this procedure.
- ❖ Microplates should be perfectly clean and free of dust or bottom scratches. Use new microplates from sealed packages.
- ❖ Manufacturer part numbers are subject to change.

- Methylumbelliferone (“MUB”) (10-mg vial, BioTek PN 98156)
- Carbonate-Bicarbonate buffer (“CBB”) capsules (BioTek PN 98158)
- 100% methanol (BioTek PN 98161)
- A new, clean, 96-well solid black plate, such as Corning Costar Mfr. #3915 or equivalent.
- Excitation filter 360/40 nm installed
- Emission filter 460/40 nm installed
- Deionized or distilled water
- Various beakers, graduated cylinders, and pipettes
- Aluminum foil
- (Optional, but recommended) 0.45 micron filter
- **Synergy HTX FI_MUB.prt** protocol described on page 129.

Test Solutions

1. Prepare the buffer (CBB) solution:
 - (Optional, but recommended) Using a 0.45-micron filter, filter 200 mL of deionized or distilled water.
 - Open and dissolve the contents of two CBB capsules (do not dissolve the outer gelatin capsule) into 200 mL of the water.
 - Stir the solution (preferably using a stir table) until the CBB is completely dissolved.
2. Prepare the MUB stock solution:
 - Add 1 mL of 100% methanol to the 10 mg vial of MUB.
 - Make sure all of the dye has completely dissolved and is well mixed. This yields a **10 mg/mL** stock solution.
 - Wrap the solution in aluminum foil to prevent exposure to light.
3. Prepare the dilutions. Label each with “MUB” and the concentration.

Mix this MUB solution:	with:	to make:
0.5 mL of 10 mg/mL stock solution	4.5 mL of 100% methanol	1 mg/mL
0.88 mL of 1 mg/mL solution	4.12 mL of CBB	176 µg/mL
0.1 mL of 176 µg/mL solution	9.9 mL of CBB	1.76 µg/mL
0.5 mL of 1.76 µg/mL solution	4.5 mL of CBB	176 ng/mL
1 mL of 176 ng/mL solution	9 mL of CBB	17.6 ng/mL (100 nM)

Procedure

1. Create the Gen5 protocol (see page 129).
2. If you have not already done so, prepare the test solutions (see page 127).
3. Refer to the Pipette Map on page 128 and pipette the solutions into a clean, 96-well solid black plate.
4. Create a Gen5 experiment based on the **Synergy HTX FI_MUB.prt** protocol and read the plate.
5. Calculate and analyze the results as described below.

Results Analysis

Sensitivity Test

1. Calculate the Mean and Standard Deviation of the 16 reads for each of the buffer wells (C9, D9, E9).
2. Among the three buffer wells, find the Median Standard Deviation and corresponding Mean.
3. Calculate the Mean for the 16 reads of the MUB Concentration well (D7).
4. Calculate the Signal-to-Noise Ratio (SNR) using the Mean MUB Concentration and the Buffer Media STD with its corresponding Buffer Mean: $(\text{MUB Mean} - \text{Buffer Mean}) / (3 * \text{Buffer STD})$
5. Calculate the Detection Limit using the known concentration value of MUB and the calculated SNR: $17.6 / \text{SNR}$

Optic Probe	Detection Limit must be less than or equal to:
Top 3 mm	0.16 ng/mL (0.91 nM)

Linearity Test

1. Calculate the Mean of the four wells for each concentration in columns 1–5.
2. Perform linear regression using these values as inputs:

x	y
100	Mean of the 100 nM wells
50	Mean of the 50 nM wells
25	Mean of the 25 nM wells
12.5	Mean of the 12.5 nM wells
6.25	Mean of the 6.25 nM wells

3. Calculate the R-Square value; it must be ≥ 0.9500 to pass.

Pipette Map

❖ Seal the plate with foil or store it in a black polyethylene bag until use.

Perform these steps carefully and refer to the grid that follows.

For the **Sensitivity** test (dark gray wells):

- Pipette 150 μL of CBB buffer into wells C9, D9, and E9.
- Pipette 150 μL of the **17.6 ng/mL** (100 nM) MUB solution into well D7.

For the **Linearity** test (wells C1-F5):

- Use a multi-channel pipette with just four tips installed.
- Pipette 150 μL of buffer solution into wells C2-F5. Discard the tips.
- Pipette 150 μL of the **17.6 ng/mL** (100 nM) solution into wells C1-F1.
- Pipette 150 μL of the 17.6 ng/mL (100 nM) solution into wells C2-F2. Mix the wells using the pipette. Do not discard the tips.
- Aspirate 150 μL from wells C2-F2 and dispense into wells C3-F3. Mix the wells using the pipette. Do not discard the tips.
- Aspirate 150 μL from wells C3-F3 and dispense into wells C4-F4. Mix the wells using the pipette. Do not discard the tips.
- Aspirate 150 μL from wells C4-F4 and dispense into wells C5-F5. Mix the wells using the pipette.
- Aspirate 150 μL from wells C5-F5 and discard.

	1	2	3	4	5	6	7	8	9	10	11	12
A												
B												
C	100 nM	50 nM	25 nM	12.5 nM	6.25 nM				BUF			
D	100 nM	50 nM	25 nM	12.5 nM	6.25 nM		MUB 100 nM		BUF			
E	100 nM	50 nM	25 nM	12.5 nM	6.25 nM				BUF			
F	100 nM	50 nM	25 nM	12.5 nM	6.25 nM							
G												
H												

Protocol Reading Parameters

❖ Your tests may require modifications to some of the parameters below, such as Plate Type or Gain (see “Troubleshooting” on page 120). The Plate Type setting should match the plate you are actually using.

The following table contains the recommended settings for the **Synergy HTX FI_MUB.prt** protocol.

Protocol Name: Synergy HTX FI_ MUB.prt	
Parameter	Default Setting
Plate Type:	Costar 96 black opaque (Mfr. #3915)
Read Step 1	
Kinetic Loop:	Run time :45 seconds Interval: 3 seconds Reads: 16
Read Step Label:	“Sensitivity Read”
Read Well:	D7
Filter Set:	EX 360/40 nm EM 460/40 nm

Optics Position:	Top
Gain:	Auto Scale to High Wells Scale Well: D7 Scale Value: 30000
Delay after Plate Movement:	100 msec
Measurements per Data Point:	50
Dynamic Range:	Standard
Light Source:	Tungsten
Read Height:	1.00 mm
Read Step 2	
Kinetic Loop:	Run time: 1 minute, 35 seconds Interval: 6 seconds Reads: 16
Read Step Label:	"Sensitivity Read Buffer"
Read Wells:	C9–E9
Filter Set:	EX 360/40 nm EM 460/40 nm
Optics Position:	Top
Gain:	Auto Use first filter set gain from FIRST Read Step
Delay after Plate Movement:	100 msec
Measurements per Data Point:	50
Dynamic Range:	Standard
Light Source:	Tungsten
Read Height:	1.00 mm
Read Step 3	
Read Step Label:	"Linearity Read"
Read Wells:	C1–F5
Filter Set:	EX 360/40 nm EM 460/40 nm
Optics Position:	Top
Gain:	Auto Scale to High Wells Scale Well: C1 Scale Value: 30000
Delay after Plate Movement:	100 msec

Measurements per Data Point:	50
Dynamic Range:	Standard
Light Source:	Tungsten

Dispense Module Tests

Applies only to Synergy HTX models with injectors.

BioTek has developed a set of tests that you can perform to ensure that the dispense module performs to specification initially and over time. We recommend that you perform these tests before first use (e.g., during the Initial OQ), and then every three months.

- The **Accuracy Test** is a measure of the mean volume per well for multiple dispenses. The actual weight of the dispensed fluid is compared to the expected weight and must be within a certain percentage to pass. Pass/Fail criteria depends on the per-well volume dispensed: 2.0% for 80 μL , 5.0% for 20 μL , and 20.0% for 5 μL . It is assumed that one gram is equal to one milliliter.

The test uses a single green dye test solution and one 96-well microplate (per injector) to test the three different volumes. The balance is tared with the empty plate, and then the 80 μL dispense is performed for columns 1–4. The fluid is weighed and the balance is tared again (with the plate on the balance). This process is repeated for the 20 μL and 5 μL dispenses. It is assumed that the solutions used are at room temperature. A precision balance (three-place) is used to weigh the plate.

- The **Precision Test** is a measure of the variation among volumes dispensed to multiple wells. For each volume dispensed (80 μL , 20 μL , and 5 μL) to four columns, the %CV (coefficient of variation) of 32 absorbance readings is calculated. Pass/Fail criteria depends on the per-well volume dispensed: 2.0% for 80 μL , 7.0% for 20 μL , and 10.0% for 5 μL . The plate is read in an absorbance reader at 405/750 nm for columns 1–4 and at 630/750 nm for columns 5–12.

The two tests are performed simultaneously and use the same plate.

Failures

If any tests fail, prime the fluid lines and rerun the test(s).

If the test(s) fail again, the injector may require cleaning. See **Preventive Maintenance**.

If tests continue to fail, contact BioTek's Technical Assistance Center.

Required Materials

❖ Manufacturer part numbers are subject to change over time.

- Absorbance reader with 405, 630, and 750 nm filters. The reader must have an accuracy specification of $\pm 1.0\% \pm 0.010$ OD or better and a repeatability specification of $\pm 1.0\% \pm 0.005$ OD or better.

❖ The Synergy HTX may be used if it has passed the Absorbance Plate Test and the Absorbance Liquid Tests described earlier in this chapter.

- Shaker (if the absorbance reader does not support shaking)
- Precision balance with capacity of 100 g minimum and readability of 0.001 g
- 50–200 μ L hand pipette and disposable tips
- Deionized water
- Supply bottles
- 250 mL beaker
- New 96-well, flat-bottom microplates
- BioTek's Green Test Dye Solution (PN 7773003) undiluted, **or** one of the alternate test solutions provided in the next section
- 100 mL graduated cylinder and 10 mL pipettes (if not using BioTek's Green Test Dye Solution)
- Gen5 software installed on the host PC
- Gen5 protocols as defined by the procedure on page 138.

Alternate Test Solutions

❖ 80 μ L of test solution with 150 μ L of deionized water should read between 1.300 and 1.700 OD at 405/750 nm. It is assumed that the solutions used are at room temperature.

If you do not have BioTek's Green Test Dye Solution (PN 7773003), prepare a green test dye solution using one of the following methods:

Using BioTek's Blue and Yellow Concentrate Dye Solutions:

Ingredient	Quantity
Concentrate Blue Dye Solution (PN 7773001, 125 mL)	4.0 mL
QC (Yellow) Solution (PN 7120782, 125 mL)	5.0 mL
Deionized water	90.0 mL

Using FD&C Blue and Yellow Dye Powder:

Ingredient	Quantity per Liter
FD&C Blue No. 1	0.200 grams
FD&C Yellow No. 5	0.092 grams
Tween 20	1.0 mL
Sodium Azide N ₃ Na	0.100 gram
Deionized water	Make to 1 liter

Procedure for Models with Absorbance Capabilities

❖ If you have not already done so, create Gen5 protocols **Synergy HTX Disp 1 Test.prt** and **Synergy HTX Disp 2 Test.prt**. Instructions begin on page 137.

- Prime both dispensers with 4000 µL of deionized water or distilled water.
 - Remove the inlet tubes from the supply bottles. Prime both dispensers with the Volume set to 2000 µL. This prevents the water from diluting the dye.
 - Fill a beaker with at least 20 mL of the green dye solution. Prime both dispensers with 2000 µL of the solution. When finished, remove the priming plate from the carrier.
- In Gen5, create an experiment based on **Synergy HTX Disp 1 Test.prt**.
- Place a new 96-well microplate on the balance and tare the balance.
- Place the plate on the microplate carrier.



Running a dispense procedure without placing a plate in the reader will result in contamination of the reader from spilled liquid.

❖ When each dispense step is finished, you will weigh the plate, record the weight, tare the balance with the plate on it, and then place the plate back on the carrier for the next step.

- Select **Plate > Read** and click **READ**. Gen5 prompts you to empty the tip priming trough.
- When ready, click **OK** at the Load Plate dialog to begin the experiment. The sequence is as follows:
 - Dispense 80 µL/well to columns 1–4.
 - Remove the plate and weigh it. Record the weight and tare the balance.
 - Place the plate on the carrier, and dispense 20 µL/well to columns 5–8.

- d. Remove the plate and weigh it. Record the weight and tare the balance.
 - e. Place the plate on the carrier, and dispense 5 μL /well to columns 9–12.
 - f. Remove the plate and weigh it. Record the weight.
 - g. Manually pipette 150 μL of deionized or distilled water into all 12 columns, on top of the green test dye solution.
 - h. Place the plate on the carrier for a 15-second shake, the “80 μL ” read at 405/750 nm, and the “20 and 5 μL ” read at 630/750 nm.
7. When processing is complete, select **File > Save As**. Enter an identifying file name and click **Save**.
 8. Remove the plate from the carrier and set it aside.
 9. Repeat steps 4–9 using **Synergy HTX Disp 2 Test.prt**.
 10. See **Results Analysis** on page 137 for instructions on analyzing the results.

❖ When all tests are complete, prime both dispensers with at least 5000 μL of deionized water to flush out the green dye solution.

Procedure for Models without Absorbance Capabilities

If you will not be using a BioTek absorbance reader for this procedure, prepare your reader to perform two reads with the following characteristics:

	80 μL Read	20 & 5 μL Read
Primary Wavelength:	405 nm	630 nm
Reference Wavelength:	750 nm	750 nm
Plate Columns:	1–4	5–12

1. If you have not already done so, create the necessary Gen5 protocols as described on page 138.
2. Prime both dispensers with 4000 μL of deionized or distilled water.
3. Remove the inlet tubes from the supply bottles. Prime both dispensers with the Volume set to 2000 μL . This prevents the water from diluting the dye.
4. Fill a beaker with at least 20 mL of the green dye solution. Prime both dispensers with 2000 μL of the solution. When finished, remove the priming plate from the carrier.
5. In Gen5, create an experiment based on the **Synergy HTX Disp 1 Test No Read** protocol.
6. Place a new 96-well microplate on the balance and tare the balance.
7. Place the plate on the microplate carrier.

❖ When each dispense step is finished, you will weigh the plate, record the weight, tare the balance with the plate on it, and then place the plate back on the carrier for the next step.

8. Initiate a plate read. Gen5 will prompt you to empty the tip priming trough.
9. When ready, click **OK** at the Load Plate dialog to begin the experiment. The sequence is as follows:
 - Dispense 80 μL /well to columns 1–4.
 - Remove the plate and weigh it. Record the weight and tare the balance.
 - Place the plate on the carrier and dispense 20 μL /well to columns 5–8.
 - Remove the plate and weigh it. Record the weight and tare the balance.
 - Place the plate on the carrier and dispense 5 μL /well to columns 9–12.
 - Remove the plate and weigh it. Record the weight.
 - Manually pipette 150 μL of deionized or distilled water into all 12 columns, on top of the green test dye solution.
 - Carefully set the plate aside.
10. Close the experiment without saving it.

❖ If you are **not** using a BioTek reader for taking the absorbance measurements, read the plate using the wavelengths shown in the table on the previous page, and then perform the Results Analysis as described on page 137.

11. Configure Gen5 to communicate with the reader.
12. Create an experiment based on the **Synergy HTX Disp Test 1 (or 2) Other Reader** protocol.
13. Initiate a plate read. Place the plate on the carrier and click **OK** at the Load Plate dialog. The absorbance reader will:
 - Shake the plate for 15 seconds.
 - Perform the “80 μL ” read at 405/750 nm.
 - Perform the “20 and 5 μL ” read at 630/750 nm.
14. When processing is complete, save the file with an identifying name.
15. Repeat steps 5–14 using the **Synergy HTX Disp 2 Test No Read** protocol for the dispense portion.
16. See page 137 for instructions on analyzing the results.

❖ When all tests are complete, prime both dispensers with at least 5000 μL of deionized water, to flush out the green dye solution.

Results Analysis

❖ For your convenience, we've included a worksheet at the end of this chapter for recording the dispense weights, Delta OD values, calculations, and pass/fail. Make two copies of this worksheet—one for each dispenser tested.

The pass/fail criteria for each set of 32 wells with the same dispense volume is based on the calculated coefficient of variation (%CV) and Accuracy % Error.

For each volume dispensed (80, 20, 5 µL), for each dispenser (1, 2):

- Calculate the Standard Deviation of the 32 wells
- Calculate the Mean of the 32 wells
- Calculate the %CV: (Standard Deviation / Mean) * 100
- Calculate the Accuracy % Error:
((Actual Weight - Expected Weight) / Expected Weight) * 100

❖ Expected Weights for 32 wells: 80 µL (2.560 g), 20 µL (0.640 g), 5 µL (0.160 g). It is assumed that one gram is equal to one milliliter.

Dispense Volume	To pass, % CV must be:	To pass, Accuracy % Error must be:
80 µL	≤ 2.0%	≤ 2.0%
20 µL	≤ 7.0%	≤ 5.0%
5 µL	≤ 10.0%	≤ 20.0%

Failures

If any tests fail, prime the fluid lines and rerun the test(s). If the test(s) fail again, the injector heads may require cleaning (see **Preventive Maintenance**).

If tests continue to fail, contact BioTek's Technical Assistance Center.

Gen5 Test Protocols for Models with Absorbance Capabilities

❖ Perform these steps to create a protocol to test Dispenser 1. Then, open a copy of the protocol and change the relevant parameters for Dispenser 2.

1. Select **System > Instrument Configuration**, and add/configure the **Synergy HTX** (if it is not already there).

2. Create a new protocol, and define the procedure with the steps and settings as described in this table:

Procedure Steps		
#	Step Type	Details
1	Dispense	Dispenser <select 1 or 2, depending on the protocol> Dispense to wells A1..H4 Tip prime before this dispense step, 20 µL Dispense 80 µL at rate 275 µL/sec
2	Plate Out,In	Suggested comment: <i>Weigh the plate (80 uL test). RECORD the weight, TARE the balance. Place the plate back on the carrier. Click OK to continue.</i>
3	Dispense	Dispenser <select 1 or 2, depending on the protocol> Dispense to wells A5..H8 Tip prime before this dispense step, 20 µL Dispense 20 µL at rate 250 µL/sec
4	Plate Out,In	Suggested comment: <i>Weigh the plate (20 uL test). RECORD the weight, TARE the balance. Place the plate back on the carrier. Click OK to continue.</i>
5	Dispense	Dispenser <select 1 or 2, depending on the protocol> Dispense to wells A9..H12 Tip prime before this dispense step, 5 µL Dispense 5 µL at rate 225 µL/sec
6	Plate Out,In	Suggested comment: <i>Weigh the plate (5 uL test). RECORD the weight. PIPETTE 150 ul/well of DI water into all 12 columns. Place the plate back on the carrier. Click OK to perform the Read steps.</i>
7	Shake	Medium intensity for 15 seconds
8	Read	Step label: "80 uL Read_Disp 1" (or _Disp 2) Wells: A1..H4 Detection Method: Absorbance Read Type: Endpoint Read Speed: Normal Two Wavelengths: 405 and 750 nm
9	Read	Step label: "20 and 5 uL Read_Disp 1" (or _Disp 2) Wells: A5..H12 Detection Method: Absorbance Read Type: Endpoint Read Speed: Normal Two Wavelengths: 630 and 750 nm

3. Create **Data Reduction** steps to calculate Delta OD values:
 - Select **Protocol > Data Reduction** and select **Custom**.
 - Within this dialog, click the **Select Multiple Data Sets** button and then click the **DS2** radio button.
 - Set the **Data In** for **DS1** to the **80** μ L Read step at **405** nm.
 - Set the **Data In** for **DS2** to the **80** μ L Read step at **750** nm.
 - Click **OK** to return to the dialog.
 - In the **New Data Set Name** field, type an identifying name such as 'Delta OD 80 uL_Dis 1'.
 - Clear **Use single formula for all wells**.
 - In the **Current Formula** field, type **DS1-DS2** and then assign the formula to wells **A1** to **H4**.
 - Click **OK** to add the transformation to the Data Reduction list.
 - Create another Transformation similar to the above, with these characteristics:
 - **DS1** set to the **20 and 5** μ L Read step at **630** nm
 - **DS2** set to the **20 and 5** μ L Read step at **750** nm
 - **New Data Set Name** resembling 'Delta OD 20 and 5 uL_Dis <#>'
 - Formula **DS1-DS2** applied to wells **A5** to **H12**
4. (This step is optional.) The results analysis worksheet at the end of this chapter requires the calculation of the Standard Deviation, Mean, and % CV of the ODs read for each dispense volume in each plate (six sets of calculations). By identifying the wells by their dispense volumes in the Plate Layout, Gen5 will calculate these values for you.
 - Open the Plate Layout dialog.
 - Define three Assay Control IDs and assign them to the following wells:
 - **Disp_80** A1 to H4
 - **Disp_20** A5 to H8
 - **Disp_5** A9 to H12

❖ After running the experiment, view the Statistics for each Delta OD Data Set to view the calculations.

5. Save the protocols as **Synergy HTX Disp 1 Test.prt** and **Synergy HTX Disp 2 Test.prt**.

Gen5 Test Protocols for Models without Absorbance Capabilities

The test procedure on page 135 dispenses three volumes of fluid to a microplate and then reads the plate on an absorbance reader. The procedure is performed twice, once for each

dispenser. You will create two Gen5 protocols to perform the dispense steps. If you will use a BioTek absorbance reader that is supported by Gen5, you will create one additional protocol to perform the Read step.

Create the Dispense Protocols

❖ Perform these steps to create a protocol to test Dispenser 1. Then, open a copy of the protocol and change the relevant Procedure parameters to Dispenser 2.

1. In Gen5, create a new protocol.
2. Define the procedure with the steps and settings as described in this table:

#	Step Type	Details
1	Dispense	Dispenser <select 1 or 2, depending on the protocol> Dispense to wells A1..H4 Tip prime before this dispense step, 20 µL Dispense 80 µL at rate 275 µL/sec
2	Plate Out,In	Suggested comment: Weigh the plate (80 uL test). RECORD the weight, TARE the balance. Place the plate back on the carrier. Click OK to continue.
3	Dispense	Dispenser <select 1 or 2, depending on the protocol> Dispense to wells A5..H8 Tip prime before this dispense step, 20 µL Dispense 20 µL at rate 250 µL/sec
4	Plate Out,In	Suggested comment: Weigh the plate (20 uL test). RECORD the weight, TARE the balance. Place the plate back on the carrier. Click OK to continue.
5	Dispense	Dispenser <select 1 or 2, depending on the protocol> Dispense to wells A9..H12 Tip prime before this dispense step, 5 µL Dispense 5 µL at rate 225 µL/sec
6	Plate Out,In	Suggested comment: Weigh the plate (5 uL test). RECORD the weight. Set the plate aside and click OK.
7	Read	Wells: A1 Detection Method: <select any valid method> Read Type: Endpoint Read Speed: Normal Wavelength: <select any valid wavelength(s)>
The Read step is necessary because Gen5 requires a Read step within any Dispense procedure. When the test is run, the measurement value is not used.		

3. Save the protocols as **Synergy HTX Disp 1 Test No Read.prt** and **Synergy HTX Disp 2 Test No Read.prt**.

Create the Read Protocol (if needed)

1. In Gen5, create a new protocol for the BioTek reader.
2. Define the **Procedure** with the steps and settings as described in this table:

#	Step Type	Details
1	Shake	15 seconds
2	Read	Step label: "80 uL Read" Wells: A1..H4 Detection Method: Absorbance Read Type: Endpoint Read Speed: Normal Two Wavelengths: 405 and 750 nm
3	Read	Step label: "20 and 5 uL Read" Wells: A5..H12 Detection Method: Absorbance Read Type: Endpoint Read Speed: Normal Two Wavelengths: 630 and 750 nm

3. Create **Data Reduction** steps to calculate Delta OD values:
 - Select **Protocol > Data Reduction** and select **Custom**.
 - Within this dialog, click the **Select Multiple Data Sets** button and then click the **DS2** radio button.
 - Set the **Data In** for **DS1** to the **80 µL Read** step at **405 nm**.
 - Set the **Data In** for **DS2** to the **80 µL Read** step at **750 nm**.
 - Click **OK** to return to the dialog.
 - In the **New Data Set Name** field, type an identifying name such as 'Delta OD 80 uL_Disp 1'.
 - Clear **Use single formula for all wells**.
 - In the **Current Formula** field, type **DS1-DS2** and then assign the formula to wells **A1** to **H4**.
 - Click **OK** to add the transformation to the Data Reduction list.
 - Create another Transformation similar to the above, with these characteristics:

- **DS1** set to the **20 and 5** μ L Read step at **630** nm
 - **DS2** set to the **20 and 5** μ L Read step at **750** nm
 - **New Data Set Name** resembling 'Delta OD 20 and 5 uL_Disp <#>'
 - Formula **DS1-DS2** applied to wells **A5** to **H12**
4. (This step is optional.) The results analysis worksheet at the end of this chapter requires the calculation of the Standard Deviation, Mean, and % CV of the ODs read for each dispense volume in each plate (six sets of calculations). By identifying the wells by their dispense volumes in the Plate Layout, Gen5 will calculate these values for you.
- Open the Plate Layout dialog.
 - Define three Assay Control names as Disp_80, Disp_20, and Disp_5.
 - Assign Disp_80 to wells A1 to H4.
 - Assign Disp_20 to wells A5 to H8.
 - Assign Disp_5 to wells A9 to H12.

❖ After running the experiment, view the Statistics for each Delta OD Data Set to view the calculations.

- Save the protocol as **Synergy HTX Disp Test Other Reader.prt**.

Synergy HTX Dispense Accuracy & Precision Tests—Dispenser # _____

80 µL Dispense Delta ODs @405/750 nm				
1	2	3	4	
				A
				B
				C
				D
				E
				F
				G
				H

80 µL weight: g
 Expected weight: 2.5600 g

Accuracy % Error: %
 Must be <= 2.0% P F

Standard Deviation:
 Mean:

%CV: %
 Must be <= 2.0% P F

Reader Model: _____
 Reader S/N: _____
 Reading Date: _____
 Comments: _____

20 µL Dispense Delta ODs @630/750 nm				
5	6	7	8	

20 µL weight: g
 Expected weight: 0.6400 g

Accuracy % Error: %
 Must be <= 5.0% P F

Standard Deviation:
 Mean:

%CV: %
 Must be <= 7.0% P F

Tested By: _____
 Signature: _____

5 µL Dispense Delta ODs @630/750 nm				
9	10	11	12	
				A
				B
				C
				D
				E
				F
				G
				H

5 µL weight: g
 Expected weight: 0.1600 g

Accuracy % Error: %
 Must be <= 20.0% P F

Standard Deviation:
 Mean:

%CV: %
 Must be <= 10.0% P F

Reviewed/
 Approved By: _____
 Signature: _____

Appendix A

Specifications

This appendix contains BioTek's published specifications for the Synergy HTX.

General Specifications.....	144
Absorbance Specifications	145
Fluorescence Specifications.....	147
Luminescence Specifications	148
Models with Injectors.....	149

General Specifications

Microplates	
All models accommodate standard 6-, 12-, 24-, 48-, 96- and 384-well microplates with 128 x 86 mm geometry up to 1.125" (28.575 mm) high, and the Take3 and Take3 Trio Micro-Volume Plates.	
Hardware & Environmental	
Light Source:	<p>Absorbance: Xenon flash light source, 10W maximum average power</p> <p>Fluorescence: Tungsten halogen, 20W power</p>
Dimensions:	16" D x 16" W x 10" H (40.6 cm x 40.6 cm x 25.4 cm)
Weight:	38 lb. (17 kg)
Environment:	Operational temperature 18°C (64°F) to 40°C (104°F)
Humidity:	10% to 85% relative humidity (noncondensing)
Power Supply:	24-volt 90W external power supply compatible with 100-240 V~; $\pm 10\%$ @50-60 Hz
Power Consumption:	100 VA max, 130 VA max with injectors
Incubation:	<p>Temperature control range from 4° over ambient to 50°C. Temperature variation $\pm 0.5^\circ\text{C}$ at 37°C, tested with Innovative Instruments, Inc. temperature test plate</p> <p>Top and bottom incubation controlled via software-adjustable gradient.</p>
Plate Shaking:	<p><i>*Frequency is based on the amplitude selected</i></p> <p>Linear: Amplitude: 1 mm to 6 mm in 1-mm steps Frequency: 18 Hz to 6 Hz</p> <p>Orbital Slow: Amplitude: 1 mm to 6 mm in 1 mm steps Frequency: 10 Hz to 3 Hz</p> <p>Orbital Fast: Amplitude: 1 mm to 6 mm in 1-mm steps Frequency: 14 Hz to 5 Hz</p>

Absorbance Specifications

Accuracy, Linearity, Repeatability	
<i>All qualifications were conducted using 96-/384-well, flat-bottom microplates. For the performance described here, the Gain on the Optics Test should be below 10.0.</i>	
Measurement Range:	0.000 to 4.000 OD
Accuracy (tested with certified neutral density glass):	
96-well plate, normal read speed:	
0.000 to 2.000 OD $\pm 1.0\%$ ± 0.010 OD, Delay after plate movement: 100 ms	
2.000 to 3.000 OD $\pm 3.0\%$ ± 0.010 OD, Delay after plate movement: 100 ms	
384-well plate, normal read speed:	
0.000 to 2.000 OD $\pm 2.0\%$ ± 0.010 OD, Delay after plate movement: 100 ms	
2.000 to 2.500 OD $\pm 3.0\%$ ± 0.010 OD, Delay after plate movement: 100 ms	
96-well and 384-well plate, sweep read speed:	
0.000 to 1.000 OD $\pm 1.0\%$ ± 0.010 OD	
Linearity (by liquid dilution):	
96-well plate, normal read speed:	
0.000 to 2.000 OD $\pm 1.0\%$ ± 0.010 OD, Delay after plate movement: 100 ms	
2.000 to 3.000 OD $\pm 3.0\%$ ± 0.010 OD, Delay after plate movement: 100 ms	
384-well plate, normal read speed:	
0.000 to 2.000 OD $\pm 2.0\%$ ± 0.010 OD, Delay after plate movement: 100 ms	
2.000 to 2.500 OD $\pm 3.0\%$ ± 0.010 OD, Delay after plate movement: 100 ms	
96-well and 384-well plate, sweep read speed:	
0.000 to 1.000 OD $\pm 1.0\%$ ± 0.010 OD	
Repeatability (tested with certified neutral density glass measured by one standard deviation (8 measurements per data point):	
96-well and 384-well plate, normal read speed:	
0.000 to 2.000 OD $\pm 1.0\%$ ± 0.005 OD, Delay after plate movement: 100 ms	
2.000 to 3.000 OD $\pm 3.0\%$ ± 0.005 OD, Delay after plate movement: 100 ms	
96-well and 384-well plate, sweep read speed:	
0.000 to 1.000 OD $\pm 2.0\%$ ± 0.010 OD	

Optics	
λ range:	200 to 999 nm
λ accuracy:	± 2 nm
λ precision:	± 0.2 nm (standard deviation)
λ bandpass:	2.4 nm
Resolution:	0.0001 OD
Increment:	1 nm
Minimum kinetic interval (450 nm):	Sweep mode, < 20 seconds, 96-well plate
Time elapse from plate in to plate out (450 nm):	Sweep mode, <35 seconds, 96-well plate

Fluorescence Specifications

Read Timing	
<i>Because of the possible wide variations in setup, the following benchmark conditions are specified:</i>	
Excitation Filter:	485/20 nm
Emission Filter:	528/20 nm
Measurements per data point:	10
Delay after plate movement:	100 ms
Minimum kinetic interval, 96-well	<55 seconds

Optical Probes
The Synergy HTX is configured with two probe sizes: The 3 mm probes can be installed only in the top position, and the 5 mm probe can be installed only in the bottom position.

Sensitivity	
<i>Specifications apply to the Normal mode of reading</i>	
5 mm optical probe Bottom reading	DL Sodium Fluorescein in PBS <= 30 pM Excitation 485/20, Emission 528/20 DL Propidium Iodide in PBS <= 62.5 ng/mL Excitation 485/20, Emission 645/40
3 mm optical probe Top reading	DL Methylumbelliferone in CBB <=0.16 ng/mL Excitation 360/40, Emission 460/40

Optional Time-Resolved Fluorescence ("T" models)	
Delay:	0, or 20 to 2,000 μ s
Integration Time:	20 to 2,000 μ s
Granularity:	10- μ s step

Luminescence Specifications

Luminescence
≤ 60 amol/well DL ATP in a 96-well plate (low-noise PMT) , 20 amol typical
≤ 500 amol/well in a 96-well plate (red-shifted PMT)
10-second integration, PMT sensitivity 150, 16 blank wells

Models with Injectors

Dispense/Read	
<i>Specifications apply to models with the dual-reagent dispense module</i>	
Plate Type:	Dispenses to standard 6-, 12-, 24-, 48-, 96-, and 384-well microplates with 128 x 86 mm geometry
Detection Method:	Absorbance, Fluorescence, Luminescence, TRF
Volume Range:	5-1000 μ L with a 5-20 μ L tip prime
Accuracy:	\pm 1 μ l or 2.0%, whichever is greater
Precision:	Dispensing a 200 μ L solution of deionized water, 0.1% Tween 20, and dye at room temperature: \leq 2.0% for volumes of 50-200 μ L \leq 4.0% for volumes of 25-49 μ L \leq 7.0% for volumes of 10-24 μ L \leq 10.0% for volumes of 5-9 μ L
Injection Speeds:	225, 250, 275, and 300 μ L/sec
Maximum Delay between End of Dispense Process and Start of Read Process (96-/384-well plates, default probe heights only)	Absorbance: T \leq 3 sec Top Filter Fluorescence: T \leq 1 sec Bottom Filter Fluorescence: T \leq 1 sec Luminescence: T \leq 0.5 sec

Appendix B

Error Codes

This appendix lists and describes Synergy HTX error codes that may appear in Gen5.

Error Codes Overview	152
Contact Info: BioTek Service/TAC	152
Error Codes	153

Error Codes Overview

When a problem occurs during operation of the Synergy HTX, an error code appears in Gen5. Error codes typically contain four characters, such as “2101,” and in most cases are accompanied by descriptive text. With many errors, the instrument will beep repeatedly; press the carrier eject button to stop this alarm.

Some problems can be solved easily, whereas others can be solved only by trained BioTek service personnel. This appendix lists the most common and easily resolved error codes that you may encounter.

❖ Error codes beginning with “A” (e.g., A100) indicate conditions that require immediate attention. If this type of code appears, turn the instrument off and on. If the system test does not conclude successfully, record the error code and contact BioTek’s Technical Assistance Center.

If an error code appears in Gen5, you should run a system test for diagnostic purposes. In Gen5, select **System > Diagnostics > Run System Test**. Having the system test report before calling the BioTek’s Technical Assistance Center can speed the resolution of the error.



If an error message appears while an experiment is in process and after having received measurement data, it is your responsibility to determine if the data is valid.

Contact Info: BioTek Service/TAC

Use this appendix to diagnose problems and solve them if possible. If you need further assistance, record the following information and contact BioTek’s Technical Assistance Center:

- Ensure the error code is repeatable.
- Note the conditions (i.e., what the instrument was doing, was a protocol running, etc.) when the error occurred.
- Write down the serial number of the instrument and run and print a self-test.

Phone: 800-242-4685 (toll-free in the U.S.)

802-655-4740 (outside the U.S.)

Fax: 802-654-0638

E-mail: tac@biotek.com

❖ For errors that are displayed during operation of the Synergy HTX with the stacker, refer to the *BioStack Operator’s Manual*.

Error Codes

This table lists the most common and easily resolved error codes that you may encounter. If an error code appears in Gen5, look for it here. If you find the code, follow the suggestions provided for solving the problem. If you cannot find the code, or if you are unable to solve the problem, please contact BioTek's Technical Assistance Center. The Gen5 Help system also provides troubleshooting tips.

Code	Description and Probable Causes:
0200	<p>24VDC dropped below safe level.</p> <ul style="list-style-type: none"> • External power supply has failed. • Verify connection to AC mains. • Power supply connection to instrument is loose or broken. <p>Contact BioTek TAC.</p>
150x	<p>Temperature is out of range.</p> <p>External 24-volt power supply is low.</p> <ul style="list-style-type: none"> • x=1: Zone 1 • x=2: Zone 2 • x=3: Zones 1 and 2 • x=4: Zone 3 • x=5: Zones 1 and 3 • x=6: Zones 2 and 3 • x=7: Zones 1, 2, and 3 • x=8: Zone 4 • x=9: Zones 1 and 4 • x=A: Zones 2 and 4 • x=B: Zones 1, 2, and 4 • x=C: Zones 3 and 4 • x=D: Zones 1, 3, and 4 • x=E: Zones 2, 3, and 4 • x=F: Zones 1, 2, 3, and 4 <p>Contact BioTek TAC.</p>
152x	<p>One or more incubator zones are defective.</p> <ul style="list-style-type: none"> • x=1: Zone 1 • x=2: Zone 2 • x=3: Zones 1 and 2 • x=4: Zone 3 • x=5: Zones 1 and 3 • x=6: Zones 2 and 3 • x=7: Zones 1, 2, and 3 • x=8: Zone 4 • x=9: Zones 1 and 4 • x=A: Zones 2 and 4

Code	Description and Probable Causes:
	<ul style="list-style-type: none"> • x=B: Zones 1, 2, and 4 • x=C: Zones 3 and 4 • x=D: Zones 1, 3, and 4 • x=E: Zones 2, 3, and 4 • x=F: Zones 1, 2, 3, and 4 <p>Turn the incubator on and wait at least 10 minutes for it to stabilize. Contact BioTek TAC.</p>
2101	<p>Plate dimensions incorrect. Row count < 1 or > 99.</p> <p>Review plate type defined in protocol. Ensure counts or dimensions do not exceed limits. Contact BioTek TAC.</p>
2102	<p>Plate dimensions incorrect. Column count < 1 or > 99.</p> <p>Review plate type defined in protocol. Ensure counts or dimensions do not exceed limits. Contact BioTek TAC.</p>
2109	<p>Plate dimensions incorrect. Plate height > 28.575 mm.</p> <p>Review plate type defined in protocol. Ensure counts or dimensions do not exceed limits. Contact BioTek TAC.</p>
230x	<p>Plug not found in filter wheel.</p> <p>x=2: excitation filter wheel x=3: emission filter wheel</p> <p>Protocol contains a plug in a filter wheel, but it was not found. Verify that the plug is physically installed and that this is accurately reflected in the filter table.</p>
2313	<p>Empty hole not found in emission filter wheel.</p> <p>Protocol contains an empty hole in the emission filter wheel, but it was not found. Verify that an empty hole is in the emission filter wheel and that this is accurately reflected in the filter table.</p>
2326	<p>TRF cartridge not installed.</p> <p>Protocol calls for TRF, but the TRF block is not installed in the excitation filter wheel slot. Verify that the TRF block is physically installed and that this is accurately reflected in the filter table.</p>
2327	<p>Excitation filter wheel not installed.</p> <p>Verify that the excitation filter wheel is physically installed.</p>
240x	<p>Read area of the plate will not fit in the inside open area of the carrier.</p> <p>x=3: First row position + Y offset < 2.54 mm or > 83.57 mm x=4: Low row position + Y offset < 2.54 mm or > 83.57 mm x=5: First column position + X offset < 4.57 mm or > 120.65 mm x=6: Last column position + X offset < 4.57 mm or > 120.65 mm</p>

Code	Description and Probable Causes:
	<p>x=7: Plate width < 84.15 mm or > 86.11 mm x=8: Plate length < 125.73 mm or > 128.40 mm Review definition for plate defined in Plate Type database. Ensure counts or dimensions do not exceed limits. See the Gen5 Help for a description of measuring plates.</p>
2B0x	<p>Syringe failure. x=1: Syringe failed to reach home sensor (optical sensor should be on). x=2: Syringe moved off home sensor, but sensor didn't changes state (optical sensor should be off). x=3: Syringe clean position too far from home sensor. x=4: Steps to clear sensor at runtime deviated from value saved when homing (verify error). Protocol definition is incorrect or reader is being controlled by incorrectly programmed third-party software. Syringe was not installed correctly or was not cleaned, preventing a move to home sensor. Contact BioTek TAC.</p>
2B0A	<p>Plate not in carrier for system prime operation. Place priming plate in carrier.</p>
2C01 2C05 2C07	<p>Dispenser configuration incorrect. Volume calibration data is invalid. Volume calibration is needed to override defaults. Verify that the dispenser calibration values have been loaded into Gen5. See the Installation chapter in the <i>Synergy HTX Operator's Manual</i>. Contact BioTek TAC.</p>
2D09	<p>Tip prime volumes specified could overflow the tip priming trough. Empty the tip priming trough. Contact BioTek TAC.</p>
2D0A	<p>Tip prime trough or plate is full or may overflow. Empty the tip priming plate.</p>
2D15	<p>Invalid kinetic interval selected for plate mode/plate synchronous mode. Enter a valid kinetic interval. Call BioTek TAC.</p>
2D16	<p>Assay missed scheduled start of read (well synchronous mode). Verify computer setup. Hibernate or sleep mode should not be enabled. Contact BioTek TAC.</p>
2D22	<p>Invalid volume selected for tip prime. Select a valid volume. Call BioTek TAC.</p>
2D23	<p>Invalid volume selected for dispense. Select a valid volume. Call BioTek TAC.</p>

Code	Description and Probable Causes:
2D24	Invalid rate selected for dispense. Select a valid rate. Call BioTek TAC.
2D28	Dispenser module not attached. Verify the cable is connected. Call BioTek TAC.
2D2A	Dispense not primed successfully. Reinitialize the dispenser, then repeat the prime operation. Contact BioTek TAC.
2D46	Invalid wavelength specified. Wavelength must be between 230 and 999 nm.
3700 3710 3800 3810	Absorbance reference channel failed noise test. Absorbance measurement channel failed noise test. Absorbance reference channel failed offset test. Absorbance measurement channel failed offset test. Humidity is outside the environmental specification of instrument. Note the specification in the operator's manual and move to an area with lower humidity. Too much light in read chamber. Ensure the instrument enclosure is completely installed and secured.
390Y 391Y	Absorbance reference channel dark range outside of limits (measurement < 100 counts), where Y= readset. Absorbance measurement channel dark range outside of limits, where Y = readset. Humidity is outside the environmental specification of instrument. Note the specification in the operator's manual and move to an area with lower humidity. Too much light in read chamber. Ensure the instrument enclosure is completely installed and secured.
3900 3910	Absorbance reference channel dark range outside of limits. Absorbance measurement channel dark range outside of limits. Humidity is outside the environmental specification of instrument. Note the specification in the operator's manual and move to an area with lower humidity. Too much light in read chamber. Ensure the instrument enclosure is completely installed and secured.

Code	Description and Probable Causes:
3E0y	<p>Absorbance reference channel saturated during one of the following steps: Absorbance Blank Data Collection, y=readset # Absorbance Gain Calibration Absorbance Blank Data Collection Absorbance Spectral Scan</p> <p>Too much light in read chamber. Ensure the instrument enclosure is completely installed and secured. Check for spill in chamber or dirty absorbance optics.</p>
3E1y	<p>Absorbance measurement channel saturated during one of the following steps: Absorbance Blank Data Collection, y=readset # Absorbance Gain Calibration Absorbance Blank Data Collection Absorbance Spectral Scan</p> <p>Too much light in read chamber. Ensure the instrument enclosure is completely installed and secured. Check for spill in chamber or dirty absorbance optics.</p>
3F0y	<p>Absorbance reference signal out of range: Absorbance Read Process, y = readset# Absorbance Optics Test</p> <p>Too much light in read chamber. Ensure the instrument enclosure is completely installed and secured. Check for spill in chamber or dirty absorbance optics.</p>
3F1y	<p>Absorbance measurement out of range: Absorbance Read Process, y = readset # Absorbance Optics Test</p> <p>Too much light in read chamber. Ensure the instrument enclosure is completely installed and secured. Check for spill in chamber or dirty absorbance optics.</p>
3F00	<p>Absorbance reference correction value out of range: Absorbance Spectral Scan</p> <p>Too much light in read chamber. Ensure the instrument enclosure is completely installed and secured. Check for spill in chamber or dirty absorbance optics.</p>
4xxx	<p>PMT well overload</p> <p>Sensitivity too high. Chemistry too concentrated. Verify that the physical filter configuration matches the Gen5 Filter Table.</p>
4810	<p>PMT measurement offset test failure (offset is < 700 or > 2450 counts).</p> <p>Too much light in read chamber. Ensure the instrument enclosure is completely installed and secured.</p>

Code	Description and Probable Causes:
4A0X	<p>PMT gain out of range, x = readset. Too much light in read chamber. Ensure the instrument enclosure is completely installed and secured.</p>
4B10 4B11 4B12 4B15 4B18	<p>PMT measurement value is too low. Failed high-voltage PMT test. Failed low-voltage PMT test. Failed well overload test for absorbance or fluorescence. Failed background overload test. Ensure that the Gen5 Filter Table accurately reflects the physical configuration of the excitation and emissions filter wheels. Ensure that the door is fully closed and there is not light leakage.</p>
4E0X 4E11 4E12	<p>Flash-on reference value at full scale during the flash fluorescence read (x=readset #). PMT test failed at 750 volts. PMT test failed at 500 volts. Too much light in chamber. Door not closed completely. Ensure that the Gen5 Filter Table accurately reflects the physical configuration of the excitation or emission filter wheels. Ensure that instrument case is completely installed and secured. Sensitivity set too high; try adjusting sensitivity setting.</p>
4E18	<p>PMT saturation detected. Too much light in chamber. Door not closed completely. Ensure the Gen5 Filter Table accurately reflects the physical configuration of the excitation and emission filter wheels. Ensure the instrument case is completely installed and secured. Sensitivity set too high. Try adjusting sensitivity setting. Fluorescence standards dispensed to plate exceed value established by initial standard values recorded. Contamination within read chamber. Clean read chamber. Verify there is no filter wavelength overlaps between excitation and emission positions 2 and 3.</p>

Code	Description and Probable Causes:
4F0X	<p>Fluorescence signal out of range (too low).</p> <p>Too much light in chamber. Door not closed completely.</p> <p>Ensure the Gen5 Filter Table accurately reflects the physical configuration of the excitation and emission filter wheels.</p> <p>Ensure the instrument case is completely installed and secured.</p> <p>Sensitivity set too high. Try adjusting sensitivity setting.</p> <p>Fluorescence standards dispensed to plate exceed value established by initial standard values recorded.</p> <p>Contamination within read chamber. Clean read chamber.</p> <p>Verify there is no filter wavelength overlaps between excitation and emission positions 2 and 3.</p>
5000 5200	<p>Carrier x-axis failed to home.</p> <p>Shipping screw may be installed.</p> <p>An object may be obstructing the path.</p>
5001 5201	<p>Carrier y-axis failed to home.</p> <p>Y-axis rails are dusty or rusty. Dirt in the roller bearings is causing them to jam.</p> <p>An object may be obstructing the path.</p>
5002 5202	<p>Excitation filter wheel axis failed to home.</p> <p>Filter wheel not inserted correctly.</p> <p>Filter wheel obstructed.</p> <p>Filter not clipped in.</p> <p>Gear teeth of filter wheel binding with gear teeth of the motor. Remove filter wheel, spin wheel by hand, and reinsert.</p>
5003 5203	<p>Emission filter wheel axis failed to home.</p> <p>Filter wheel not inserted correctly.</p> <p>Filter wheel obstructed.</p> <p>Filter not clipped in.</p> <p>Gear teeth of filter wheel binding with gear teeth of the motor. Remove filter wheel, spin wheel by hand, and reinsert.</p>
5006 5206	<p>Probe z-axis failed to home.</p> <p>Shipping bracket not removed.</p>
5402 5403	<p>Excitation filter wheel failed positional verify.</p> <p>Emission filter wheel failed positional verify.</p> <p>Ensure filter cartridge is fully inserted.</p>
5700 5701	<p>Carrier x-axis obstructed.</p> <p>Carrier y-axis obstructed.</p> <p>Axis may have hit probe z-axis.</p> <p>Tip priming trough is not correctly inserted.</p>

Code	Description and Probable Causes:
5702 5703	<p>Excitation filter wheel obstructed.</p> <p>Emission filter wheel obstructed.</p> <p>Ensure filter cartridge is fully inserted.</p>
5706	<p>Probe z-axis obstructed.</p> <p>Shipping bracket not removed.</p> <p>Verify plate height matches selected plate type.</p> <p>Manually turn the z-axis up, remove any microplates from the carrier, and attempt a successful system test.</p>
5708 5709	<p>Dispenser syringe 1 obstructed.</p> <p>Dispenser syringe 2 obstructed.</p> <p>Verify nothing is blocking the syringe drive.</p>
5800 5801	<p>Carrier x-axis obstructed.</p> <p>Carrier y-axis obstructed.</p> <p>Shipping screw still installed.</p> <p>An object may be obstructing the carrier's path.</p>
5A00 5A01	<p>Carrier x-axis obstructed.</p> <p>Carrier y-axis obstructed.</p> <p>Plate has hit something.</p> <p>Plate cover not accounted for when creating plate dimension file.</p> <p>Tip prime trough dislodged.</p>
5B00	<p>Plate height violation.</p> <p>Plate is inside chamber when it should be outside.</p> <ul style="list-style-type: none"> • The read was aborted and "home all axes" not performed. • The carrier is inside the reader and the newly defined plate height is different from the most recently specified plate height. To resolve this error, eject the carrier before running the experiment.