

MultiFlo™ FX Microplate Dispenser

Operator's Manual



**MultiFlo™ FX Multi-Mode Dispenser
Operator's Manual**

**BioTek Instruments, Inc.
May 2014
© May 2014
Part Number 1261000
Revision B**

Notices

BioTek[®] Instruments, Inc.

Highland Park, P.O. Box 998

Winooski, Vermont 05404-0998 USA

All Rights Reserved

© 2014, BioTek[®] Instruments, Incorporated. No part of this publication may be reproduced, transcribed, or transmitted in any form, or by any means electronic or mechanical, including photocopying and recording, for any purpose other than the purchaser's use without written permission of BioTek Instruments, Inc.

Trademarks

BioTek[®] is a registered trademark and **MultiFlo[™] FX Multi-Mode Dispenser** is a trademark of BioTek Instruments, Inc.

Microsoft[®], Internet Explorer[®], Windows[®], Windows 7, Windows 8, Windows Vista[®], Windows XP, and Excel[®] are either registered trademarks or trademarks of Microsoft Corporation in the United States and/or other countries.

All other trademarks are the property of their respective holders.

Restrictions and Liabilities

Information in this document is subject to change and does not represent a commitment by BioTek Instruments, Inc. Changes made to the information in this document will be incorporated in new editions of the publication. No responsibility is assumed by BioTek for the use or reliability of software or equipment that is not supplied by BioTek or its affiliated dealers.

Contents

Notices	ii
All Rights Reserved	ii
Trademarks	ii
Restrictions and Liabilities	ii
Global Service and Support	ix
Revision History	x
Document Conventions	xi
Intended Use Statement	xi
Quality Control	xi
Warranty and Product Registration	xii
Dispense Cassette Warranty	xii
Repackaging and Shipping	xii
Warnings	xii
Hazards and Precautions	xiii
Hazards	xiii
Precautions	xiv
CE Mark	xvi
Directive 2004/108/EC: Electromagnetic Compatibility	xvi
Directive 2006/95/EC Low Voltage (Safety)	xvi
Directive 2002/96/EC: Waste Electrical and Electronic Equipment	xvii
Directive 98/79/EC: In Vitro Diagnostics (if labeled for this use)	xvii
Electromagnetic Interference and Susceptibility	xvii
USA FCC CLASS A	xvii
Canadian Department of Communications Class A	xviii
User Safety	xviii
Safety Symbols	xix
Introduction	1
Introducing the MultiFlo™ FX Dispenser	2
Features of the MultiFlo FX	3
Washer	3
Peri-pump Dispenser	4
Syringe Dispensers	4
Liquid Handling Control™ (LHC) Software	5
RAD™ Technology Features	5
MultiFlo FX Models	6
MultiFlo FX Dispenser Comparison	7
Plate Types Table	9
BioStack Compatibility	10
Package Contents	12
Optional Accessories	13
Peri-pump Optional Accessories	13
Syringe Dispenser Optional Accessories	14

Strip Washer Optional Accessories	15
Physical Specifications	18
Performance Specifications	21
Peri-Pump Dispenser	21
Syringe Dispensers	22
Strip Washer	23
Space Requirements	25
BioTek's Customer Resource Center	26
Installation	27
Unpack and Inspect the Instrument	28
Install the Waste Tubing	29
Remove the Shipping Hardware	31
Set up the Strip Washer	34
Strip Washer accessories	34
Attach washer module and connect its cable	35
Install the tubing bracket	37
Install the Fluid Supply	38
Install the Waste Bottle	39
Install the muffler	41
Install Washer Manifolds	41
Set Up the Peri-pump Dispenser	44
Attach the Peri-pump Cover Panel	44
Install the Secondary Peri-Pump	46
Install RAD Technology Components	51
Install the Tubing Bracket and RAD Module	51
Install the tubing bracket	52
Attach the RAD Module to the Tubing Bracket	52
Install RAD Dispense Head	53
Dispense Cassette Diagram	54
Install the Dispense Cassette	56
Install RAD Technology Cassette	58
Prime Trough Inserts	59
Peri-pump Reservoir Holder	60
Shorten the Dispense Cassette Tubing	61
Install the Syringe Dispenser Component	62
Syringe Dispenser Placement Options	63
Install the Syringe Dispenser on Back Shelf	64
Install the Syringe Dispenser on Top	65
Install Tubing and Manifolds for Syringe Dispenser	68
Syringe Dispenser Check Valves	70
Install Inline Filter for 32-Tube Dispensers	71
Install Software/Connect to Computer	71
Connect to Host Computer	72
Connect Power Cable	72
Define Instrument Settings	73
LHC Users Only	73
Enable Waste Sensor	73

Update the Instrument to use the Syringe Dispenser	74
Change the Syringe Dispenser Manifold	75
Change the cassette type setting	76
Setting the Time and Date	77
Define Startup Preferences (LHC users only)	77
Verify Performance	79
Verify the Peri-Pump Dispenser	80
Verify the Syringe Dispensers	80
Verify the Washer Component	81
Repacking the MultiFlo FX	82
Install the Shipping Hardware	83
Repacking the Secondary Peri-pump	85
MultiFlo FX Repacking	86
Repacking the Syringe Dispenser	89
Repacking the Strip Washer	90
Operation	91
Touch Screen Basics	92
Quick Prime	93
Quick Dispense	94
Quick Wash	95
Add protocols to the Home screen	95
Remove protocols from the Home screen	95
Get protocols from a memory stick - USB drive	96
Hardware Change Detected	96
Optimize Performance	98
Recommended prime volumes for the Strip Washer	99
Recommended prime volumes for the Peri-pump	99
Recommended prime volumes for the Syringe dispensers	101
Optimize protocols to improve evacuation	101
Add a secondary aspiration to a wash cycle	101
Create or Modify a Protocol	102
Protocol Parameters Tables	103
Wash Parameters Table	108
Washer Flow Rates	111
Pre-Dispense	113
Minimum Prime Volumes for the Strip Washer	114
Bottom Wash	114
Change the Plate Type	115
Rename a protocol	115
Shake/Soak Step Parameters	116
Repeat steps in a Loop	116
Delay the Protocol	117
Timer Activated Delay	118
RUN: Running Predefined Protocols	120
LHC Users Only: Customize the Predefined Protocols	120
Predefined Protocols Listing	121
Predefined Sample Protocols	122
Operating with the BioStack	124

Use the BioStack	125
Re-stack plates in the BioStack	127
Nth Plate to perform special process	127
About the Nth Plate Step	128
Advanced Plate Sequencing with the BioStack	129
Plate Types and Processing Patterns	133
Handling Special Plates and Mini-tubes	134
1536F - 1536-well Flanged Plates	134
Peri-pump Special Plate Handling	134
Special Plate Carrier for Mini-tubes	136
Mini-Tube Racks	137
Dispensing to Mini-Tubes	137
Dispense Processing Patterns	138
8-Channel Dispenser Dispense Pattern	139
Dispense Pattern with Both Syringes	140
Washer Operation	141
About the MultiFlo FX Wash Step	141
Cell Wash	142
Define a Cell Wash Protocol	142
Cell Wash Strategies	143
Biomagnetic Separation - Magnetic Bead Assays	145
Perform Magnetic Bead Assays	146
Optimize Magnetic Bead Protocols	147
Flat Magnets	147
Ring Magnets	148
How to determine the Magnet Adapter Height Offset	149
Magnet Height Offset	150
Special Procedure for Magnetic Bead Assays	151
Peri-pump Peristaltic Dispenser	152
Peri-pump: How it works	153
Release the tension on the dispense cassette	154
Peri-pump Dispense Step	155
RAD Tip Tracking	156
RAD Well Map	157
Require a Specific Peri-pump Cassette	158
Peri-pump Advanced Settings	159
Settings for 0.5 μ L Dispense	159
8-to-1 Tube RAD Cassette	159
Dual Syringe Dispenser	160
How to Prime the Syringe dispenser	160
Syringe Prime Step	161
Syringe Dispense Step	163
Change the Syringe Dispenser Manifold	165
Syringe Dispenser Settings	166
Syringe Dispenser- Autoclavable vs. Non-autoclavable	167
Changing the Instrument's Settings	168
Dispense Pattern	168

Change the Plate Carrier Setting (Touch screen)	169
Change the Plate Clearance Setting (Touch screen)	169
Plate Carrier Speed	170
Upload-Download Protocols (LHC Only)	170
Transfer Protocols (Touch Screen Only)	170
Transfer Plate Lid Definitions	171
Maintenance	173
Overview	174
Recommended Maintenance Schedule	176
Daily Maintenance	178
Overnight/Multi-Day Maintenance	179
AutoPrime	179
Turn on AutoPrime for the Peri-pump Dispenser	180
Turn on AutoPrime for the Syringe Dispenser	182
Turn on AutoPrime for the Washer	183
Soak the manifold tubes in cleaning fluid	185
Removing Protein Residuals and Fungi Growth	187
Periodic Maintenance	189
Autoclavable Components	190
Clean the Bottles	190
Clean the Plate Carrier	191
Clean the exterior surfaces	191
Peri-pump Dispenser Maintenance	192
Flush the Dispense Cassette	192
Unclog the Dispense Tips	194
RAD Single-tube Cassette - Unclog the Tip	196
RAD 8-to-1 Cassette - Unclog the Tips	197
Record the Number of Plates Processed	199
RAD 8-to-1 Cassette - Replace Chute	200
Syringe Dispenser and Strip Washer Maintenance	201
Clean the Manifolds	201
Clean the Dispense/Aspirate Tubes	202
Clean or Replace the Check Valves	204
Autoclave the Syringe Head	204
Decontamination	205
Tools and Supplies	206
Decontaminate Exterior Surfaces	207
Decontaminate Tubing and Manifold	208
Long Shutdown (Prepare for Storage or Shipment)	208
Storing the Instrument	210
Replace Components	210
Calibrate the Backlash for Syringe Dispenser	212
Qualification	215
Qualification Overview	216
Washer	216
Peri-pump and Syringe Dispensers	216
Qualification Schedule	217

System Self-Test, Verify Information	218
Record Onboard Software	218
Liquid Testing the MultiFlo™ FX Multi-Mode Dispenser	219
Which Tests to Perform?	219
Important Recommendations for All Liquid Tests	220
Peri-pump Dispense Precision and Accuracy Tests	221
Peri-pump Dispenser Test Materials	223
Peri-pump Dispenser Precision and Accuracy Test Solutions	223
Perform the Peri-Pump Precision and Accuracy Tests	224
Syringe Dispenser Liquid Tests	235
Syringe Dispenser Test Materials	236
Syringe Dispenser Test Solutions	236
Perform the Syringe Dispense Precision & Accuracy Test	236
Washer Qualification Liquid Tests	250
Dispense Precision and Accuracy Test	250
Evacuation Efficiency Test	250
Washer Qualification Test Materials	251
Create Washer Qualification Protocols	252
Dispense Precision and Accuracy Test	253
Evacuation Efficiency Test	254
Evacuation Diagnostic Test	256
Troubleshooting	271
Troubleshooting	272
Syringe Dispenser Troubleshooting	273
Dispense Manifold Movement	273
Fluid Delivery	274
Fluid Leakage	276
Microplate Carrier Movement	276
Syringe Movement	277
Peri-pump Troubleshooting	277
Washer Troubleshooting	278
Fluid Aspiration	278
Fluid Delivery	280
Fluid Leakage	282
Error Codes	283
System Error Codes	284
MultiFlo FX Software Error Codes	294
Index.....	301
Chemical Compatibility	306

Global Service and Support

BioTek instrument service and repair is available worldwide at several of BioTek's International Service Centers and in the field at your location. Contact the office nearest you to arrange service or to get answers to your technical questions, call the Technical Assistance Center (TAC) at 802-655-4740 in the US.

BioTek World Headquarters US	BioTek China
Mailing Address: PO Box 998, Highland Park Winsooki, VT 05404-0998 United States	Room 304, Tower D Ocean International Center 62 Middle 4th East Ring Road Chaoyang District Beijing 100024 P.R. China
Service Shipping Address: 15 Tigan Street Winooski, VT 05404 United States	
Phone: (800) 242-4685 Fax: (802) 654-0638	Phone: +86 (10) 85865569 Fax: +86 (10) 85861829
Email: TAC@biotek.com Website: www.biotek.com	Email: infochina@biotek.com Website: www.biotekchina.com.cn

BioTek Germany Service Center & European Coordination Center	BioTek Instruments SAS Bureau de liaison France
Kocherwaldstrasse 34 D-74177 Bad Friedrichshall Germany	50 avenue d'Alsace 68025 Colmar Cedex France
Phone: +49 (0) 71369680 Fax: +49 (0) 7136968111	Phone: +33 (3) 89206329 Fax: +33 (3) 89204379
Email: info@biotek.de Website: www.biotek.de	Email: info@biotek.fr Website: www.biotek.fr

BioTek India	BioTek Singapore
Unit 223, Linkway Estate New Link Road, Malad West Mumbai 400064 India	20 Science Park Road #01-08A Teletech Park Singapore 117674
Phone: +91 (22) 28789966 Fax: +91 (22) 28759944	Phone: +65 65922100 Fax: +65 67772611
Email: biotek@biotek.in	Email: singapore@biotek.in

BioTek India	BioTek Singapore
Website: www.biotek.in	Website: www.biotek.com

BioTek South Korea	BioTek Switzerland
3F, Gyungnam building, 830-48 Yeoksam-dong, Gangnam-gu Seoul, South Korea (135-936)	Zentrum FanhÖfli 8 6014 Luzern Switzerland
Phone: +82 (0) 2-562-4740 Fax: +82 (0) 2-562-4750	Phone: +41 (41) 2504060 Fax: +41 (41) 2505064
Email: korea@biotek.com Website: www.biotekinstruments.co.kr	Email: info@biotek.ch Website: www.biotek.ch

BioTek United Kingdom (UK)	BioTek Japan
6 Bull Street Potton, Bedfordshire SG19 2NR United Kingdom	8F Andoh Building 2-7-1 Taito, Taito-ku Tokyo 110-0016 Japan
Phone: +44 (1767) 262000 Fax: +44 (1767) 262330	Phone: +81 (0)3 5812 8109 Fax: +81 (0)3 5812 8115
Email: info@biotek.uk.com Website: www.biotek.uk.com	Email: infojapan@biotek.com Website: www.biotek.com/ja

Revision History

Rev	Date	Changes
A	10/2013	First Issue
B	5/2014	The manual was updated to add RAD Technology content throughout. Syringe dispenser installation steps were updated to add the "Import from USB" calibration data feature. Added references to new Peri-pump cassette types and new Syringe dispenser manifolds. Added references to and some instructions for running the BioStack 4 to process microplates with lids. Updated the contents of the Cassette Calibration folder to match improvements made to its separately purchased accessory kit: PN 7170017. Refined the procedure to remove proteins from the tubing by emphasizing the need to flush first with buffer.

Document Conventions

This manual uses the following typographic conventions:

- This note format calls attention to important information.



Warnings are presented in this style to call attention to potential hazards and other safety concerns.



This icon calls attention to important safety information.



Tips and suggestions for improving performance are formatted this way.

Navigation instructions: how to get to the function being described

Intended Use Statement

- The MultiFlo™ FX Multi-Mode Dispenser provides microplate priming and dispensing, and when equipped, washing, for ELISA™, fluorescence and chemiluminescence immunoassays, cellular and agglutination assays.
- If the instrument has an "IVD" label it may be used for clinical and non-clinical purposes, including research and development. If there is no such label the instrument may only be used for research and development and non-clinical purposes.

Quality Control

It is considered good laboratory practice to run laboratory samples according to instructions and specific recommendations included in the assay package insert for the test to be conducted. Failure to conduct Quality Control checks could result in erroneous test data.

Warranty and Product Registration

Please take a moment to review the Warranty information that shipped with your product. Please also register your product with BioTek to ensure that you receive important information and updates about the product(s) you have purchased.

You can register online through BioTek's Customer Resource Center (CRC) at www.biotek.com or by calling 888/451-5171 or 802/655-4740.

Dispense Cassette Warranty

The Peri-pump dispense cassettes are backed by BioTek's **Confidence-Plus** lifetime warranty. For the lifetime of the cassette, BioTek guarantees the cassette components (Tip Holder, Center Holder, Tube Tensioner, and Tube Organizer) will withstand steam autoclave conditions of 121°C and 1 bar (750 mmHg) without adversely affecting dispense performance. In the event of a failure of any cassette component previously listed, BioTek will replace the cassette components free of charge.

Repackaging and Shipping

If you need to ship the instrument to BioTek for service or repair, contact BioTek for a **Return Materials Authorization (RMA)** number and use the original packing materials. Other forms of commercially available packaging are not recommended and can void the warranty. If the original packing materials have been damaged or lost, contact BioTek for replacement packing.

Warnings



Operate the instrument on a level, stable surface away from excessive humidity.

When operated in a safe environment, according to the instructions in this document, there are no known hazards associated with the MultiFlo FX. However, the operator should be aware of certain situations that could result in serious injury; these vary depending on the instrument type. See **Hazards** and **Precautions**.

Strict adherence to instrument maintenance and qualification procedures is required to ensure accurate dispense volumes and risk-free operation.

Hazards and Precautions

Hazards

The following hazards are provided to help avoid injury:



Warning! Power Rating. The instrument's power supply or power cord must be connected to a power receptacle that provides voltage and current within the specified rating for the system. Use of an incompatible power receptacle may produce electrical shock and fire hazards.

Warning! Electrical Grounding. Never use a plug adapter to connect primary power to the external power supply. Use of an adapter disconnects the utility ground, creating a severe shock hazard. Always connect the power cord directly to an appropriate receptacle with a functional ground.

Warning! Service. Only qualified technical personnel should perform service procedures on internal components.

Warning! Accessories. Only accessories which meet the manufacturer's specifications shall be used with the instrument.

Warning! Lubricants. Do not apply lubricants to the microplate carrier or carrier track. Lubricant on the carrier mechanism will attract dust and other particles, which may obstruct the carrier path and cause the instrument to produce an error.

Warning! Liquids. Avoid spilling liquids on the instrument; fluid seepage into internal components creates a potential for shock hazard or instrument damage. If a spill occurs while a program is running, abort the program and turn the instrument off. Wipe up all spills immediately. Do not operate the instrument if internal components have been exposed to fluid.

Warning! Unspecified Use. Failure to operate this equipment according to the guidelines and safeguards specified in this manual could result in a hazardous condition.

Warning! Software Quality Control. The operator must follow the manufacturer's assay package insert when modifying software parameters and establishing washing or dispensing methods. **Failure to conduct quality control checks could result in erroneous test data.**



Warning! Internal Voltage. Always turn off the power switch and unplug the power supply before cleaning the outer surface of the instrument.



Warning! Potential Biohazards. Some assays or specimens may pose a biohazard. Adequate safety precautions should be taken as outlined in the assay's package insert. This hazard is noted by the symbol shown here. Always wear safety glasses and appropriate protective equipment, such as chemically resistant rubber gloves and apron.



Warning! Pinch Hazard. Some areas of the instrument or its components can present pinch hazards when the instrument is operating. Depending on the instrument or component, these areas are marked with the symbol shown here. Keep hands/fingers clear of these areas when the instrument is operating.

Precautions

The following precautions are provided to help avoid damage to the instrument:



Caution: Service. The instrument should be serviced by BioTek authorized service personnel. Only qualified technical personnel should perform troubleshooting and service procedures on internal components.

Caution: Spare Parts. Only approved spare parts should be used for maintenance. The use of unapproved spare parts and accessories may result in a loss of warranty and potentially impair instrument performance or cause damage to the instrument.

Caution: Environmental Conditions. Do not expose the instrument to temperature extremes. For proper operation, ambient temperatures should remain within the range listed in the **Specifications** section. Performance may be adversely affected if temperatures fluctuate above or below this range. Storage temperature limits are broader.

Caution: Sodium Hypochlorite. Do not expose any part of the instrument to the recommended diluted sodium hypochlorite solution (bleach) for more than 20 minutes. Prolonged contact may damage the instrument surfaces. Be certain to rinse and thoroughly wipe all surfaces.

Caution: Buffer Solution. Although many precautions have been taken to ensure that the instrument is as corrosion-proof as possible, the instrument is not sealed and liquids can seep into sensitive components. Make sure that any spilled buffer solution is wiped off the instrument. Prolonged exposure to salt solution may corrode parts of the microplate carrier, movement rail, springs, and other hardware.

Caution: Chemical Compatibility. Some chemicals may cause irreparable damage to the instrument. The following chemicals have been deemed safe for use in the instrument: buffer solutions (such as PBS), saline, surfactants, deionized water, 70% ethyl, isopropyl, or methyl alcohol, 40% formaldehyde, and 20% sodium hydroxide. Never use acetic acid, DMSO, or other organic solvents. These chemicals may cause severe damage to the instrument.

Contact BioTek for more information and prior to using other questionable chemicals.

Caution: Bovine Serum Albumin. Solutions containing proteins, such as bovine serum albumin (BSA), will compromise the instrument's performance over time unless a strict maintenance protocol is adhered to. See **Maintenance** procedures regarding BSA.

Caution: Power Supply. Only use the power supply shipped with the instrument. Operate this power supply within the range of line voltages listed on it.

Caution: Disposal. This instrument contains printed circuit boards and wiring with lead solder. Dispose of the instrument according to Directive 2002/96/EC, "on waste electrical and electronic equipment (WEEE)," or local ordinances.

Caution: Warranty. Failure to follow preventive maintenance protocols may **void the warranty**.

Caution: Shipping Hardware. All shipping hardware (e.g., shipping bracket etc.) must be removed before operating the instrument and reinstalled before repackaging the instrument for shipment.

Caution: Do not run the Peri-pump without a cassette installed on the pump.

Caution: Electromagnetic Environment. Per IEC 61326-2-6 it is the user's responsibility to ensure that a compatible electromagnetic environment for this instrument is provided and maintained in order that the device will perform as intended.

Caution: Electromagnetic Compatibility. Do not use this device in close proximity to sources of strong electromagnetic radiation (e.g., unshielded intentional RF sources), because these may interfere with the proper operation.

CE Mark

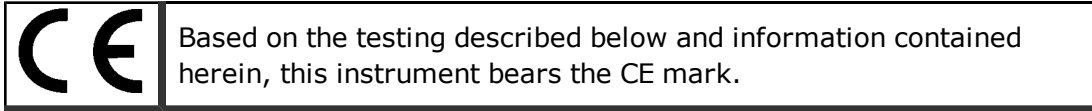

■ **Note:** See the Declaration of Conformity for specific information.

Directive 2004/108/EC: Electromagnetic Compatibility

Emissions—Class A

The system has been type-tested by an independent, accredited testing laboratory and found to meet the requirements of EN 61326-1: Class A for Radiated Emissions and Line Conducted Emissions.

Verification of compliance was conducted to the limits and methods of EN 55011 (CISPR 11) Class A. In a domestic environment it may cause radio interference, in which case, you may need to mitigate the interference.

Immunity

The system has been type-tested by an independent, accredited testing laboratory and found to meet the requirements of EN 61326-1 and EN 61326-2-6 for Immunity. Verification of compliance was conducted to the limits and methods of the following:

EN 61000-4-2, Electrostatic Discharge

EN 61000-4-3, Radiated EM Fields

EN 61000-4-4, Electrical Fast Transient/Burst

EN 61000-4-5, Surge Immunity

EN 61000-4-6, Conducted Disturbances from RFI

EN 61000-4-11, Voltage Dips, Short Interruptions and Variations

Directive 2006/95/EC Low Voltage (Safety)

The system has been type-tested by an independent testing laboratory and was found to meet the requirements of this Directive. Verification of compliance was conducted to the limits and methods of the following:

EN 61010-1, "Safety requirement for electrical equipment for measurement, control and laboratory use. Part 1, General requirements."

EN 61010-2-081, "Particular requirements for automatic and semi-automatic laboratory equipment for analysis and other purposes."

Directive 2002/96/EC: Waste Electrical and Electronic Equipment

Disposal Notice: This instrument contains printed circuit boards and wiring with lead solder. Dispose of the instrument according to Directive 2002/96/EC, "on waste electrical and electronic equipment (WEEE)" or local ordinances.

Directive 98/79/EC: In Vitro Diagnostics (if labeled for this use)

- Product registration with competent authorities.
- Traceability to the U.S. National Institute of Standards and Technology (NIST).

EN 61010-2-101 Particular requirements for in vitro diagnostic (IVD) medical equipment.

Electromagnetic Interference and Susceptibility

USA FCC CLASS A

RADIO AND TELEVISION INTERFERENCE

NOTE: This equipment has been tested and found to comply with the limits for a Class A digital device, pursuant to Part 15 of the FCC Rules. These limits are designed to provide reasonable protection against harmful interference when the equipment is operated in a commercial environment. This equipment generates, uses, and can radiate radio frequency energy and, if not installed and used in accordance with the instruction manual, may cause harmful interference to radio communications. Operation of this equipment in a residential area is likely to cause harmful interference, in which case the user will be required to correct the interference at their own expense.

In order to maintain compliance with FCC regulations shielded cables must be used with this equipment. Operation with non-approved equipment or unshielded cables is likely to result in interference to radio and television reception.

Canadian Department of Communications Class A

This digital apparatus does not exceed Class A limits for radio emissions from digital apparatus set out in the Radio Interference Regulations of the Canadian Department of Communications.

Le present appareil numerique n'émet pas de bruits radioelectriques dépassant les limites applicables aux appareils numerique de la Class A prescrites dans le Reglement sur le brouillage radioelectrique edicte par le ministere des Communications du Canada.















User Safety

This device has been type-tested by an independent laboratory and found to meet the requirements of the following:

- **Underwriters Laboratories UL 61010-1** "Safety requirements for electrical equipment for measurement, control and laboratory use; Part 1: general requirements."
- **Canadian Standards Association CAN/CSA C22.2 No. 61010-1** "Safety requirements for electrical equipment for measurement, control and laboratory use; Part 1: general requirements."
- EN 61010 Standards, see [CE Mark on page xvi](#).

Safety Symbols

Some of these symbols appear on the instrument or accessories:

	Alternating current Courant alternatif Wechselstrom Corrientealterna Correntealternata		Both direct and alternating current Courant continu et courant alternatif Gleich - und Wechselstrom Corriente continua y corrientealterna Corrente continua e correntealternata
	Direct current Courant continu Gleichstrom Corriente continua Corrente continua		Earth ground terminal Borne de terre Erde (Betriebserde) Borne de tierra Terra (difunzionamento)
	On (Supply) Marche (alimentation) Ein (VerbindungmitdemNetz) Conectado Chiuso		Protective conductor terminal Borne de terre de protection Schutzleiteranschluss Borne de tierra de protección Terra diprotezione
	Off (Supply) Arrêt (alimentation) Aus (TrennungvomNetz) Desconectado Aperto (sconnessionedallaretedialimentazione)		Caution (refer to accompanying documents) Attention (voir documents d'accompagnement) AchtungsieheBegleitpapiere Atención (vease los documentosincluidos) Attenzione, consultare la doc annessa
	Warning, risk of electric shock Attention, risque de choc électrique Gefährlicheelektrischeschlag Precaución, riesgo de sacudiaelectrica Attenzione, rischiodiscossaelettrica	 	Warning, risk of crushing or pinching Attention, risqued'écrasement et pincement Warnen, Gefahr des Zerquetschens und Klemmen Precaución, riesgo del machacamiento y sección Attenzione, rischiodischiacciareedintrappolarsi
	Warning, hot surface Attention, surface chaude Warnen, heißeOberfläche Precaución, superficiecaliente Attenzione, superficiecalda		Warning, potential biohazards Attention, risquesbiologiquespotentiels Warnung! MoeglichebiologischeGiftstoffe Atención, riesgosbiológicos Attenzione, rischiobiologico
	In vitro diagnostic medical device Dispositif médical de diagnostic in vitro Medizinisches In-Vitro-Diagnostikum Dispositivo médico de diagnóstico in vitro		Separate collection for electrical and electronic equipment Les équipements électriques et électroniques font l'objet d'une collecte sélective

	<p>vitro Dispositivo medico diagnostico in vitro</p>		<p>Getrennte Sammlung von Elektro- und Elektronikgeräten Recogida selectiva de aparatos eléctricos y electrónicos Raccolta separata delle apparecchiature elettriche ed elettroniche</p>
	<p>Consult instructions for use Consulter la notice d'emploi Gebrauchsanweisung beachten Consultar las instrucciones de uso Consultare le istruzioni per uso</p>		

Introduction

Thank you for purchasing the MultiFlo™ FX Multi-Mode Dispenser. This chapter describes the instrument's features and specifications and includes important contact information.

Introducing the MultiFlo™ FX Dispenser	2
Features of the MultiFlo FX	3
MultiFlo FX Dispenser Comparison	7
BioStack Compatibility	10
Package Contents	12
Optional Accessories	13
Physical Specifications	18
Performance Specifications	21
Space Requirements	25
BioTek's Customer Resource Center	26

Introducing the MultiFlo™ FX Dispenser

The MultiFlo FX offers several devices in one instrument: one or two peristaltic pump dispensers called the **Peri-pump**, a dual **Syringe** pump dispenser, and either a strip **Washer** or a single-channel **Random Access Dispenser (RAD)** module. The MutliFlo FX is available in multiple configurations to support numerous microplate geometries.



	Device/Component	Description
1	Peri-pump Dispenser	Peristaltic, 8-channel dispenser with entirely visible fluid path.
2	Dispense arm	Holds the Peri-pump Tip Holder(s), the Syringe dispenser manifolds and the washer dispense manifold, when applicable.

	Device/Component	Description
3	Aspirate/RAD arm	Washer and RAD models only: holds the strip washer's aspirate manifold or the RAD cassette's tip holder.
4	Priming trough	Waste reservoir for collecting or disposing of priming fluid. Priming trough inserts, for collecting fluid, are shown in this image.
5	Plate Carrier	Holds standard microplates for processing.
6	Touch screen	One of two ways to control the MultiFlo FX; the other way is LHC.
7	Strip Washer	An external module containing a syringe-pump dispenser and vacuum aspiration pump.
8	Syringe Dispenser	Another external module with two distinct syringe-pump dispensers that support a variety of manifold types to process standard and low-density microplates.
9	Peri-pump Dispenser	Secondary or external Peri-pump dispenser (required for RAD models).

See [Plate Types Table on page 9](#) to review the plate types supported by each device.

Features of the MultiFlo FX

- Supports all microplate-based assays, including ELISA, fluorescence, chemiluminescence, RIA, DNA probes, and cellular assays.
- A variety of solutions, including buffered saline and reagents can be dispensed.
- The intuitive onboard software allows you to create and store wash and dispense protocols. BioTek provides numerous predefined protocols for maintenance and instrument qualification purposes.
- Two USB flash drive ports facilitate file transfer and storage.
- A low-maintenance design, the result of BioTek's long history with liquid-handling instruments.
- Compatible with BioTek's BioStack™ Microplate Stacker for automated plate processing.
- A robot-accessible carrier that can be interfaced into some robotic systems.
- Computer control using BioTek's **Liquid Handling Control™ software** ("LHC").

Washer

- Programmable dispense volumes, and a wide range of wash options, from gentle washing for cellular assays to vigorous washing for ELISA™.
- A “bottom washing” routine to lower the background absorbance and “crosswise” or secondary aspiration to reduce residual volumes.
- Supports Wash, Prime, Dispense, and Aspirate steps.
- Several predefined protocols are provided to simplify preventative maintenance, which should be performed regularly to ensure optimum washer performance.

Peri-pump Dispenser

- A peristaltic pump with eight individual tubes transfers fluid from a supply bottle, or up to eight different supply bottles, to various vessels. The pump has four rollers over which the tubing is stretched.
- The tubing is contained in an easy to load and unload cassette that is attached to the pump head. The pump’s protective cover must be in place to run a dispense routine.
- Three tubing sizes are available: 1 µL, 5 µL, and 10 µL for the most precise dispensing of volumes from 1 to 30,000 µL and 0.5 µL dispenses when using a 1 µL cassette.
- [RAD™ Technology](#) models support "random access dispensing" with several single-channel cassette options, including a bulk dispensing cassette (8 tubes to one chute) with flow tracking to minimize turbulence in the wells.
- Autoclavable tubing (steam temperatures and pressures of 121° C and 1 bar (750 mmHg)) is compatible with 70% ethyl or isopropyl alcohol and 0.5% sodium hypochlorite (bleach) solution for easy maintenance.

Syringe Dispensers

- The Syringe dispenser has a long-lasting seal that ensures precise and accurate fluid delivery, as well as reproducibility for repeated dispenses.
- Two syringe pumps support distinct fluid sources and dispense manifolds:
 - 16-channel: one tube per well for 384-well plates and two tubes per well for 96-well plates.
 - 32-channel: one tube per well for 1536-well plates.
 - 8-channel (two manifolds in one block): one tube per well for both 96- and 384-well plates.
- Autoclavable components can be used with organic solvents and provide easy maintenance.
- Does not require recalibration

Low-density Microplate-specific Syringe Manifolds

Plate-specific dispense manifolds with angled dispensing for cellular assays:

- 6-well plate: 8-channel dispense manifold (4 tubes/well).
- 12-well plate: 9-channel dispense manifold (3 tubes/well).
- 24-well plate: 8-channel dispense manifold (2 tubes/well).
- 48-well plate: 12-channel dispense manifold (2 tubes/well).

Liquid Handling Control™ (LHC) Software

BioTek's Liquid Handling Control (LHC) software lets you control the instrument from your computer. You'll enjoy the convenience of programming assay-specific wash and dispense protocols in a familiar Windows environment (Microsoft® Windows® 7, Windows 8, and Windows XP).

For high-throughput applications, the LHC supports BioStack™ integration.

Please refer to the LHC Installation Guide and Help system to learn about:

- Installing the LHC software on the controlling computer
- Running Maintenance protocols
- Running Qualification protocols
- Special considerations when operating with the BioStack Microplate Stacker

RAD™ Technology Features

Random Access Dispensing or RAD models offer the most gentle dispensing possible to support sensitive cellular assays. The single-tube cassettes are ideal for reagent preservation, hit-picking or partial plate filling. The 8-to-1 channel bulk - dispensing cassettes are designed to preserve cell monolayers in low-density plates. An external Peri-pump powers the RAD cassettes, which are not compatible with the internal Peri-pump.

At a glance:

Features	Single-tube	8-to-1 tube
Plate Types	6- to 384-well	6-, 12-, 24-well
Cassette tubing	1 µL, 5 µL, or 10 µL	5 µL only
Primary Uses	Random dispensing in 48-, 96-, and 384-well plates	Fast but gentle dispensing with "Tip Tracking"
Example Application	Dispensing costly reagent - lowest dead volume	Media addition to cells in low-density plates

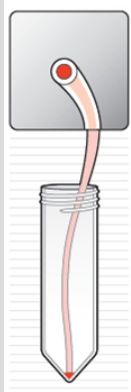
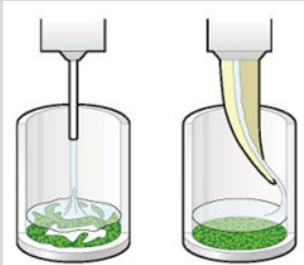
Features	Single-tube	8-to-1 tube
Other	Hit picking: fast, intuitive selection of individual wells, rows, or columns; Access and preserve more reagent: single tube can handle minute quantities of reagent.	Tip Tracking: gradually raises the tip chute as fluid is dispensed to the well to ensure the least disturbance possible. See RAD Tip Tracking on page 156.
		 cell monolayer is preserved

MultiFlo FX Models

Model	Internal Peri-pump	Strip Washer	RAD Technology
MFX			
MFXW		X	
MFXP	X		
MFXPW	X	X	
MFXR			X
MFXPR	X		X

The Syringe and secondary Peri-pump dispensers are ordered separately. Except RAD models include the external Peri-pump.

MultiFlo FX Dispenser Comparison

Counting the washer as a potential dispenser, the MultiFlo FX offers three distinct dispensers. Here is a comparison of the devices:

- For **precious reagents** use the Peri-pump to preserve unused fluids. It has the shortest, most visible fluid path, and a Purge capability to reverse the fluid flow to recover fluid from the tubing. Another advantage is the ability to dedicate a dispense cassette to use with one reagent only, reducing the amount of priming required prior to use. And, you can shorten the tubing to further reduce the dead volume: [See Shorten the Dispense Cassette Tubing on page 61.](#)

- [RAD Technology](#) offers the best tools for preserving cells and reagents.

- All MultiFlo FX devices are capable of dispensing up to 30,000 μL . BioTek's recommended maximum dispense volumes are cited here.

Device	Volume range $\mu\text{L}/\text{well}$	Precision	Accuracy	Approximate Dead volume								
Peri-pump	0.5 \pm , and 1-3000*	<10% CV @ 1 $\mu\text{L}/\text{well}$ (typical <3% CV)	+/-10% (typical +/-3%) @ 1 $\mu\text{L}/\text{well}$	Cassette Type: <table border="1"> <tr> <td>1 μL</td> <td>1.20 mL</td> </tr> <tr> <td>5 μL</td> <td>4.23 mL</td> </tr> <tr> <td>10 μL</td> <td>7.36 mL</td> </tr> </table>	1 μL	1.20 mL	5 μL	4.23 mL	10 μL	7.36 mL		
1 μL	1.20 mL											
5 μL	4.23 mL											
10 μL	7.36 mL											
RAD Technology	0.5 \pm , and 1-30,000*	<10% CV @ 1 $\mu\text{L}/\text{well}$ (typical <3% CV)	+/-10% (typical +/-3%) @ 1 $\mu\text{L}/\text{well}$	<table border="1"> <thead> <tr> <th>Type</th> <th>Dead Vol.</th> </tr> </thead> <tbody> <tr> <td>1 μL</td> <td>150 μL</td> </tr> <tr> <td>5 μL</td> <td>530 μL</td> </tr> <tr> <td>10 μL</td> <td>920 μL</td> </tr> </tbody> </table>	Type	Dead Vol.	1 μL	150 μL	5 μL	530 μL	10 μL	920 μL
Type	Dead Vol.											
1 μL	150 μL											
5 μL	530 μL											
10 μL	920 μL											
Syringe 8-tube/6-well	10-3000	<5% CV @ 20 $\mu\text{L}/\text{well}$	$\pm 2 \mu\text{L}$ @ 10 $\mu\text{L}/\text{well}$	For all manifold types: 12 mL								
Syringe 16-tube	5-3000	<10% CV @ 5 $\mu\text{L}/\text{well}$	$\pm 2 \mu\text{L}$ @ 10 $\mu\text{L}/\text{well}$									
Syringe 12-/24-	5-30,000	<3% CV @	$\pm 2 \mu\text{L}$ @									

Device	Volume range μL/well	Precision	Accuracy	Approximate Dead volume
/48-well		certain μL/well	any μL/well	
Syringe 32-tube	3-3000	<12% CV @ 6 μL/well	±5% @ 6 μL/well	
Strip Washer	20 – 30,000	≤3.0 - 5.0 % CV [‡]	≤±3.0%	12 mL

*1 μL cassettes' maximum recommended dispense volume is 50 μL/well.

‡ 0.5 μL dispensing is supported when using a 1 μL cassette.

‡ Depending on wash manifold, [See Performance Specifications on page 21](#).

BioTek recommends priming a dispenser with three times its dead volume to prepare it for accurate dispensing.

Processing Time §

Protocols were optimized for speed to obtain the following processing times, including the fastest flow and travel rates. Some of these parameters are listed in the Parameters column of the table. Only standard, non-RAD Peri-pump cassettes are referenced here.

Device	Plate Type	Volume (μL/well)	Parameters	Time in seconds [‡]
Peri-pump - 5 μL	96	10	High flow rate	3
Peri-pump - 1 μL	384	1	High flow rate	6
	1536	1	High flow rate	21
Syringe 8-tube	96	20	Flow rate 1	6.5
Syringe 16-tube	96	20	Flow rate 1	5.25
	384	20	Flow rate 1	14
Syringe 32-tube	1536	3	One SB manifold	16.5
	1536	14	One LB manifold	27
Strip Washer	96	300	3 cycles	<105

§ Review the [Specifications](#) for more details.

‡ Excluding plate carrier and manifold homing movements.

SB = small bore Syringe manifold; LB = large bore manifold.

Plate Types Table

Only the Peri-pump can process all plate types. Washer manifolds are named for plate types they process. Only the 32-tube Syringe dispenser manifolds and the Peri-pump can dispense to 1536-well plates.

Plate Type	Columns x Rows	Plate Height	Default Aspirate & Dispense Heights	
		mm	Washer	Dispensers
96 Well	12x8	14.35	84	336
96 Deep Well	12x8	41.50	N/A	929
96 Half Well [^]	12x8	14.20	84	332
96 Mini Tubes	12x8	49.53	N/A	1105
384 Well	24x16	14.22	64	333
384 Deep Well	24x16	44.08	N/A	986
384 PCR	24x16	9.50	6	230
1536 Well	48x32	10.41	N/A	250
1536 Flanged [‡]	48x32	10.26	N/A	196

N/A = Plate washing not supported for this plate type.

Low-Density Plates: Peri-pump (non-RAD), Strip Washer, Syringe					
Plate Type	columns x rows	Plate Ht. (mm)	Dispense Ht. (steps)	PP tubes/well	Washer/Syringe [¥] tubes/well
6 Well	3x2	20.20	465	4*	4
12 Well	4x3	20.20	460	2*	3
24 Well	6x4	20.50	452	2	2
48 Well	8x6	20.10	460	1*	2
Aspirate Ht. default setting = 51 steps (2.07 mm) for all these plate types.					

[^] Syringe dispenser requires standard 8-channel manifold; washer manifold must be 96/384-well.

[‡] Only 1536 Flanged (153F) plates have a "flange height" greater than zero. These plates require

[special handling.](#)

‡Plate-type specific manifolds: The correct volume-per-tube to meet the specified per-well volume is dispensed. (Does not apply to non-RAD Peri-pump cassettes!)

***Important:** when dispensing to 6-, 12-, 24- and 48-well plates (with a non-RAD cassette) some dispense tubes must be removed from the Peri-pump's fluid supply vessel. **See [Handling Special Plates and Mini-tubes](#) on page 134.**

Plate Geometry Diagram

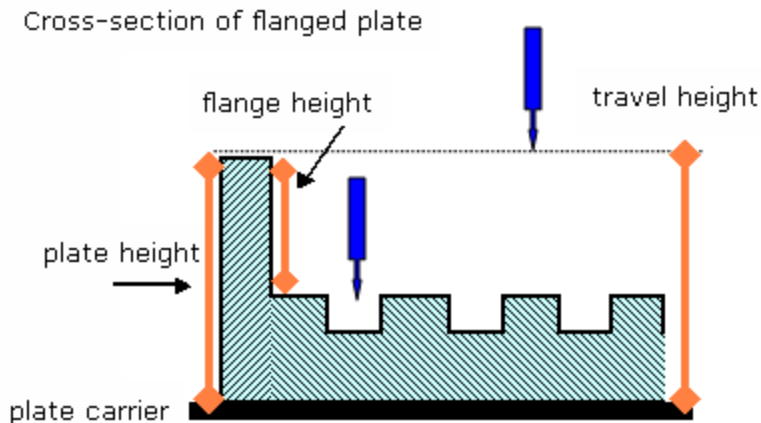

- Plate height = physical measurement
- Default Dispense Height = (plate height - flange height + 1.0 mm)
- Travel Height = (plate height - flange height + [Plate Clearance](#))

■ If the Dispense Height is greater than Travel Height, the travel height is changed to match the dispense height.

BioStack Compatibility

The MultiFlo FX is compatible with BioTek's BioStack Microplate Stacker. The BioStack can rapidly transfer microplates one-at-a-time to and from the instrument, and includes:

- Removable stacks (one input and one output).
- Optional restacking of plates to maintain correct sequencing.
- The ability to continue processing plates following the aborting/failure of one plate.
- The ability to pause processing to allow the user to add more plates to the

input stack or to remove some from the output stack.

- De-lidding and re-lidding capability with BioStack 4.

If you have purchased the BioStack to operate with the MultiFlo FX, refer to the BioStack Operator's Manual for instructions on configuring the MultiFlo FX to run with the BioStack. To help you get started: **See [Operating with the BioStack](#) on page 124.**

If you are interested in purchasing the BioStack, contact your local BioTek dealer for more information or visit our website at www.biotek.com.

Package Contents

- Part numbers and package contents are subject to change and vary according to instrument model. Please contact BioTek Customer Care if you have any questions.

Description	PN
Power cord (part numbers vary by country of use)	Varies
Power supply	76077
RS-232 serial cable	75034
USB cable (USB Virtual COM Port Driver Software & instructions)	75108
Microplate carrier	7170501
Priming trough insert (1 or 2) for Peri-pump	7182043
Priming trough insert for Syringe dispensers (2) and Strip washer or RAD dispenser	7182044
Strip plate (12x1)	98265
Screwdriver, Phillips	98268
Accessory kit	1260004
Stylus: for cleaning washer and Syringe manifold dispense tubes	2872304
10 cc syringe and tubing for Peri-pump cassette maintenance	7210021
Shipping brackets (2) - model dependent	1262010 1262011 1262115
Hex wrench: 7/64" for removing shipping brackets	48169
Peri-pump Reservoir Holder (2 holders + 4 straps)	7212034 7212035
MultiFlo™ FX Getting Started Guide (and operator's manual on USB - PN 1261000)	1261006

- Some components are model specific, they ship only with certain instrument models.

Optional Accessories

- Part numbers and package contents are subject to change and vary according to instrument model. Please contact BioTek Customer Care if you have any questions.

General Instrument Accessories

Description		PN
BioTek liquid testing solutions for instrument qualification tests	Wetting Agent	7773002
	Blue Test Dye	7773001
Special plate carrier for mini-tubes		7212042
Liquid Handling Control™ Software		LHC2
BioStack™ Microplate Stacker and integration kit		Biostack
Installation-Operational-Performance Qualification (IQ-OQ-PQ) package		1260521

Peri-pump Optional Accessories

Secondary Peri-pump assembly: PN 7210010

Dispense cassettes and accessories:

Cassette Type	Cassette	Tips	Replacement tubing kit*	Tubing extension kit
1 µL plastic tips	7170012	7172150	7170009	7170022
1 µL 1536-well, plastic tips	7170018	7172150		
1 µL sapphire jeweled stainless steel tips*	7170015	48692		
1 µL 1536-well, sapphire jeweled stainless steel tips*	7170016	48692		

Cassette Type	Cassette	Tips	Replacement tubing kit*	Tubing extension kit
5 µL plastic tips	7170011	7172059	7170008	7170021
5 µL stainless steel tips	7170014	7172128		
5 µL plastic, large bore tips	7170024	7172039		
10 µL plastic tips	7170010	7172059	7170007	7170020
10 µL stainless steel tips	7170013	7172128		
10 µL plastic, large bore tips	7170024	7172039		

*Save your stainless steel tips for reuse with a replacement kit, they ship with plastic tips.

RAD‡ Technology Cassettes	PN
10 µL Single molded tip	1260015
5 µL Single molded tip	1260016
1 µL Single molded tip	1260017
10 µL Single steel tip	1260018
5 µL Single steel tip	1260019
1 µL Single steel tip	1260021
10 µL Large-bore single molded tip	1260020
Bulk dispenser: 8 tube to 1 chute (5 µL tubing, molded tips)	1260022

‡Random Access Dispenser (RAD)

Accessory	PN
Cassette Calibration Kit	7170017
Peri-pump Reservoir Holder	7210509
40 mL Priming Trough Insert	7182109

Syringe Dispenser Optional Accessories

Accessory	PN
Autoclavable Syringe Dispenser Module: 16-Tube Manifold (2)	7180006S

Accessory	PN
Non-Autoclavable Syringe Dispenser Module	7210009
Autoclavable Syringe Dispenser Module	7210008
8-Tube (2 x 8 channel) Manifold (1)	7180548S
16-Tube Manifolds (2)	7180543S
32-Tube Small Bore (SB) Manifolds (2)	7180533S
32-Tube Large Bore (LB) Manifolds (2)	7180534S
6-Well-Plate Manifold: 8-tubes (4 tubes/well)	1260537S
12-Well-Plate Manifold: 9-tubes (3 tubes/well)	1260536S
24-Well-Plate Manifold: 8-tubes (2 tubes/well)	1260535S
48-Well-Plate Manifold: 12-tubes (2 tubes/well)	1260534S
Stylus – for cleaning 8-/16-tube dispense manifold tubes	2872304
Stylus – for cleaning 32-tube LB dispense manifold tubes	7182095
Stylus – for cleaning 32-tube SB dispense manifold tubes	7182102
Inline Filters (2)	48705
Hex wrench: 3/32" for removing syringe pumps	48570
Hex wrench: 1/16" for removing magnets from dispense manifolds	48713
Spare tubing sets (2 - 1/dispenser), autoclavable	7183006
DMSO- & Acetonitrile-safe tubing sets (2 - 1/dispenser)	7183002
Special large-bore 8-tube manifold for 96-well plates	7180549S

Strip Washer Optional Accessories

Accessory	PN
Fluid Supply Kit	1263007
Waste Bottle and Tubing Kit	1263001
Waste Bottle with Sensor	4070545

Accessory	PN
Spacer Block (substitute for Syringe manifolds)	1262038
Muffler	4073009
Thumb screws	01262
Vacuum Line Filter	48146
Tubing Bracket	1262066

Washer Manifold Kits

Manifold Type	Accessory	PN
96/384-Well	Accessory Kit	1260013
	Dispense Manifold	1262028
	Aspirate Manifold	1262029
6-Well	Accessory Kit	1260009
	Dispense Manifold	1262052
	Aspirate Manifold	1262053
12-Well	Accessory Kit	1260010
	Dispense Manifold	1262050
	Aspirate Manifold	1262051
24-Well	Accessory Kit	1260011
	Dispense Manifold	1262048
	Aspirate Manifold	1262049
48-Well	Accessory Kit	1260012
	Dispense Manifold	1262046
	Aspirate Manifold	1262047

Magnetic Bead Assay Accessories

Accessory	PN
Magnet Adapter (to support the magnet on the plate carrier)	1262063
Magnets:	

Accessory	PN
384-well Flat Magnet	7103017
384-well Ring Magnet	7102215
96-well Flat Magnet	7103016
96-well Ring Magnet	7102216

Physical Specifications

Labware	
Microplates	96-well, 384-well, and 1536-well that comply with ANSI/SLAS microplate standards 1-2004, 2-2004, 3-2004, and 4-2004. 96-well standard, half-height, deep; 384-well standard, deep, PCR; 1536-well standard and flanged. The Peri-pump and plate-type specific washer and syringe manifolds also support 6- (Corning® 3516), 12- (Corning 3513), 24- (Corning 3524), and 48- (Corning 3548) well plates when special handling instructions are followed. Corning 96-Well Cluster Tubes (PN: 4410, 4411), called Mini-tubes in this application, are supported using a special plate carrier.
Microstrips	1 x 8, 1 x 12
Microwells	Flat, round, "V" bottom

Hardware & Environmental	
User Interface	5.7" touch screen
Power Supply	The instrument uses two internal power supplies: 24-volt 60 watt and 48-volt 60 watt. These supplies are compatible with 100-240 V~; 50-60 Hz.
Dimensions (W x D x H)	Approximately 17.19 x 11.75 x 8.0 inches (44 cm x 29 cm x 20 cm) base model (without strip washer, external Peri-pump, or Syringe dispenser).
Weight (≤)	19.5 lb (8.8 kg)
Operating Conditions	10° - 40°C (50° - 104°F)
Relative Humidity	The instrument should be operated in a non-condensing humid environment having a maximum relative humidity of 80% at temperatures up to 31°C decreasing linearly to 50% relative humidity at 40°C.

Peri-Pump

Peristaltic pump: Positive-displacement peristaltic pump with 4 rollers that stretch the 8 tubes (one per channel) to deliver fluid.

Cassette Types	Dispense range	Cassette Life	Dead Volume								
1 μL	0.5, 1 - 30,000 μL	1000 384-well plates @ 5 $\mu\text{L}/\text{well}$	1.2 mL								
5 μL	5 - 30,000 μL	1000 96-well plates @ 50 $\mu\text{L}/\text{well}$	4.2 mL								
10 μL	10 - 30,000 μL	1000 96-well plates @ 100 $\mu\text{L}/\text{well}$	7.4 mL								
RAD™ technology cassettes											
Single-tube (any μL)	0.5*, 1 - 30,000 μL	1 μL : 16,000 wells @ 5 μL	<table border="1"> <thead> <tr> <th>Type</th> <th>Dead Vol.</th> </tr> </thead> <tbody> <tr> <td>1 μL</td> <td>150 μL</td> </tr> <tr> <td>5 μL</td> <td>530 μL</td> </tr> <tr> <td>10 μL</td> <td>920 μL</td> </tr> </tbody> </table>	Type	Dead Vol.	1 μL	150 μL	5 μL	530 μL	10 μL	920 μL
		Type		Dead Vol.							
		1 μL		150 μL							
		5 μL		530 μL							
10 μL	920 μL										
5 μL : 12,000 wells @ 50 μL											
10 μL : 12,000 wells @ 100 μL											
8-to-1 tubes (5 μL)	5 - 30,000 μL	N/A	4.2 mL								

* Requires 1 μL tubing

Syringe Dispenser

Two external positive-displacement syringe pump dispensers which support various manifold types.

Manifold Type	
8-Tube	2 x 8-channel non-autoclavable manifold with replaceable stainless steel tubes to process 96- and 384-well plates.
16-Tube	1 x 16-channel autoclavable manifold with replaceable stainless steel tubes to process 96- and 384-well plates.
32-Tube	1 x 32-channel manifold cannot be autoclaved, and does not support non-factory tube replacement. An inline 90-micron filter is included to minimize clogs. For 1536-well plates only. Two models: large bore (LB) and small bore (SB).
Plate-Type-Specific Manifolds:	
6-Well	1 x 8-channel autoclavable manifold (4 tubes/well) with replaceable stainless steel tubes to process 6-well plates. Tubes are angled 7 degrees to minimize turbulence in the wells.
12-Well	1 x 9-channel autoclavable manifold (3 tubes/well) with replaceable

Manifold Type	
	stainless steel tubes to process 12-well plates. Tubes are angled 7 degrees to minimize turbulence in the wells.
24-Well	1 x 8-channel autoclavable manifold (2 tubes/well) with replaceable stainless steel tubes to process 24-well plates. Tubes are angled 7 degrees to minimize turbulence in the wells.
48-Well	1 x 12-channel autoclavable manifold (2 tubes/well) with replaceable stainless steel tubes to process 48-well plates. Tubes are angled 7 degrees to minimize turbulence in the wells.

Supply bottle volume	Two 1L bottles: glass for autoclavable models or plastic for non-autoclavable.
----------------------	--

Strip Washer

The external strip washer module uses a non-autoclavable positive-displacement syringe pump to dispense fluid and a vacuum pump to aspirate fluid. Its dual-action design uses separate, plate-type-specific manifolds for aspirating and dispensing.

Manifold Type	
96/384-Well	1 x 8-channel dispense and aspirate manifolds to process 96- and 384-well plates.
48-Well	1 x 12-channel dispense manifold (2 tubes/well) and 1 x 6-channel aspirate manifold to process 48-well plates.
24-Well	1 x 8-channel dispense manifold (2 tubes/well) and 1 x 4-channel aspirate manifold to process 24-well plates.
12-Well	1 x 9-channel dispense manifold (3 tubes/well) and 1 x 3-channel aspirate manifold to process 12-well plates.
6-Well	1 x 8-channel dispense manifold (4 tubes/well) and 1 x 2-channel aspirate manifold to process 6-well plates.

Waste bottle volume	One 2L vessel; optional accessory includes a waste sensor.
Supply bottle volume	Two 2L plastic bottles (non-autoclavable).

Performance Specifications

Peri-Pump Dispenser

Precision is measured for a whole 96-well or 384-well plate (12- or 24-well plate for RAD technology) using room-temperature deionized or distilled water with 0.1% Tween 20 with FD&C #1 blue dye. Precision is measured for 1536-well plates by dispensing to 384 wells, 12 columns with a 15% isopropyl alcohol solution. The absorbance of the solution is read at 630 nm and 450 nm reference. Specifications apply to volumes that are full unit increments for the cassette to which they apply, except the 1 μL cassette also supports 0.5 μL increments when dispensing this volume. For example: the precision specification for a 10 μL cassette is valid at 10, 20, 30, ..., 3000 μL ; the 1 μL cassette precision specification is valid at 0.5, 1, 2, 3, ..., 30,000 μL .

Accuracy is measured gravimetrically when dispensing room-temperature deionized water. Specifications apply to volumes that are full unit increments for the cassette to which they apply. For example: the accuracy specification for a 10 μL cassette is valid at 10, 20, 30, ... 30,000 μL .

Cassette	Precision	Accuracy
1 μL	10%CV @ 1 μL per well	$\pm 10\%$ @ 1 μL per well
	5%CV @ 2 μL per well*	$\pm 5\%$ @ 2 μL per well*
	10%CV @ 0.5 μL per well	n/a
5 μL	5%CV @ 5 μL per well	$\pm 4\%$ @ 5 μL per well
	2.5%CV @ 10 μL per well*	$\pm 2\%$ @ 10 μL per well*
10 μL	4%CV @ 10 μL per well	$\pm 4\%$ @ 10 μL per well
	2%CV @ 20 μL per well*	$\pm 2\%$ @ 20 μL per well*
* These specifications are for these dispense volumes and higher.		

Exception: the accuracy specs above apply to the RAD technology bulk-dispensing cassette, 8 tubes-to-1 (chute) with 5 μL tubing for volumes that are 8 times the full unit increments for the cassette, e.g. valid at 40, 80, 160, ... 30,000 μL :

- $\pm 4\%$ when volume is 40 $\mu\text{L}/\text{well}$
- $\pm 2\%$ when volume is ≥ 80 $\mu\text{L}/\text{well}$.

Cassette Expected Lifetime

Cassette Types	Cassette Life	Total Volume
1 μ L	1000 384-well plates @ 5 μ L/well	2,000 mL
5 μ L	1000 96-well plates @ 50 μ L/well	5,000 mL
10 μ L	1000 96-well plates @ 100 μ L/well	10,000 mL

With strict adherence to best practices and maintenance recommendations, this is the typical longevity of the dispense cassettes.

Syringe Dispensers

Precision is measured for a whole 96-well or 384-well plate using room-temperature deionized or distilled water with 0.1% Tween 20 with FD&C #1 blue dye. Precision is measured for 1536-well plates by dispensing to 384 wells, 12 columns with a 15% isopropyl alcohol solution. The absorbance of the solution shall be read at 630 nm and 450 nm reference.

Accuracy is measured gravimetrically when dispensing room-temperature deionized water.

Dispense Precision	
8-Tube	\leq 2% CV when dispensing 100 μ L/well \leq 5% CV precision at 20 μ L/well \leq 5% CV precision at 40 μ L/well ** ** Tested in-house to <4.0% CV.
16-Tube	\leq 2% CV when dispensing 100 μ L/well \leq 2.5% CV precision at 80 μ L/well*** \leq 5% CV precision at 20 μ L/well \leq 10% CV precision at 5 μ L/well* *unspecified for non-autoclavable syringe pumps. *** Tested in-house to <1.6% CV.
32-Tube	< 12% CV when dispensing 6 μ L per tube

Dispense Accuracy	
8-Tube	For all volumes 2 μ L or 1%, whichever is greater, at flow rate 2.
16-Tube	For all volumes 2 μ L or 1%, whichever is greater, at flow rate 2.
32-Tube	\pm 5% when dispensing 6 μ L/well at flow rate 3.

Low-Density-Plate-Specific Manifolds

Dispense Precision		
Refer to the values below for dispense precision when measured in full plates with the specified volume of deionized water with 0.1% Tween 20 and FD&C#1 blue dye solution and read at 630 nm/405 nm.		
Plate Type	Performance	Volume ($\mu\text{L}/\text{well}$)
6-Well	$\leq 5.0\%$ CV	5560
12-Well	$\leq 3.0\%$ CV	2240
24-Well	$\leq 3.0\%$ CV	1120
48-Well	$\leq 3.0\%$ CV	560

Dispense Accuracy is measured gravimetrically when dispensing any volume of room-temperature deionized water using [Flow Rate 2](#). For all plate-specific manifolds, dispense accuracy shall be 2 μL or 1%, whichever is greater.

Strip Washer

Residual Volume (Evacuation Efficiency)	
96-Well	Average residual of ≤ 2.0 μL per well after a 3-cycle wash when dispensing 300 μL per well using a bottom-touching well aspiration and a solution of deionized water with 0.1% Tween® 20 or equivalent buffer solution. (The aspirate height adjustment should be optimized for the plate prior to testing.)
6-, 12-, 24-, 48-Well	Refer to the table below to determine the average residual volume per well after dispensing the specified μL -per-well using a bottom-touching well aspiration and a solution of deionized water without Tween in flat-bottomed plates. (The aspirate height adjustment should be optimized for the plate prior to testing.)

Washer Manifold	Volume ($\mu\text{L}/\text{well}$)	Travel Rate	Residual Volume ($\mu\text{L}/\text{well}$)
6-well	5560	0 CW	600
12-well	2240	0 CW	150
24-well	1120	0 CW	50
48-well	560	0 CW	25

Dispense Precision		
Refer to the values below for washer dispense precision when measured in full plates with the specified volume of deionized water with 0.1% Tween 20 and FD&C#1 blue dye solution and read at 630 nm/405 nm.		
Plate Type	Performance	Volume ($\mu\text{L}/\text{well}$)
96-Well	$\leq 3.0\% \text{ CV}$	300
6-Well	$\leq 5.0\% \text{ CV}$	5560
12-Well	$\leq 3.0\% \text{ CV}$	2240
24-Well	$\leq 3.0\% \text{ CV}$	1120
48-Well	$\leq 3.0\% \text{ CV}$	560
384-Well	$\leq 3.0\% \text{ CV}$	80

Dispense Accuracy	
Washer dispense accuracy shall be $\leq \pm 3.0\%$ when deionized water with 0.1% Tween 20 (and FD&C#1 blue dye) solution. The weight of the fluid dispensed shall be measured gravimetrically.	
Plate Type	Volume ($\mu\text{L}/\text{well}$)
96-Well	300
6-Well	1120
12-Well	2240
24-Well	1120
48-Well	560
384-Well	80

Space Requirements

The [Physical Specifications on page 18](#) describe the width (W), depth (D) and height (H) of the base unit of the MultiFlo FX without an external Peri-pump, Syringe dispenser, or Washer installed. Likewise, the space required for the bottles, tubing and power cables is omitted.

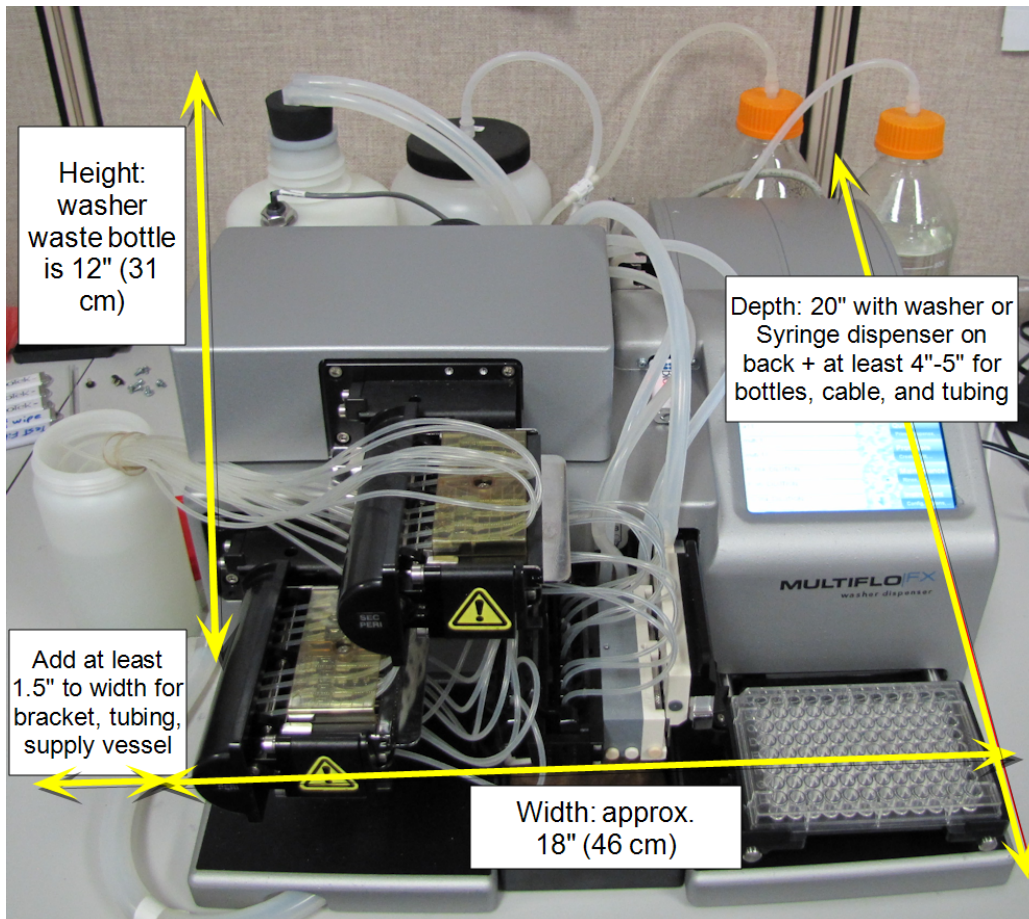

Beginning with the base unit dimensions, add space for accessory devices and vessels:

- Expect a depth of 20" (51 cm) when installing a Strip washer and/or Syringe dispenser to the back. Similarly, expect to add 8" (20 cm) to the depth when installing the RAD technology dispenser.
- Add 4"-5" to the depth or width for fluid supply and waste bottles, depending on placement.
- Plan on a height of approximately 12" (31 cm) when installing the washer: the waste bottle is the tallest accessory, or (if the waste bottle resides elsewhere) at least 10" to accommodate the washer tubing bracket.
- When an external Peri-pump or Syringe dispenser is installed on top, the height increases to about 10", which is required for RAD™ technology.

- Increase the width requirement to include the side tubing bracket and/or supply vessels.
- BioStack integration requires a width of at least 34" in the standard 90° interface. Find more details in the BioStack Operator's Manual.

BioTek's Customer Resource Center

BioTek's Customer Resource Center (CRC) continues our tradition of superior service and support. After an easy registration process, you can access lots of useful information about your BioTek microplate instrumentation and software. On the secure CRC website, you can:

- Track orders
- Access warranty information, user manuals and software updates
- Download technical and application information
- Maintain equipment inventory (product registration)
- Request service and technical support
- View service history
- And much more!

Register at <https://customer.biotek.com>

- Dispense cassette data sheets are available for download at the CRC.

Installation

This chapter provides detailed installation instructions.

Unpack and Inspect the Instrument	28
Install the Waste Tubing	29
Remove the Shipping Hardware	31
Set up the Strip Washer	34
Set Up the Peri-pump Dispenser	44
Install the Secondary Peri-Pump	46
Install RAD Technology Components	51
Install the Syringe Dispenser Component	62
Install Software/Connect to Computer	71
Connect Power Cable	72
Define Instrument Settings	73
Verify Performance	79
Repacking the MultiFlo FX	82
Install the Shipping Hardware	83
Repacking the Secondary Peri-pump	85
MultiFlo FX Repacking	86
Repacking the Syringe Dispenser	89
Repacking the Strip Washer	90

Unpack and Inspect the Instrument

Important: Save all packaging materials. If you need to ship the instrument or accessories to BioTek for repair or replacement, you must use the original packaging. Using other forms of commercially available packaging is not recommended and can void the warranty. Improper packaging that results in damage to the instrument may lead to additional charges. Refer to the operator's manual for repacking instructions.

Inspect the shipping box, packaging, instrument, and accessories for signs of damage.

If the MultiFlo™ FX Multi-Mode Dispenser is damaged, notify the carrier and your BioTek representative. Keep the shipping cartons and packing material for the carrier's inspection. BioTek will arrange for repair or replacement of your instrument immediately, before the shipping-related claim is settled.

1. Unpack the boxes containing the instrument and other equipment:
 - MultiFlo™ FX Multi-Mode Dispenser and accessories
 - Strip Washer and accessories
 - Dual Syringe Dispenser and accessories
 - Additional Peri-pump Dispenser and accessories, including RAD™ technology components, if applicable.
2. Place all packing materials back into the shipping boxes for reuse if necessary.
3. **Syringe Dispenser** models: when the Syringe dispenser is a component of your instrument, review the placement options for it ([as described on page 63](#)) and decide which one best suits your lab before proceeding with the installation.

Refer to the [Package Contents on page 12](#) to make sure you have all expected equipment.

Install the Waste Tubing

A length of tubing and a bracket to hold it is provided to drain the priming trough into a waste container. It's safer to perform this task before removing the shipping hardware.

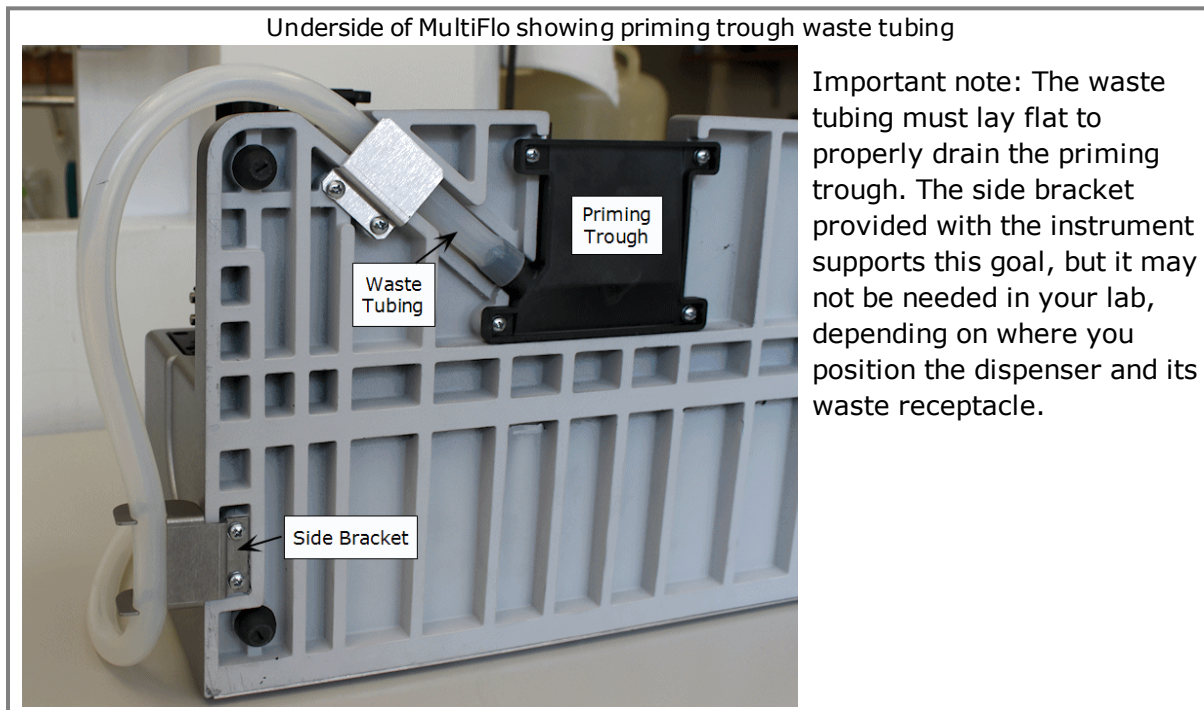

You will need:

- Philips head screwdriver (small)
- Waste tubing: 4' provided (PN 7213010)
- Possibly scissors or knife to cut tubing to desired length
- Side bracket provided
- Waste vessel: to capture discarded fluid

To install the tubing:

Install Side Bracket for Waste Tubing

1. Turn instrument onto its back to access its underside.
2. Remove the two screws in the lower left corner. You will use them to install the bracket.
3. Align the side bracket with the screw holes so its hook opens towards you and use the screws to install the bracket.

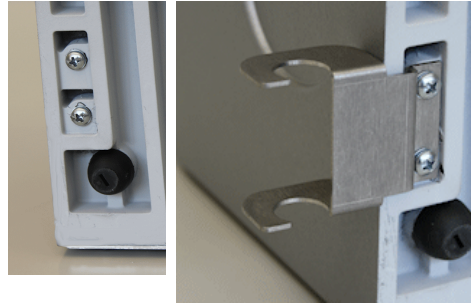

 You may or may not use the side bracket, depending on where you place the waste vessel.

Attach the Tubing to the Priming Trough

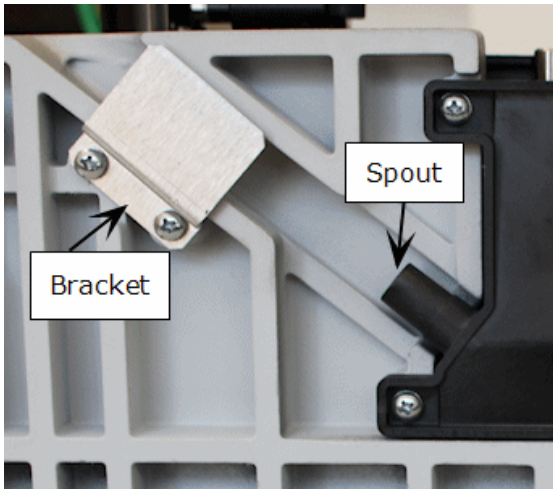

1. Thread the waste tubing under the bracket and onto the priming trough's spout.

 Remove the bracket and/or use water or alcohol to help the tube slide onto the spout.

2. Snake the tubing around the instrument to the side bracket.
3. Return the instrument to normal position.

Position Waste Container and Tubing

When all the installation steps are completed:

1. Place the waste container under the instrument's work surface.
2. Position the waste tubing to drain into the waste container, cutting it to the optimal length, if necessary.

Next, remove the shipping hardware.

Remove the Shipping Hardware

Two shipping brackets (and a rubber band when a Peri-pump is included) protect the MultiFlo FX during shipping. After installing the waste tubing for the priming trough, place it upright on a level work surface to remove the shipping hardware. (Store the shipping brackets on the back of the instrument in slots provided for this purpose.)

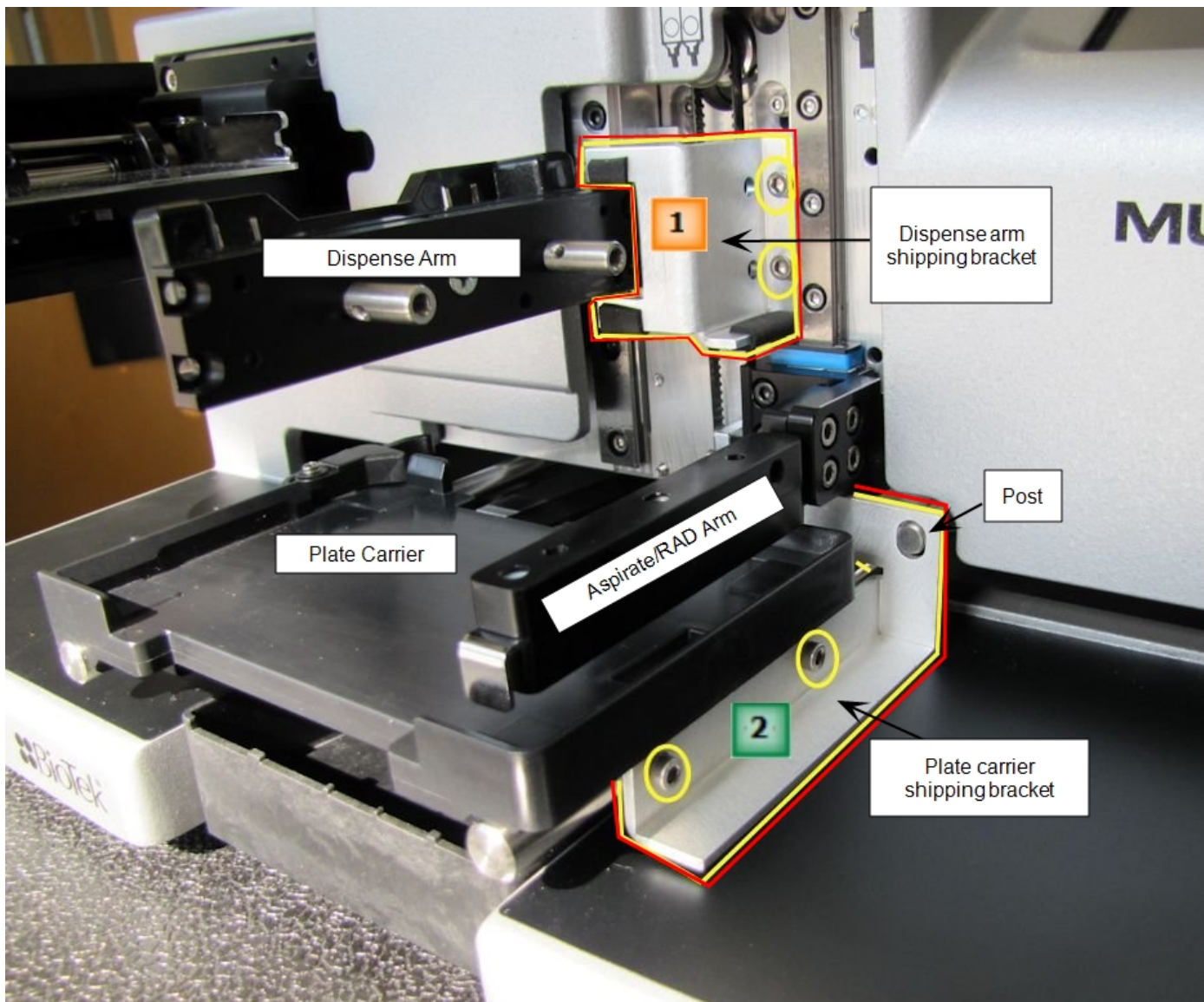

You will need:

- Allen (or hex) wrench taped to plate carrier.

The shipping hardware is slightly different than shown above for MultiFlo FX

without a washer or RAD technology:

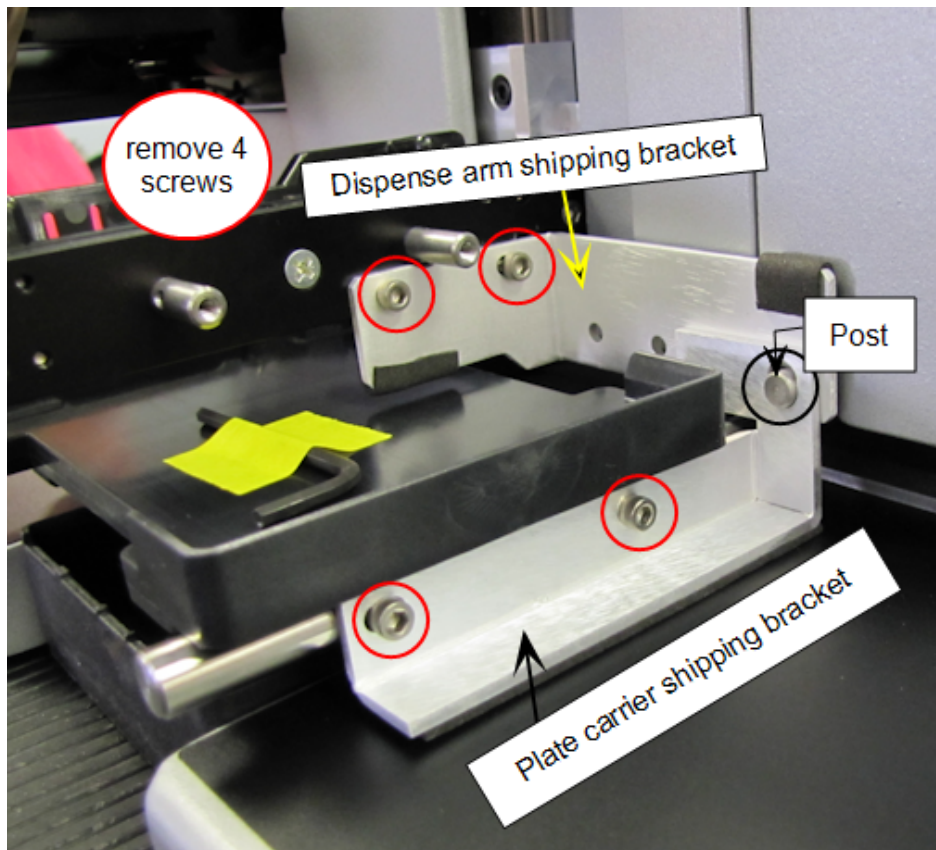

For these MultiFlo FX models:

- MFX
- MFXP

First remove the plate carrier shipping bracket and then remove the dispense arm bracket.

Reverse this order when reinstalling the brackets (before shipping): put the dispense arm bracket on the post first.

Remove shipping brackets:

1. Remove the plate carrier shipping bracket: use the Allen wrench to remove the two screws that hold it to the plate carrier. Tilt the bracket downwards slightly, and release it from the post.
2. Remove the dispense arm shipping bracket: use the Allen wrench to remove the two screws that hold the bracket to the instrument.
3. Attach the shipping brackets to the back of the instrument for storage. They will be needed if the dispenser must be shipped in the future.

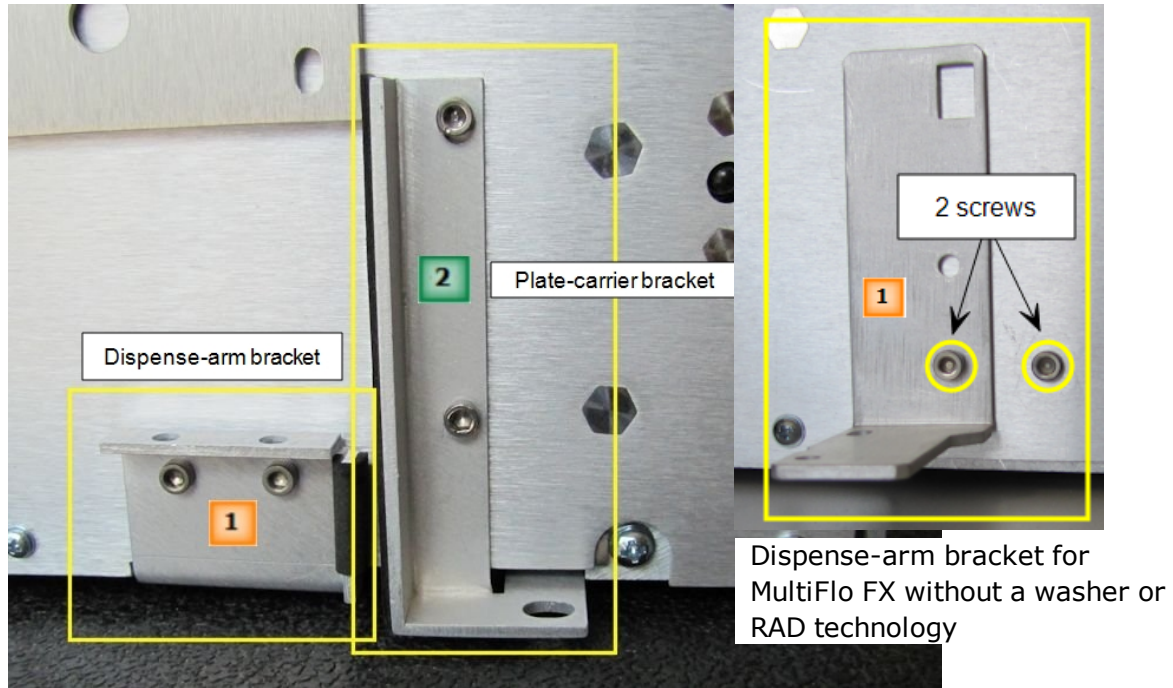

4. Insert the brackets into their respective slots on the back of the instrument, in lower right corner. Slide the plate-carrier bracket's longest arm into the slot and use the Allen wrench to screw it in place. (Exception: The dispense-arm bracket for MFX and MFXP models does not fit into a slot. Attach it with one screw so the short end projects out from the instrument. You must first remove the large support bracket attached to the back panel that is used for an external Peri-pump. Insert the second screw next to the bracket.)

Store the Allen wrench for future use.

Set up the Strip Washer



Perform these steps:

- [Attach washer module and connect its cable on the facing page,](#)
- [Install the tubing bracket on page 37,](#)
- [Install the Fluid Supply on page 38,](#)
- [Install the Waste Bottle on page 39,](#)
- [Install the muffler on page 41,](#)
- [Install Washer Manifolds on page 41.](#)

Strip Washer accessories

Provided with the strip washer module:

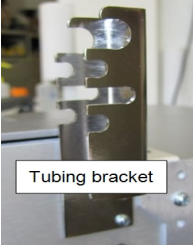
Part	Part Description	Part Number
	<p>Aspirate manifold: install on dedicated aspirate arm. Press the stainless steel tab on the front of the arm to install (and to remove) the manifold.</p> <hr/> <p> Install this manifold last, after installing items on the dispense arm.</p> <hr/> <p>See Install Washer Manifolds on page 41</p>	1260510 for 96/384-well (shown)
	<p>Dispense manifold: install on the dispense arm after installing either the Syringe dispenser manifolds or the spacer block.</p> <div style="border: 1px solid black; padding: 5px; margin-top: 10px;"> <ul style="list-style-type: none"> ■ Several plate-type-specific manifold sets are offered. </div>	1260511 for 96/384-well (shown)

Part	Part Description	Part Number
 <p>A blue plastic muffler with a white base and a clear cap. The label reads: BioTek, Part Number: 4073009.</p>	<p>Muffler: install on exhaust tubing to reduce instrument noise. Finger-tighten only.</p>	4073009
 <p>A grey rectangular block with three circular holes along its length.</p>	<p>Spacer block: to properly position washer manifolds when the dual Syringe dispenser is not installed. Put the spacer on the dispense arm before installing the washer dispense manifold (in lieu of Syringe dispenser manifolds).</p>	1260522
 <p>Two small metal thumb screws with knurled heads.</p>	<p>Thumb screws: to secure dispense manifold to dispense arm. Especially useful when performing magnetic bead assays. See Special Procedure for Magnetic Bead Assays on page 151.</p>	01262
 <p>A metal bracket with three circular openings for tubing. A label at the bottom reads "Tubing bracket".</p>	<p>Tubing bracket: to hold tubing in place.</p>	1262066
 <p>A white circular filter with a central hole. The text around the edge reads: INLET 1.0 µm PTFE, L89480085, W147448.</p>	<p>Vacuum Line Filter: cut the vacuum line tubing and install the filter to prevent contaminants from clogging the vacuum pump.</p>	48146

[See also Strip Washer Optional Accessories on page 15](#) for part numbers for plate-type-specific washer manifolds.

Attach washer module and connect its cable

The MultiFlo FX's optional strip washer is positioned on posts and attached to the back of the instrument. A bracket holds the fluid supply and waste tubing, keeping

the tubing secure and away from moving parts.

You need a Philips screwdriver.

1. First, remove the screws and washers that will attach the washer to the back panel.
2. Align the slots on the side of the washer module with the two posts near the base. Simultaneously, align the screw holes on the top of washer unit.
3. Use the screws removed in the first step to attach the module to the instrument.
4. Connect the serial cable from the washer module to its port on the back of the instrument.

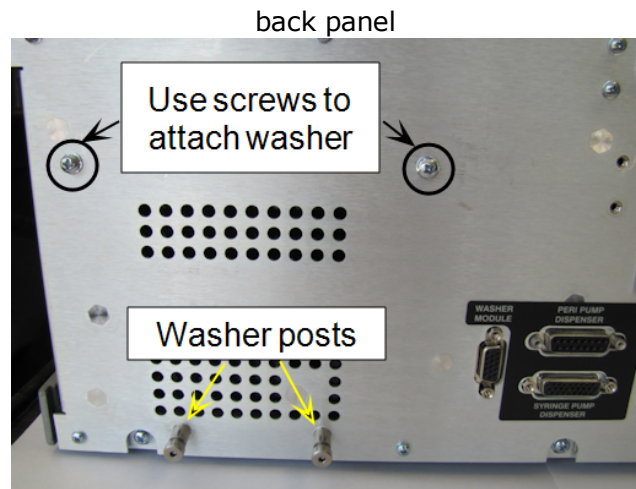

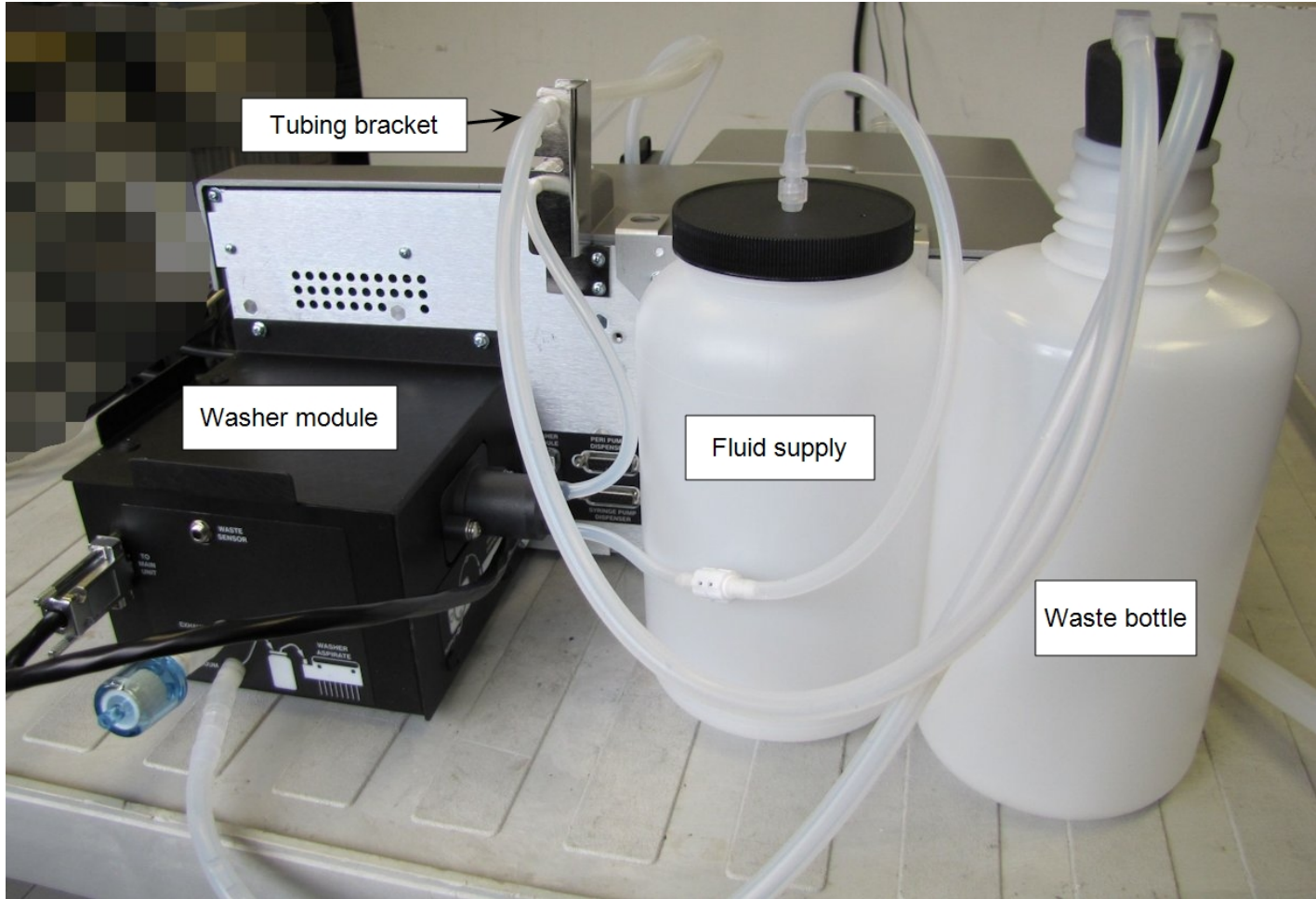

The washer module functions as a shelf for a Syringe dispenser, if desired.

Install the tubing bracket

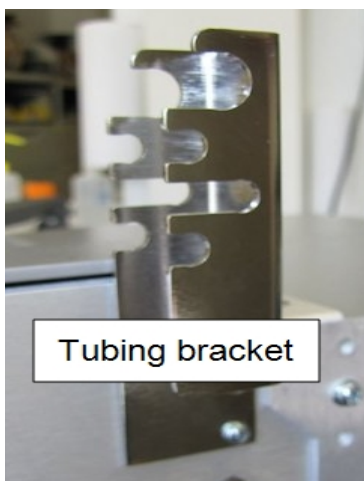

A stainless steel bracket to keep the tubing away from moving devices is provided with the washer and RAD models.

Attach the bracket to the back of the instrument: near the top, center of the instrument, slightly left of the aluminum mounting plate as you face the back panel.

You need a small Philips screwdriver.

1. First, remove the two screws you will use to attach the bracket. Refer to the photo below to locate the screws on the back of the instrument.
2. Align the bracket to the holes and use the screws to attach it.

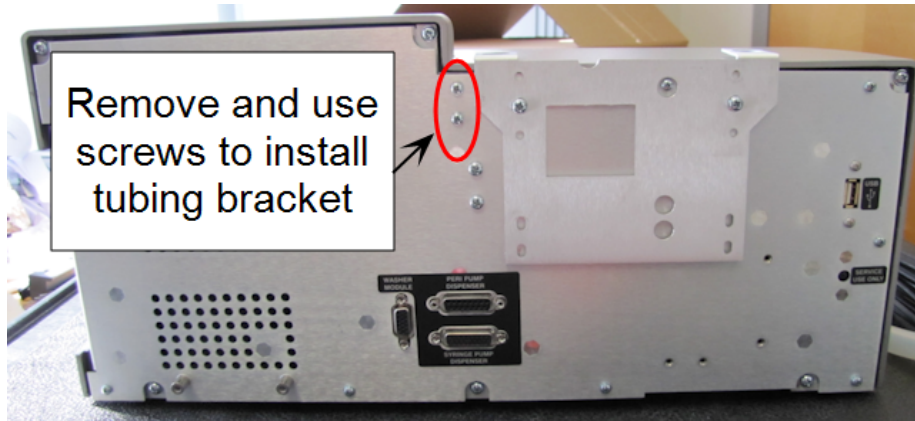

The tubing bracket is designed to snugly hold the check valves of the fluid supply tubing and the waste tubing's rigid valve.

Install the Fluid Supply

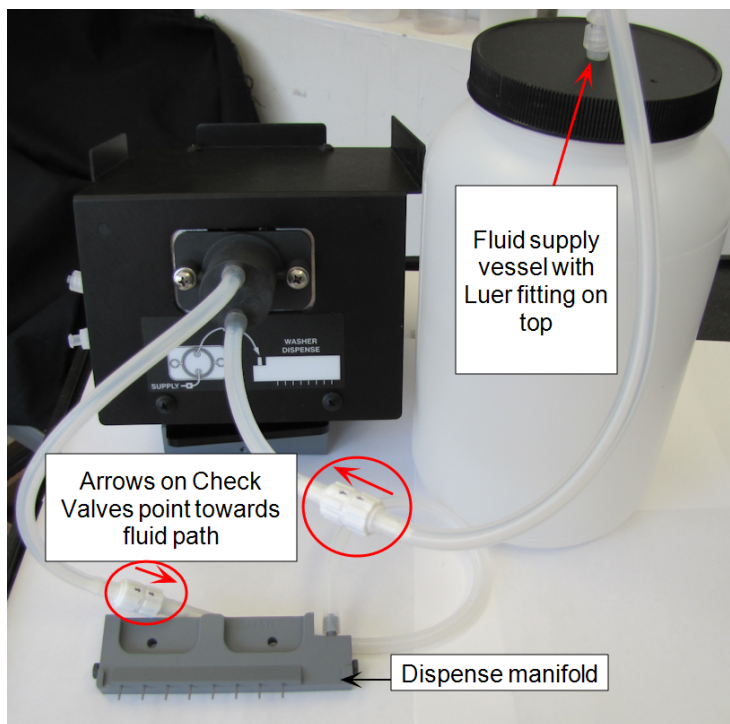

The strip washer's fluid supply system (PN 1263007) uses a two-liter plastic supply vessel and two tubes with check valves, powered by a non-autoclavable syringe pump.

1. Locate the tubing with the Luer fitting on one end. Gently screw the Luer fitting into its connection on the top of the supply bottle. Finger-tighten only.
2. Attach the other end of the fluid supply tubing to the **bottom port** of the washer pump. Make sure the arrow on the check valve points towards the pump.
3. Connect the tube without fittings to the **top port** of the washer pump. Make

- sure the arrow on the check valve points away from the pump.
4. Connect the other end of the tube to the dispense manifold.



Fluid supply installed

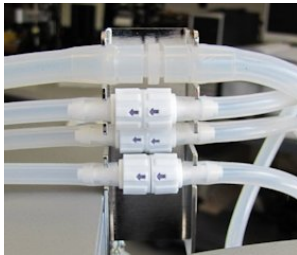

When you're ready, snake the tubing from the devices mounted on the back of the instrument to the manifolds on the front: put the supply tubing check valves and the rigid fixture of the waste tube in the center of the bracket.

As part of the setup: [Install Washer Manifolds on page 41.](#)

Install the Waste Bottle

The washer collects waste fluid during aspiration. The waste bottle is connected to the vacuum pump (inside the washer module) and the aspirate manifold to perform this function.

An inline vacuum filter (not shown) is optional but strongly recommended because (1) the filter prevents waste material aerosols from being released into the air, and

(2) the filter serves as a temporary fluid barrier in the event that the waste bottle is allowed to overflow. (The filter part number is 48146.)

An optional Waste Sensor bottle, PN 4070545, alerts users to the need to empty the waste container, preventing overflow problems.

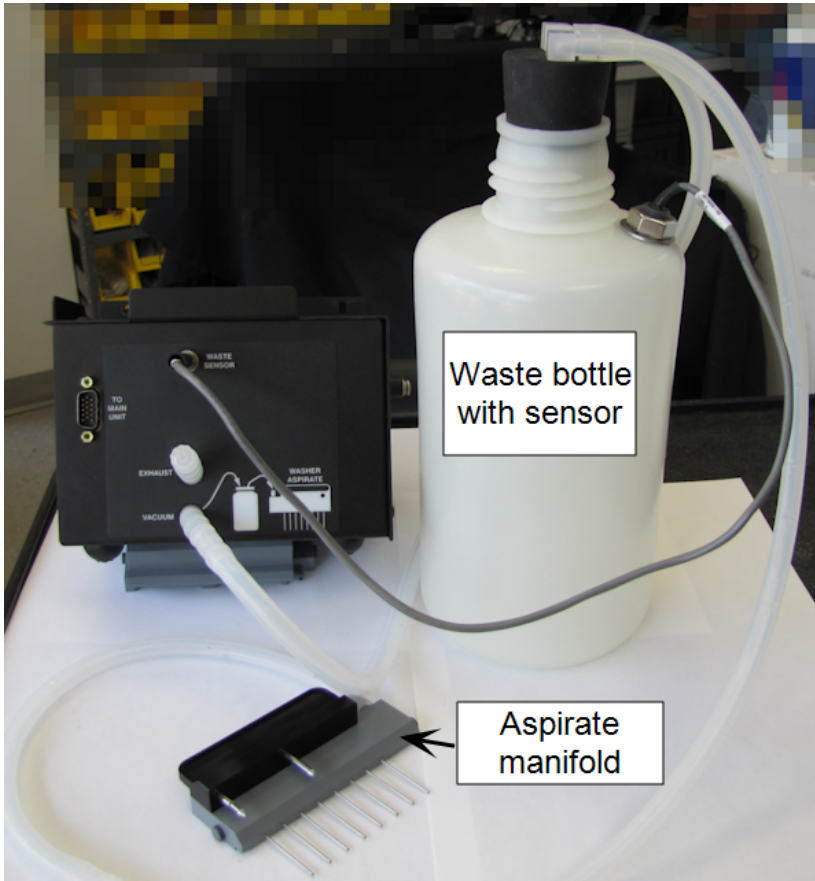

1. Remove the waste bottle cap and replace it with the stopper from the waste tubing set (PN 1263001).
2. Connect the tube without a fitting to the aspirate manifold.
3. Install the inline vacuum filter on the tubing with a Luer fitting:
 - Cut the tubing about two inches from the Luer fitting,
 - insert the filter to reconnect the tubing.
4. Gently screw on the Luer fitting to the port labeled **Vacuum**.
5. If applicable, connect the waste sensor cable to the **Waste Sensor** port and enable the sensor:

Using the Touch screen	Using the LHC
1. Select Instrument>Washer .	1. Select Tools>Instrument

Using the Touch screen	Using the LHC
<ol style="list-style-type: none"> 2. Touch the field to enable Waste detection under Sensors Enabled. 3. Press the Home button. 	<p>Utilities.</p> <ol style="list-style-type: none"> 2. Under Strip Washer, fill the checkbox to enable Waste Detection. 3. Click Send, and then, Exit.

Install the muffler



Install the optional vacuum pump muffler (PN 4073009) to reduce noise during operation: Connect the muffler's Luer fitting to the **Exhaust** port. Finger tighten, only.

Install Washer Manifolds

The strip washer has two distinct manifolds: the dispense manifold resides on the dispense arm, along with the Peri-pump cassette's Tip Holder and the dual Syringe dispensers manifolds, if equipped. The aspirate manifold resides on its own dedicated aspirate arm.

Important: Either the dual Syringe dispenser manifolds or the spacer block must be installed on the dispense arm **before** the washer dispense manifold can be installed. And, the washer dispense manifold must be installed **before** the aspirate manifold is installed.

1. Turn off the MultiFlo FX, if necessary.
2. Connect the fluid supply tubing to the dispense manifold.

[Install the Fluid Supply on page 38](#)

[Install the Waste Bottle on page 39](#)

3. Connect the waste vessel tubing to the aspirate manifold.
4. Lower the aspirate arm to gain access to the dispense arm, if necessary, i.e. move it out of the way.
5. First, install either the Syringe dispenser manifolds or the spacer block on the dispense arm:
 - orient the block so its lip points down and abuts the dispense manifold;
 - position the Syringe manifold's tubing closest to the instrument.

Typically, magnets hold them securely.

6. With its supply tube closest to the instrument, guide the dispense manifold onto the dispense arm. Its magnet will hold it securely. Alternatively, especially when running magnetic bead assays, remove the magnet and use the thumb screws provided. [Special Procedure for Magnetic Bead Assays on page 151.](#)
7. Lift the aspirate arm to its highest position. Align the two pins on the aspirate manifold with the holes on top of the arm, and press the "**Aspirate arm release tab**" to install the aspirate manifold.

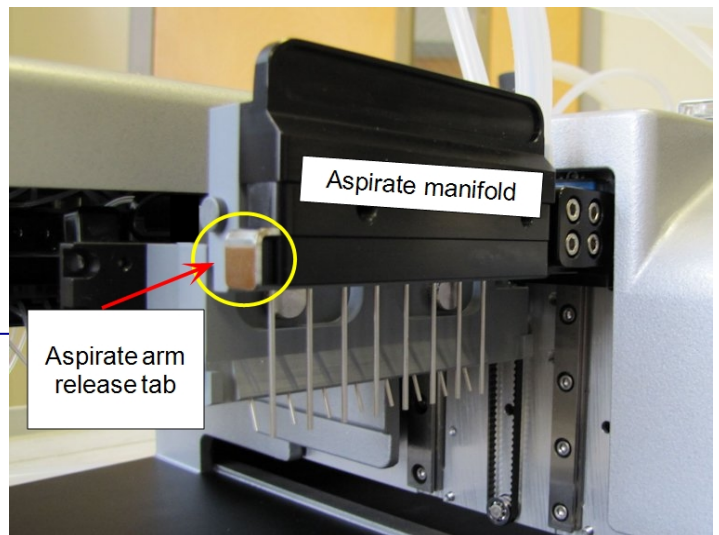
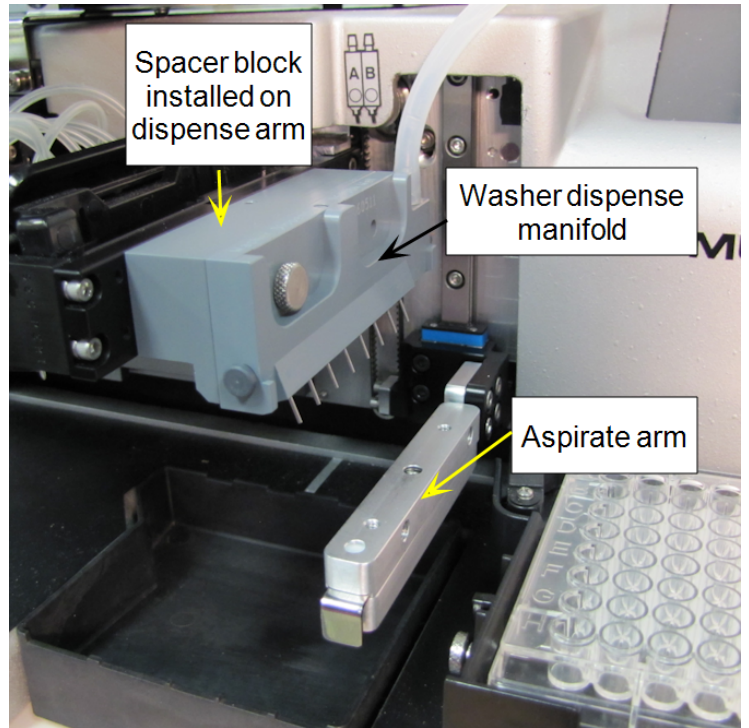

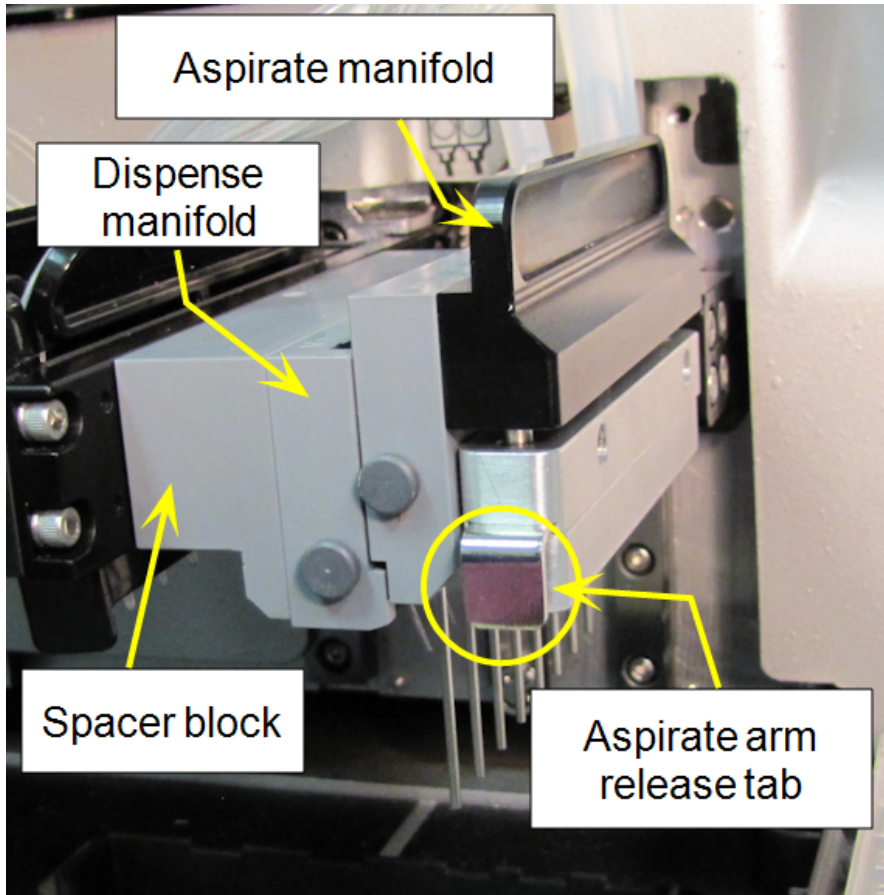

Install the **Syringe Dispenser** manifolds on the dispense arm instead of the "Spacer block," if applicable.

To remove the washer manifolds:

Reverse the order of the installation steps, i.e. first remove the aspirate manifold: press the release tab. Then, remove the dispense manifolds.

Set Up the Peri-pump Dispenser

Install these items to use the Peri-pump dispenser:

- [Install the external Peri-pump](#), if applicable
- [Install RAD Technology Components](#)
- Or, [attach the Peri-pump cover panel](#)
- [Dispense cassette](#)
- [Fluid supply vessel](#)
- (Optional) [Prime trough insert](#)

Attach the Peri-pump Cover Panel

Optionally, if you are **not** installing an external (or secondary) Peri-pump, install the cover panel provided to conceal the primary Peri-pump.

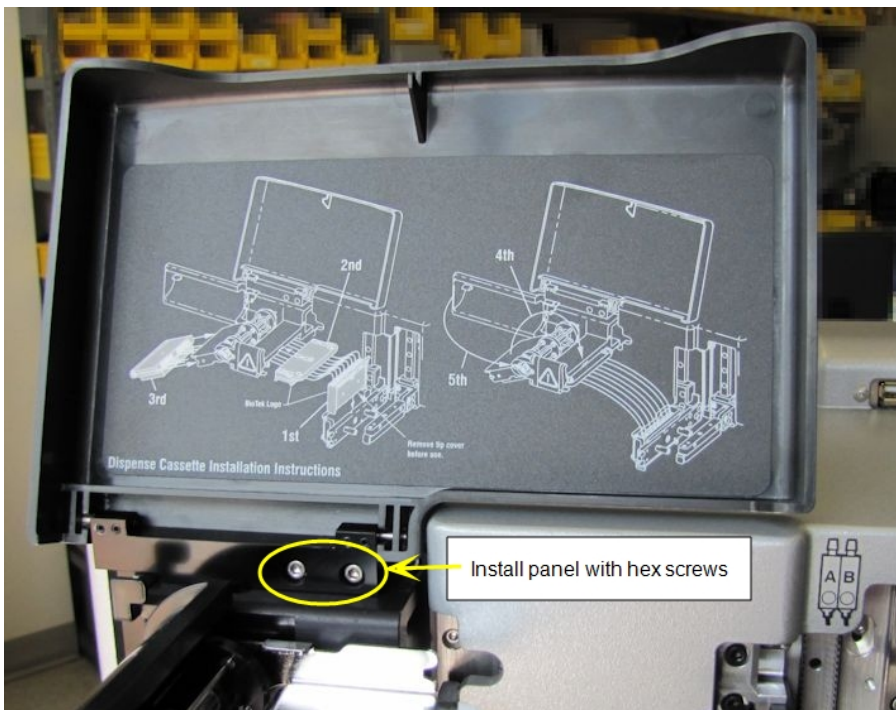

Install the cover panel using the two hex screws and the Allen wrench shipped with the MultiFlo FX.

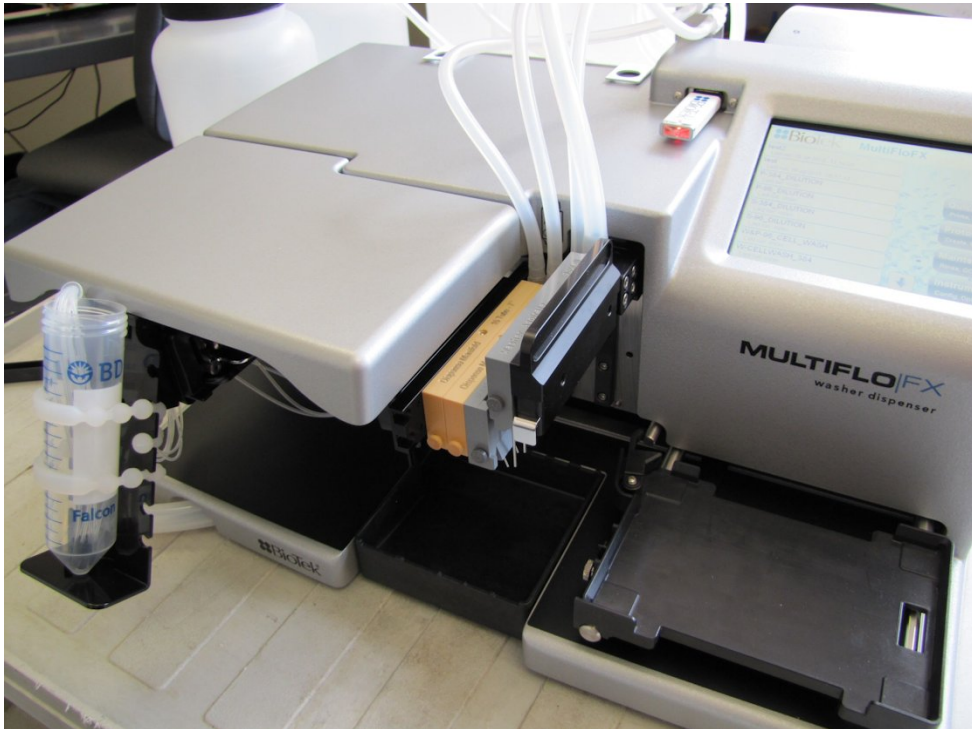

MultiFlo FX with closed Peri-pump cover panel

Install the Secondary Peri-Pump

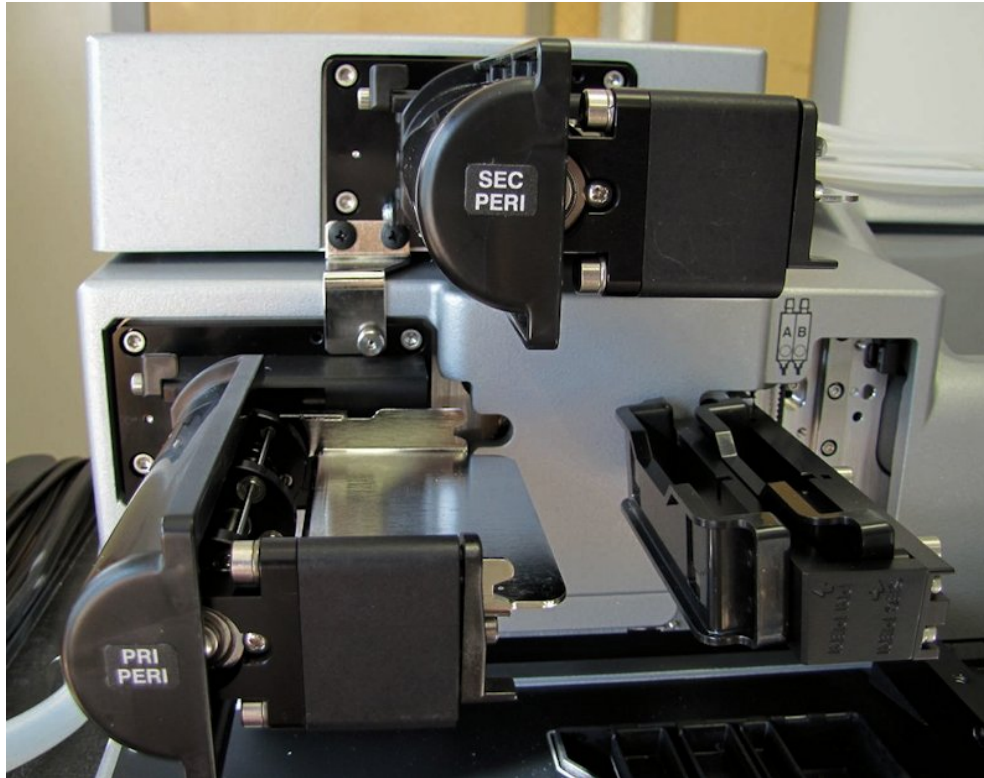

An optional secondary or external Peri-pump dispenser is available for the MultiFlo FX. It ships as a kit with its own accessories and it is required for [RAD™ technology](#). Inspect and unpack the shipping container and follow these installation instructions if applicable. Otherwise, skip this part of the installation process.

The secondary Peri-pump is designed to sit on top of the MultiFlo FX, above and slightly right of the internal Peri-pump.

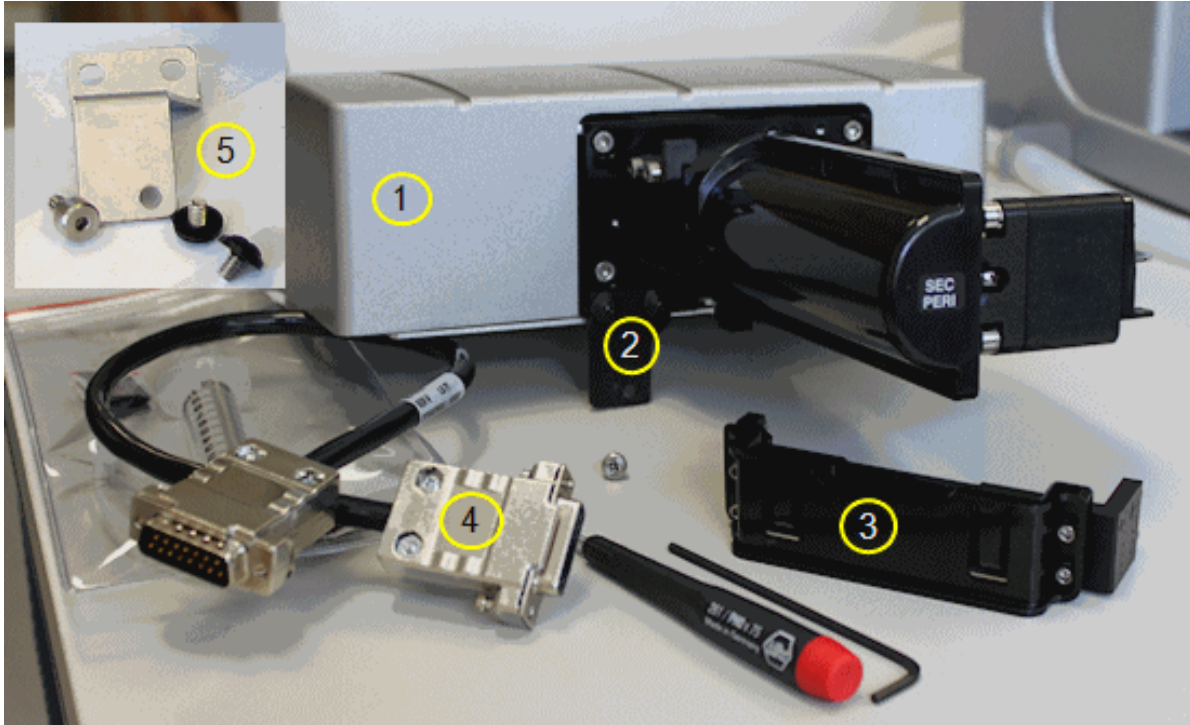

Kit components include:

- 1 - additional Peri-pump
- 2 - small tab to secure unit to the instrument
- 3 - additional dispense cassette bracket
- 4 - interface cable to connect unit to the instrument
- 5 - MultiFlo FX Only: extra stainless-steel bracket to replace #2
- Also note the screwdriver, Allen (hex) wrench, and shoulder screw shipped with the accessories.

You will need:

- Second Peri-pump Kit components (shown above)
- Philips head screwdriver (small)
- Small flat screwdriver

Install the additional Peri-pump:

MultiFlo FX ONLY: Change the bracket on the front of the Secondary Peri-pump unit:

- Remove the black plastic tab and replace it with the stainless-steel bracket shipped in the kit, using the same screws. (See #5 above.)

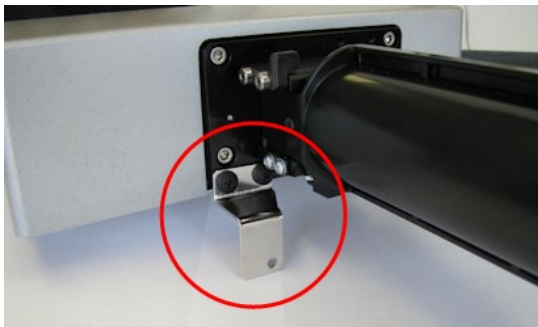

1. First, remove the support bracket stored on the back of the instrument. It will be used to secure the dispenser on top of the instrument. Remove the two screws holding the bracket in place.

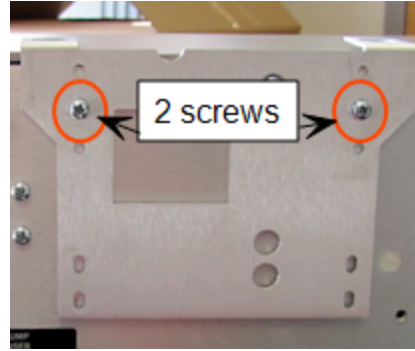

2. Two more screws needed for the installation are shipped on the back of the Peri-pump unit. Remove the two screws and keep with the bracket.

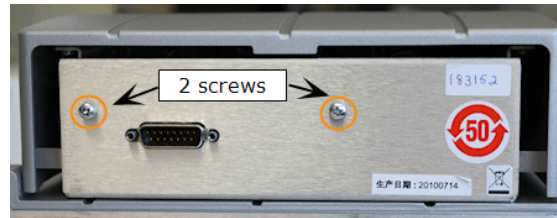

3. Place the second Peri-pump unit on top of the dispenser.

4. Position the dispenser so the screw hole in the small tab or stainless-steel bracket attached to its front aligns with the right-hand screw hole on the primary Peri-pump or cover plate.

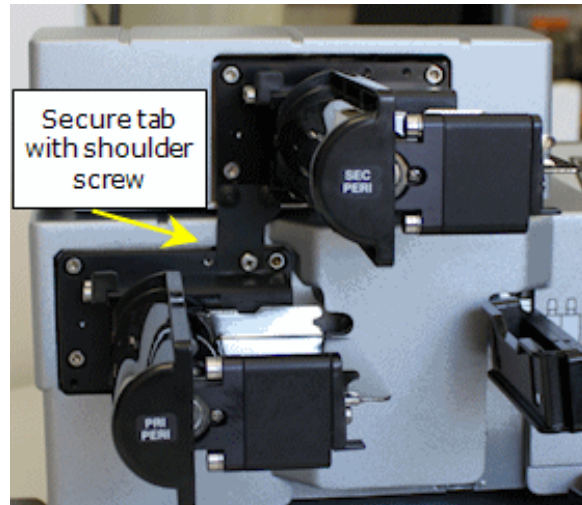

5. Use the Philips screwdriver to fully tighten the shoulder screw to ensure the unit is secured.

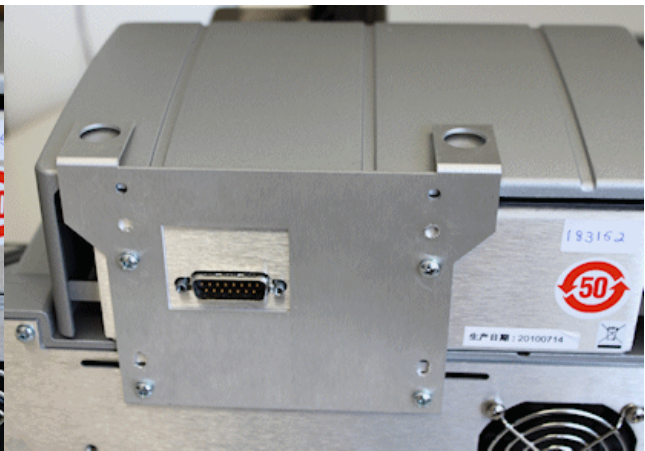
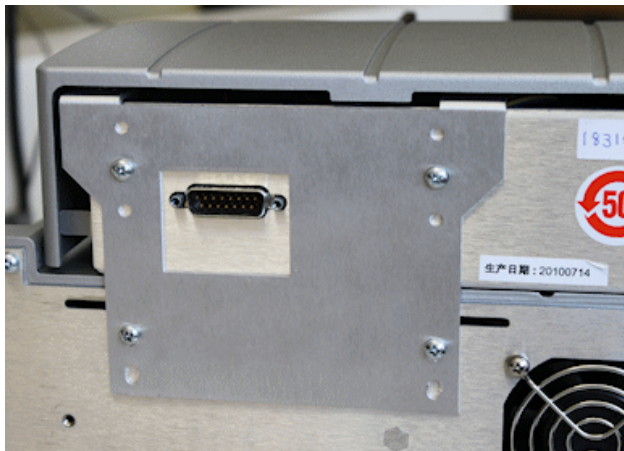

6. On the back of the instrument, secure the Peri-pump unit in place

The support bracket can be installed two ways, to provide foot holds for a Syringe dispenser module, or not.

with the support bracket and the four screws removed from the instrument earlier. Partially tighten the screws until all 4 are in place, then tighten all the screws.

Hide the bracket's foot holds inside the case when a Syringe dispenser will not be installed on top of the second Peri-Pump.

Install the additional dispense cassette bracket:

 This task is easier to perform when the cassette bracket is well lit. It's a tight space and the second cassette bracket fits snugly onto the original bracket.

1. First, remove the four screws and washers from the additional cassette bracket using the small Allen wrench supplied in the kit.
2. Slide the plate carrier to the left, out of the way. Lower the dispense arm to a workable position.
3. Use the text on the front of the additional cassette bracket to orient it correctly and place it around the original bracket.
4. Use the four screws to secure the bracket over the existing bracket. Place and partially tighten the screws until all four are in place, then tighten all the screws.

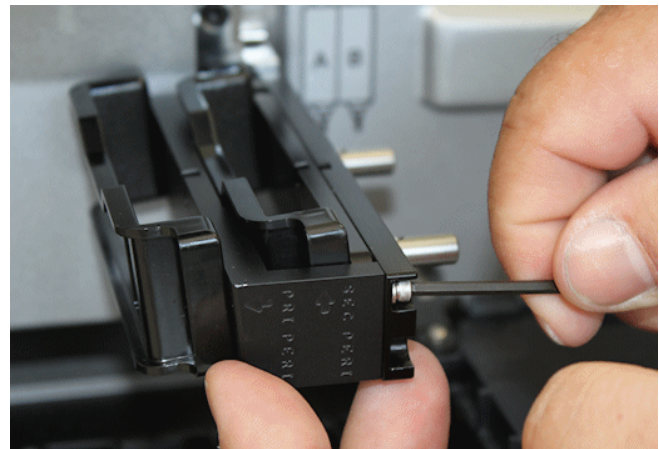

Install cable to connect the dispenser:

1. On the back of the instrument, connect the interface cable to the **Peri-pump Dispenser** port on the back of the instrument and to the port on the back of the Peri-pump unit. Use the small flat screwdriver to secure the cable.



- If you are installing a Syringe dispenser also, you may find it easier to complete that installation before connecting the cable, turning on the instrument, and installing the dispense cassettes.

Install RAD Technology Components

Perform these installation steps for the RAD technology Peri-pump dispenser, if applicable. Otherwise, skip this section.

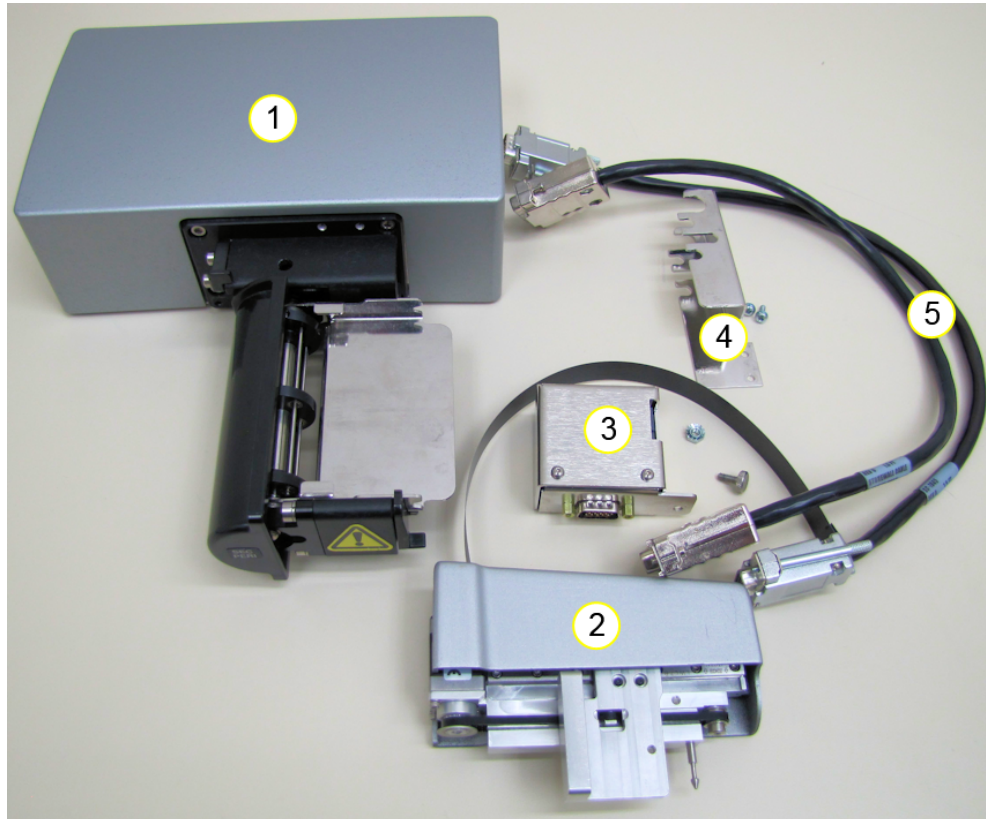

RAD™ Technology Components

- 1** - Secondary or external Peri-pump
- 2** - RAD dispense head (with ribbon cable)
- 3** - RAD module and thumbscrew
- 4** - Tubing bracket
- 5** - Cables (2)

RAD technology uses the secondary or external Peri-pump dispenser, a tubing bracket, and a dedicated dispense head. After removing and storing the shipping hardware, install these components:

- [Install the Secondary Peri-Pump on page 46](#)
- [Install the Tubing Bracket and RAD Module below](#)
- [RAD: Plug in the cables on page 53](#)
- [Install RAD Dispense Head on page 53](#)
- [Install RAD Technology Cassette on page 58](#)

Install the Tubing Bracket and RAD Module

First, install the tubing bracket and then attach the small RAD module with a serial port to the bracket.

Install the tubing bracket

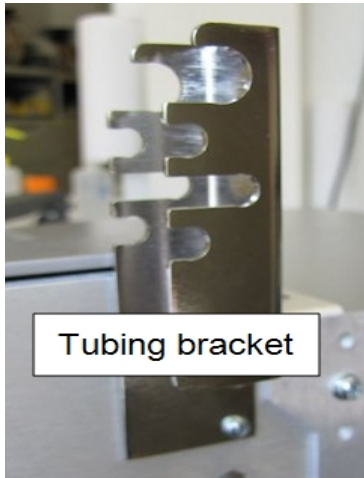

A stainless steel bracket to keep the tubing away from moving devices is provided with the washer and RAD models.

Attach the bracket to the back of the instrument: near the top, center of the instrument, slightly left of the aluminum mounting plate as you face the back panel.

You need a small Philips screwdriver.

1. First, remove the two screws you will use to attach the bracket. Refer to the photo below to locate the screws on the back of the instrument.
2. Align the bracket to the holes and use the screws to attach it.

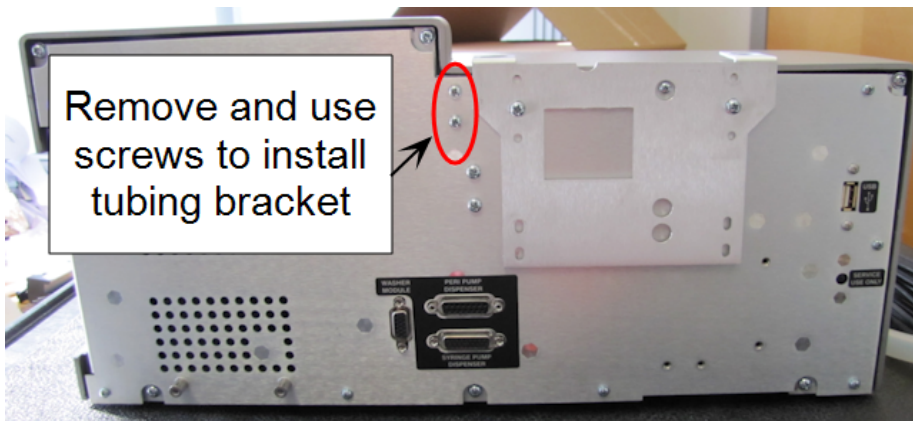

Attach the RAD Module to the Tubing Bracket

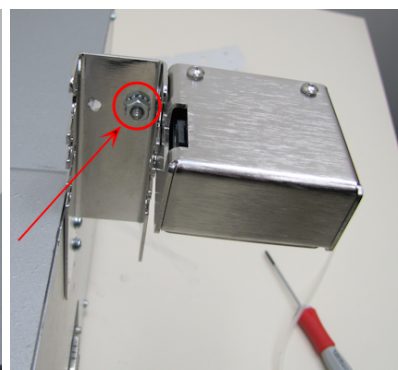
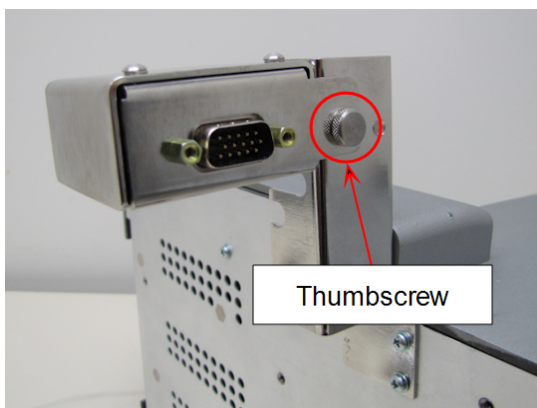

View of inside the tubing bracket

1. First, remove the thumbscrew and bolt shipped on the tubing bracket.
2. Use the thumbscrew to attach the RAD module to the tubing bracket.

RAD: Plug in the cables

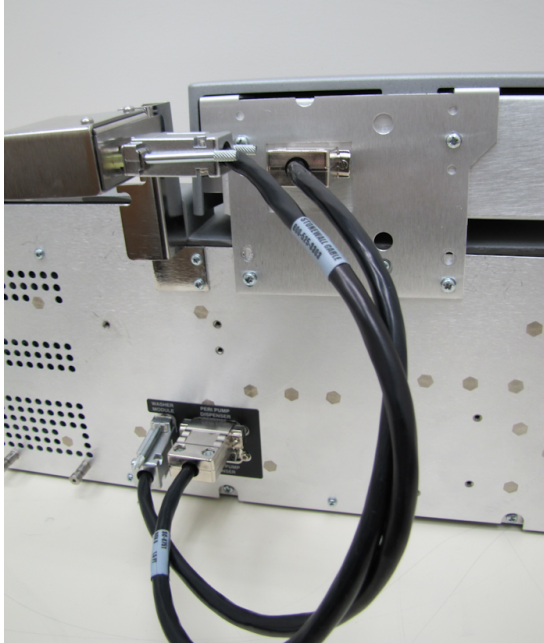

Plug the cables into their respective ports:

- RAD module to **Washer Module** port
- Peri-pump to **Peri-Pump Dispenser** port

Install RAD Dispense Head

The RAD dispense head resides on the dedicated Aspirate manifold/RAD arm. Its ribbon cable plugs into the RAD module (installed in earlier step).

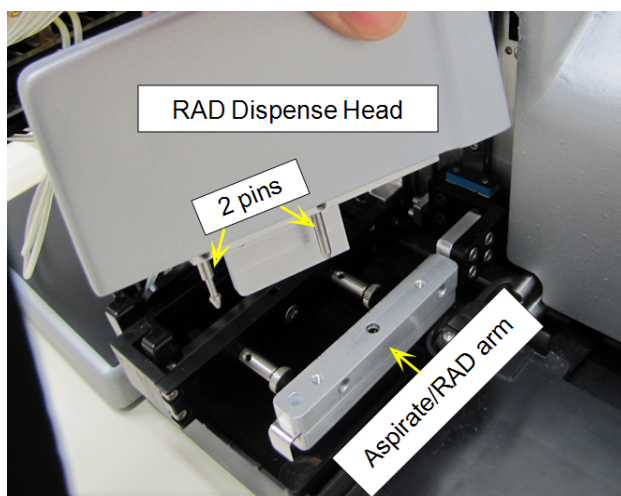

1. Align the two pins on the dispense head with the two holes on the RAD arm, and press the **Release Tab** (on the front of the arm) to install the dispense head.

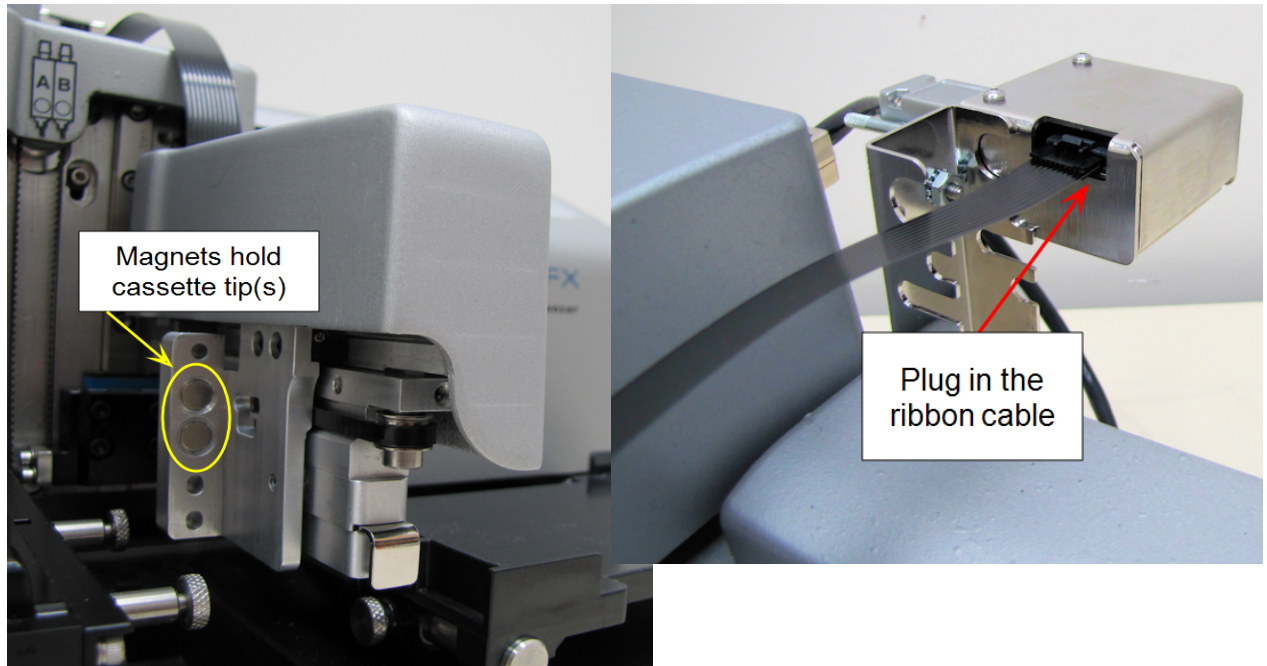

2. Plug the ribbon cable on the dispense head into the RAD module (installed on the tubing bracket).

Next, install the RAD cassette: [Install RAD Technology Cassette on page 58](#).

Dispense Cassette Diagram

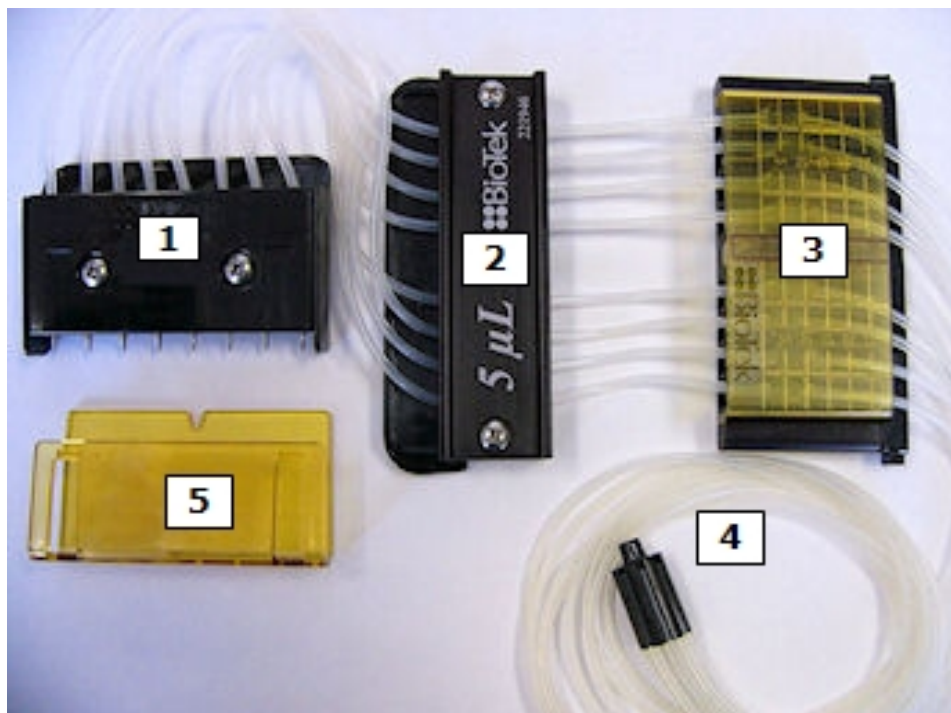

- 1 - Tip Holder
- 2 - Center Holder
- 3 - Tube Tensioner
- 4 - Tubing Organizer
- 5 - Tip Guard
(remove before use)

Tubing Cassette Diagram



RAD™ Technology tips replace #1 Tip Holder when installing the cassette.

1. **Tip Holder:** The cassette's easiest part to identify, the tip holder fits into the dispense arm to the right of the pump for positioning above the plate. Except RAD technology cassette tips fit into a dedicated dispense arm.
2. **Center Holder:** The center holder is labeled to identify the size of the cassette tubing. It also has a serial number for tracking purposes. It slides into grooves on the underside of the pump.
3. **Tube Tensioner:** The transparent 5-mm scale on its front surface identifies the tube tensioner. It has internal screws for stretching the tubing, one for each tube. The tube tensioner's scale is useful when calibrating the cassette.
4. **Tube Organizer:** At the opposite end of the cassette from the tip holder, the tube organizer holds the 8 tubes together for inserting into the fluid vessel. Except it is omitted from the single-tube cassettes.
5. **Tip Guard:** **Remove** the tip guard before installing the cassette. The tip guard protects the tips during shipping. It is not a permanent part of the cassette. The RAD single-tube cassette also ships with a tip guard.

Install the Dispense Cassette

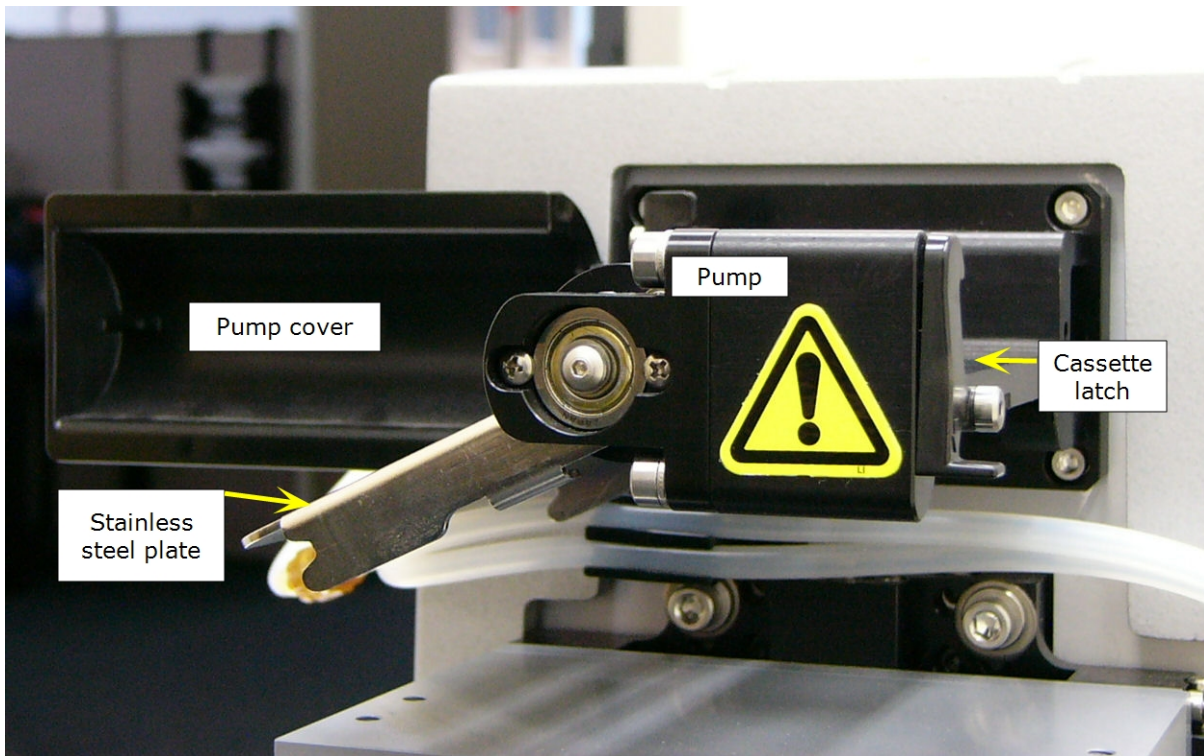

Prerequisites:

- Review the [Dispense Cassette Diagram on page 54](#) to learn the names of the components.
- Move the **Pump Cover** away from the pump to its **OFF** position.
- When you have two Peri-pumps installed, put the Primary pump's Tip Holder in the left bracket and the Secondary pump's Tip Holder in the right bracket.
- Release the pump's stainless steel plate: Use your right hand to release the spring-loaded cassette latch (on the right side of the caution symbol on the pump) and use your left hand to lift the stainless steel plate up and out.



The BioTek logo on the Tip Holder faces the Peri-pump. The logo on the Center Holder faces down, away from the pump.

Note: See [Install RAD Technology Cassette on page 58](#) for single-tube and bulk cassette instructions.

- Slide the **Tip Holder** into the dispense arm. The Tip Holder's front plate with the BioTek logo or steel plate faces the pump. Make sure the tip holder is level and snapped into place.
 - Two Peri-pumps: use left bracket for Primary, right bracket for Secondary.
 - RAD technology** exception: attach the tip holder to the dedicated [dispense head](#).

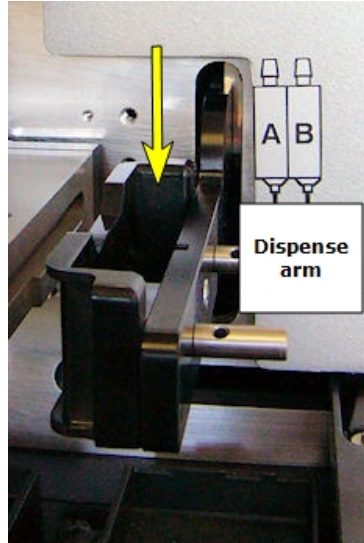

- Extend the rest of the cassette under the Peri-pump, so you can slide the **Center Holder** into its slot on the underside of the pump. A tab on the back of the center holder fits into a notch on the pump. The label on the center holder faces down.



- Align the **Tube Tensioner** with the stainless steel plate as it wraps around and up against the pump. Be sure the knobs on top of the tensioner fit correctly into the grooves in the stainless steel plate as you move both parts up and around the pump and click the steel plate into place.



- Return the Pump Cover to its **RUN** position covering the pump.
- Lift the **Tube Organizer** over the pump cover. Place it in the fluid vessel, when you're ready.

Install RAD Technology Cassette

RAD technology's single-tube and 8-to-1 bulk dispensing cassettes are installed like standard cassettes with one difference, the tip holder is installed on the dedicated RAD dispense head. Install the RAD cassettes on the external or secondary Peri-pump **only!** They are not designed for use on an internal Peri-pump.

Follow instructions to [Install the Dispense Cassette on page 56](#) skipping the first step.

Magnets on the dispense head hold the cassette tip(s) in place:

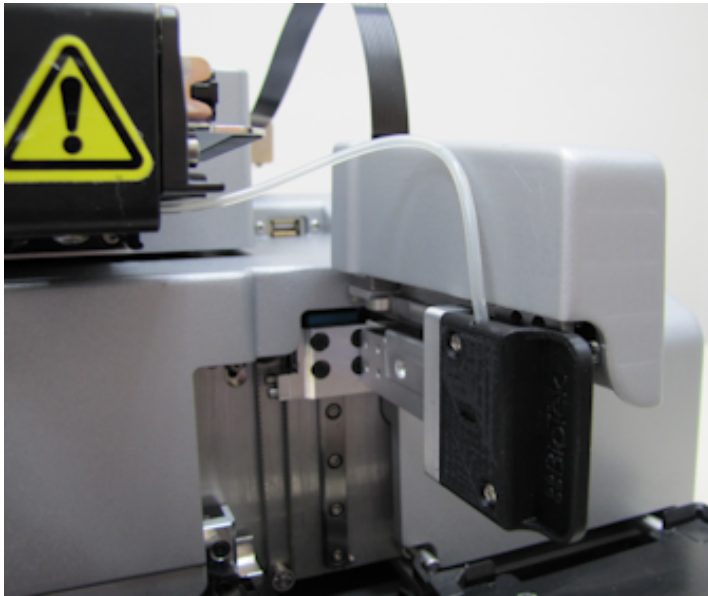

Single tube RAD cassette

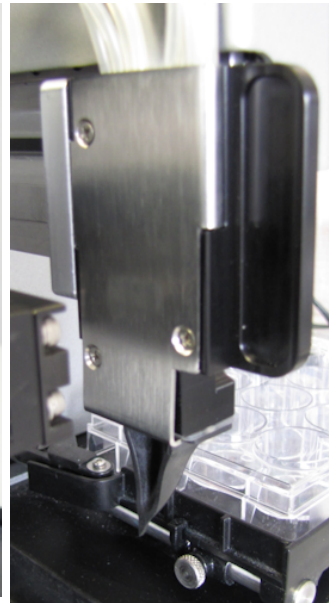

8-tube-to-1 Bulk RAD cassette

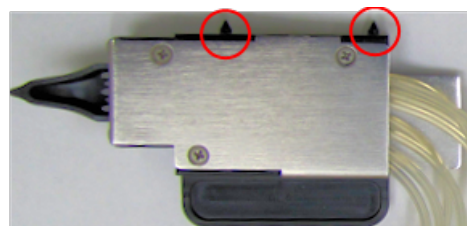
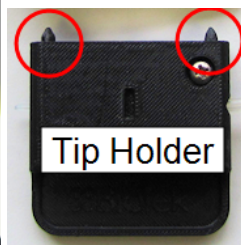
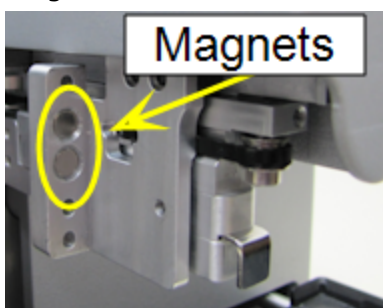

Align the two pins with the holes (above and below the magnets) on the dispense head.

- You must create a protocol to successfully use the RAD 8-to-1 bulk-dispensing cassette. It is not compatible with Quick Dispense.

Prime Trough Inserts

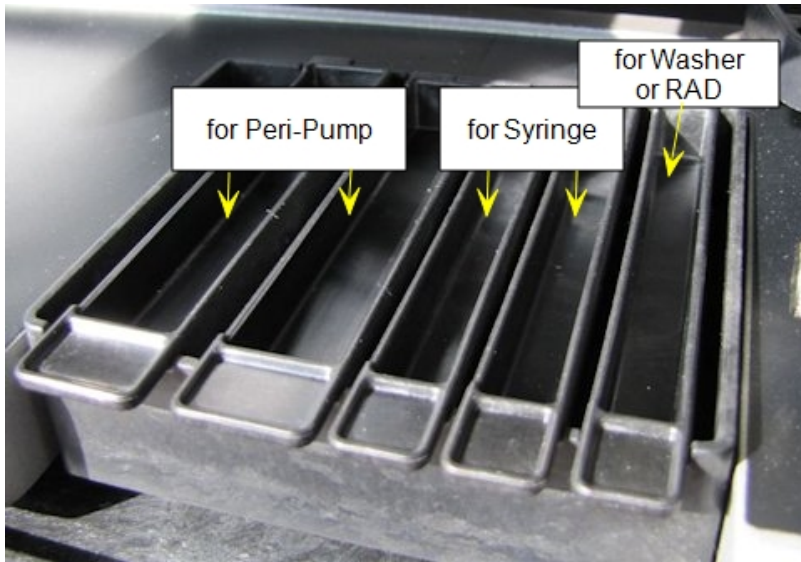

The MultiFlo FX ships with special reservoirs that fit into the dispensers' priming trough to capture expensive reagent after priming, rather than discarding it.

Three types of Prime Trough Inserts may be provided:

- PN 7182043 for the Peri-pump dispenser, holds approximately 12 mL (1 per dispenser)
- PN 7182044: 2 for the Syringe dispensers, 1 for the washer, holds approximately 6.5 mL

■ Without the prime trough insert, the priming trough empties into the regular waste bottle.



Important: Remove the priming trough inserts when using the 8-to-1 RAD cassette. The chute will collide with both the RAD priming cup and the Syringe dispenser insert if they are left in the priming trough.

Peri-pump Reservoir Holder

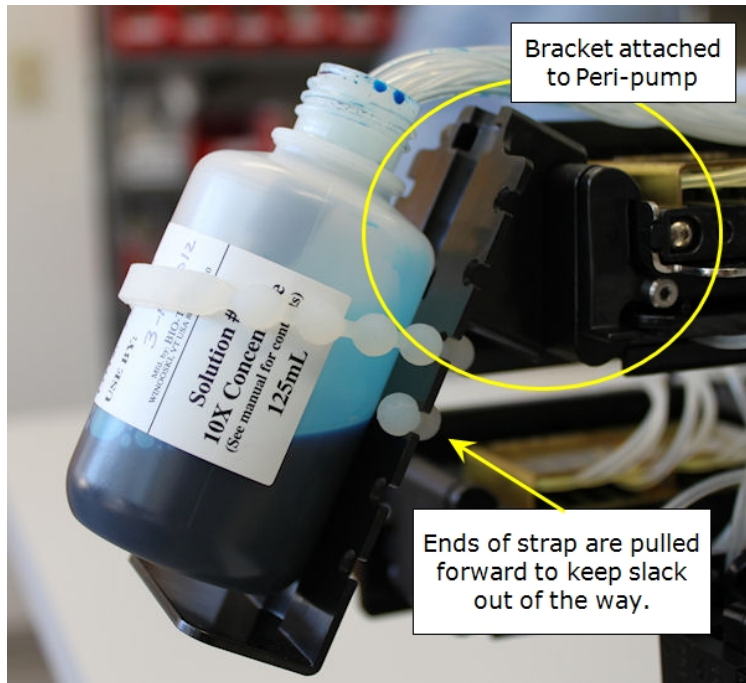

Peri-pump Reservoir Holder attached to Peri-pump

The reservoir holder has two components, a bracket and a strap.

1. Clip the bracket onto the front of the Peri-pump. When properly installed the bracket hides the hazard label.
2. Place the supply vessel (reservoir) on the bracket and wrap the strap around both the vessel and the bracket: fit the strap's molded balls into the round slots.



Depending on the size of the vessel, it may be necessary to tuck the ends of the strap into the bracket, too, to keep the slack out of the way.

- Important: Always remove the tubing from the fluid before releasing the tension on the cassette or changing cassettes.

MultiFlo FX models with a Peri-pump dispenser include the convenient Peri-pump reservoir holder (PN 7210509). The simple bracket clips onto the front of the Peri-pump to hold a variety of vessels.

You can significantly reduce the dead volume, saving precious fluid, by cutting the cassette tubing to make a shorter fluid path. [See Shorten the Dispense Cassette Tubing on the facing page.](#)

Shorten the Dispense Cassette Tubing

Shortening the fluid path reduces the dead volume when dispensing, which helps preserve expensive reagents. BioTek offers the [Peri-pump Reservoir Holder on the previous page](#) as an accessory to the Peri-pump dispenser for this purpose. The cassette tubing can be shortened by as much as 12 inches (30.48 cm) when using the reservoir holder.

Tube Organizer

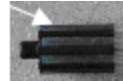

Recommendations for cutting the tubing:

- Prepare a clean, lint-free work area to lay out the cassette;
- Remove the **Tube Organizer** (not applicable to RAD single-channel cassette);
- Use a ruler as a guide to determine where to cut the tubing;
- Cut one tube at a time using a razor blade, Exacto[®] knife, or sharp scissors; make as clean a cut as possible;
- Cut the tubing as evenly as possible, limiting the difference between the tubes to less than 1/4" (6.35 mm) (not applicable to RAD single-channel cassette).



To may make this job easier, use the cassette's packaging to hold the cassette parts, keeping them out of your way.

Dead Volume Reduction: If you cut the Peri-pump tubing (and use the reservoir holder), you can reduce the dead volume:

Standard and RAD 8-to-1 Cassettes

Cassette	Std length tubing	Cut tubing by 12"
1 uL	1.20 mL	0.96 mL
5 uL	4.23 mL	3.38 mL
10 uL	7.36 mL	5.89 mL

RAD Single-tube Cassettes

Cassette	Std length tubing	Cut tubing by 12"
1 μ L	150 μ L	90 μ L
5 μ L	530 μ L	320 μ L
10 μ L	920 μ L	555 μ L

Install the Syringe Dispenser Component

The Syringe dispenser is an optional component and ships separately. Inspect and unpack the shipping container. Skip this part of the installation process if it is not applicable.

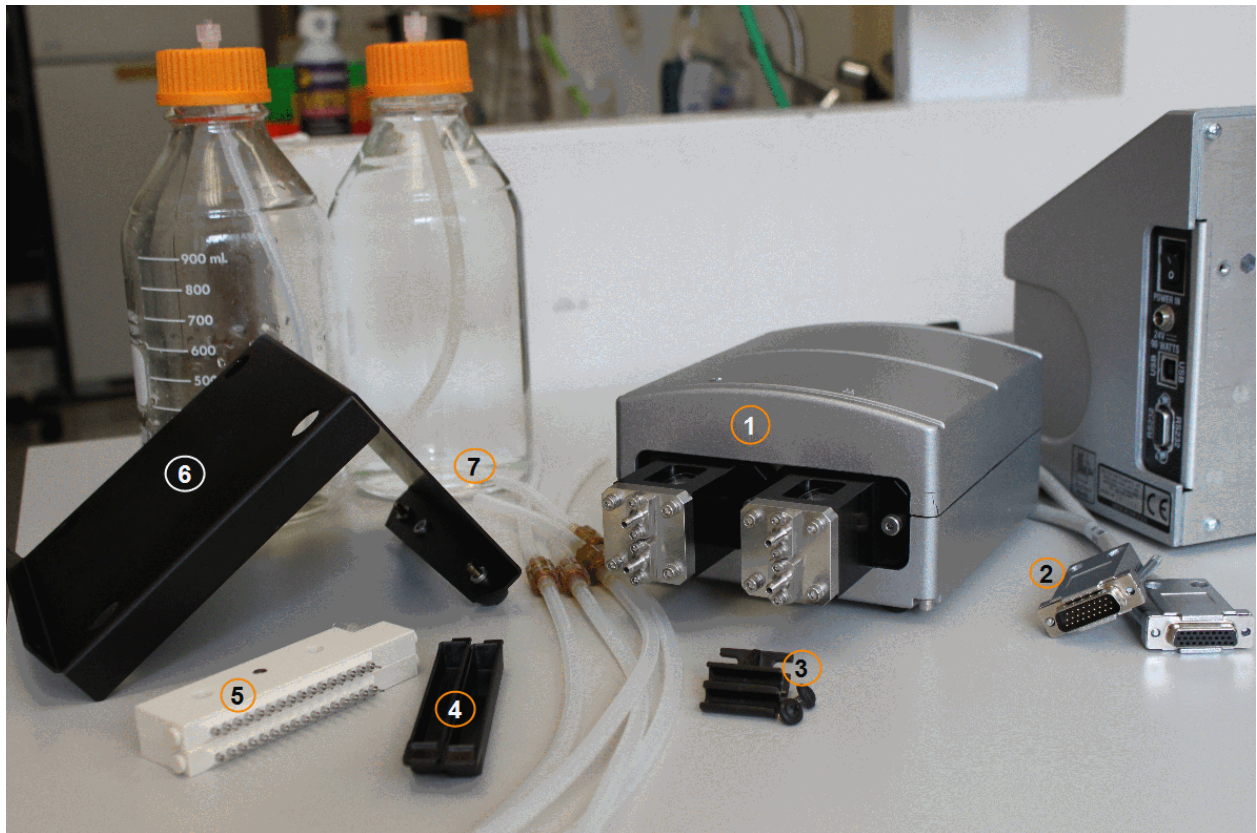

- 1 - Syringe Dispenser module (autoclavable)
- 2 - interface cable
- 3 - tubing bracket
- 4 - priming trough inserts
- 5 - dispense manifolds
- 6 - shelf
- 7 - supply bottles and tubing with check valves
- Not shown: thumbscrews (2) and a USB flash drive.

Review the placement options for the Syringe dispenser and follow the applicable instructions:

[Syringe Dispenser Placement Options on the facing page](#)

Syringe Dispenser Placement Options

There are two major placement options for the dual Syringe dispenser module. First, behind the instrument on a shelf provided for the purpose or similarly, on top of the washer module. The second option is on top of the instrument, itself.

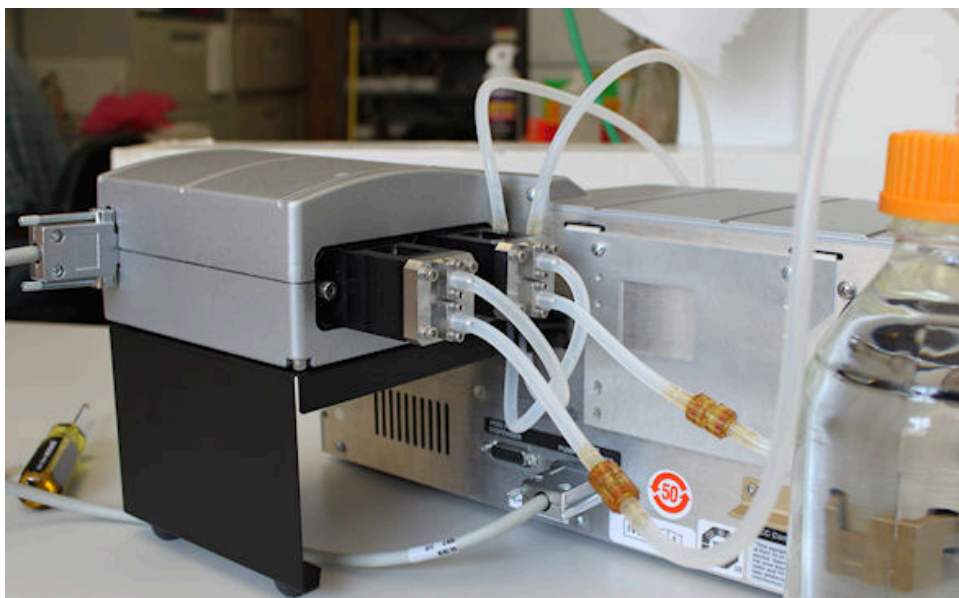

[Install the Syringe Dispenser on Back Shelf on the next page](#) (or on top of the washer)

When installing the Syringe dispenser on top, placement of the tubing bracket varies slightly depending on how many other dispensers are installed.

Follow the installation instructions for your preferred placement of the dispenser:



[Install the Syringe Dispenser on Top on page 65](#)

Install the Syringe Dispenser on Back Shelf

Follow these instructions to install the dual Syringe Dispenser module on a shelf attached to the back of the MultiFlo FX or on top of the washer module.

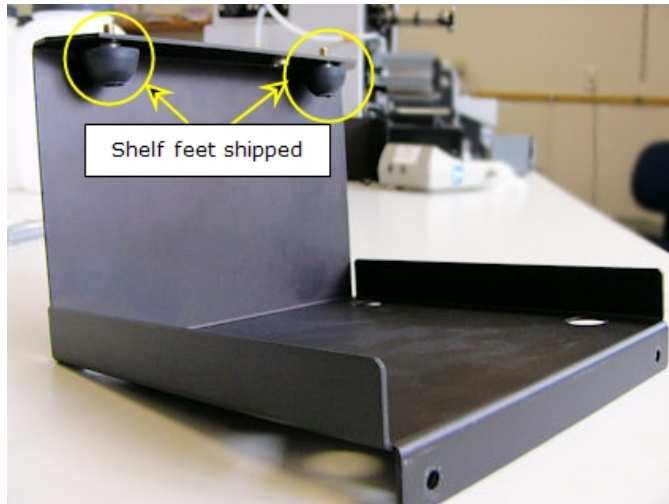

MultiFlo FX Only: The washer module functions as a shelf for the syringe dispenser: skip this step, and use the washer as a shelf, if applicable.

First, reposition the shelf's feet:

1. Remove the shelf shipped with the Syringe dispenser from its plastic bag (PN 7212038).
2. Unscrew the rubber feet that are shipped in the wrong position.
3. Install the feet in the correct position: screw the feet into the two outer holes on the bottom of the shelf. (The third hole is for BioStack integration.)
4. Remove the two screws on the left side of the back of the instrument.
5. Use the screws to install the shelf.

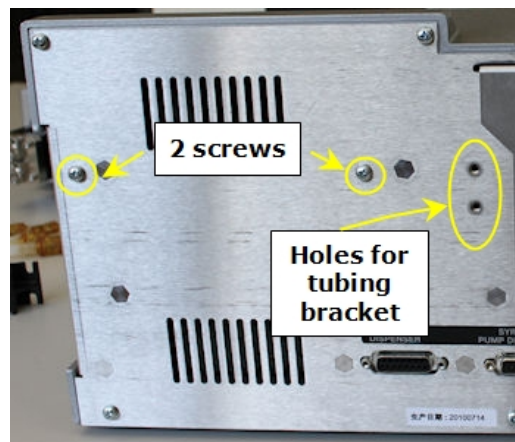
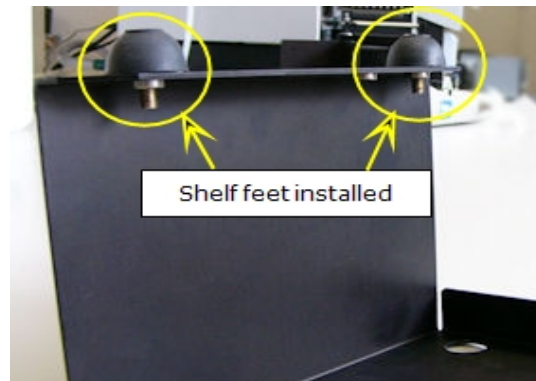



Note: For MultiFlo FX washer or RAD models, use the stainless steel tubing bracket rather than the black plastic bracket provided with the Syringe dispenser.

6. Install the tubing bracket (using the black-capped screws) in the two holes next to the shelf. First insert the bottom screw part way. Position the bracket over the screw and tighten both screws.



7. Put the syringe pump module on the shelf or the washer module.
8. Plug the serial cable into the back panel of the MultiFlo FX in the port labeled **Syringe Pump Dispenser**. Plug the other end into the syringe pump unit.

Next steps:

- [Update the instrument to use the Syringe Dispenser on page 74](#)
- [Install Tubing and Manifolds for Syringe Dispenser on page 68](#)

Install the Syringe Dispenser on Top

Follow these instructions to install the dual Syringe dispenser module on top of the instrument.

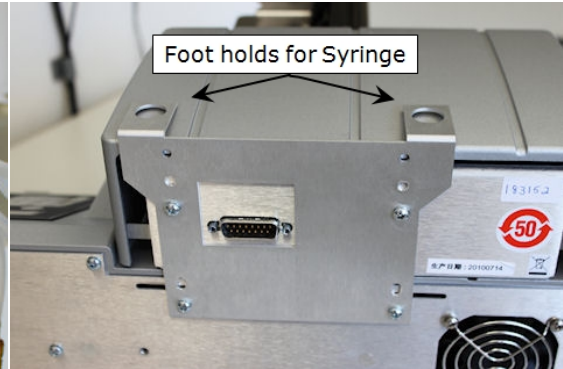
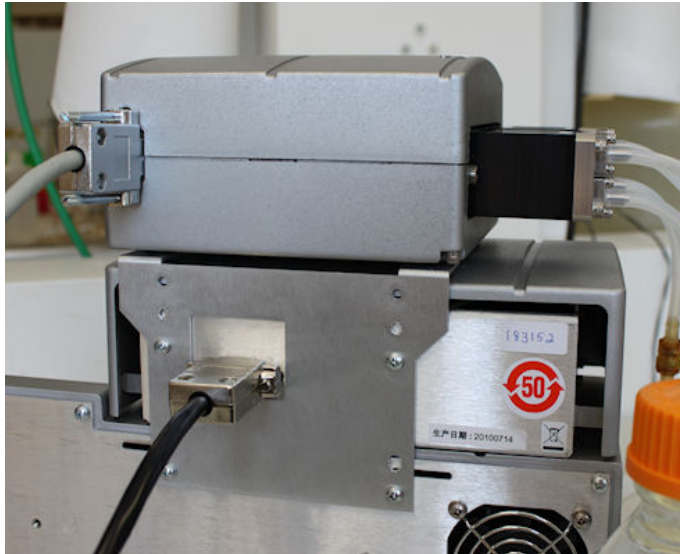

Support bracket with foot holds for the Syringe dispenser.

Syringe dispenser on top of secondary Peri-pump

The MultiFlo FX ships with a support bracket attached to the back of the instrument. The support bracket has foot holds for the Syringe dispenser. The bracket's flexible design supports either one or two devices, the secondary Peri-pump and the Syringe dispenser, alone or in combination.

1. Remove the support bracket from the back of the instrument by releasing the two screws that hold it in place.
2. Align the bracket with the screw holes on the back of the instrument so that the foot holds sit above the instrument or second Peri-pump's top.
3. Install the tubing bracket in the appropriate location using the two black-capped screws:



Tubing Bracket

When installing the Syringe dispenser on top of the instrument, the placement of the tubing bracket varies slightly depending on how many other dispensers are installed. Always position the bracket as close as possible to the syringe pump unit.

1 Peri-pump:

Install the bracket using the two empty screw holes on top of the Peri-pump.

2 Peri-pumps:

Install the bracket using the screw holes on top of the **secondary** Peri-pump, the pump closest to the Syringe.

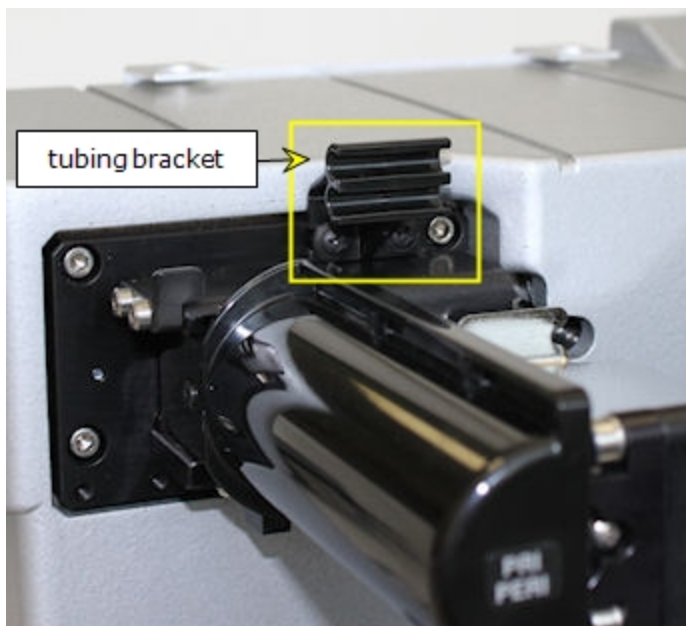
**Syringe Only**

(no Peri-pump)

Remove the two screws in the filler plate on the front of the instrument and replace them with the tubing bracket.

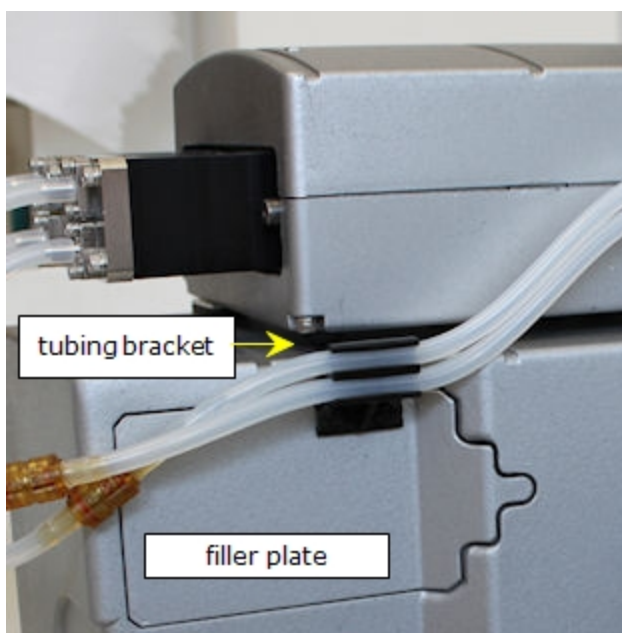

4. Plug the 26-pin high-density cable into the back panel of the MultiFlo FX in the port labeled **Syringe Pump Dispenser**. Plug the other end into the syringe pump unit.

Next steps:

- [Update the instrument to use the Syringe Dispenser on page 74](#)
- [Install Tubing and Manifolds for Syringe Dispenser on the next page](#)

Install Tubing and Manifolds for Syringe Dispenser

For each dispense pump, a set of two tubes with check valves and two supply bottles are provided. The 32-tube dispense manifolds also ship with an optional inline filter.

■ The supply bottles have Luer fittings. Finger-tighten only!

- Place the supply bottles on the same horizontal plane as the instrument. This ensures optimum pump performance.
- Make sure the tubing is not crimped during installation.

Perform these steps twice, first for Syringe A and then for Syringe B:

1. First install the inline filter for 32-tube dispensers, if applicable, ([as described on page 71](#)). Locate the tubing with a Luer fitting on one end. Gently screw the Luer fitting into the top of the supply bottle. Finger-tighten only.
2. Attach the other end of the tubing from the supply bottle to the **bottom port** of one of the Syringe pumps.

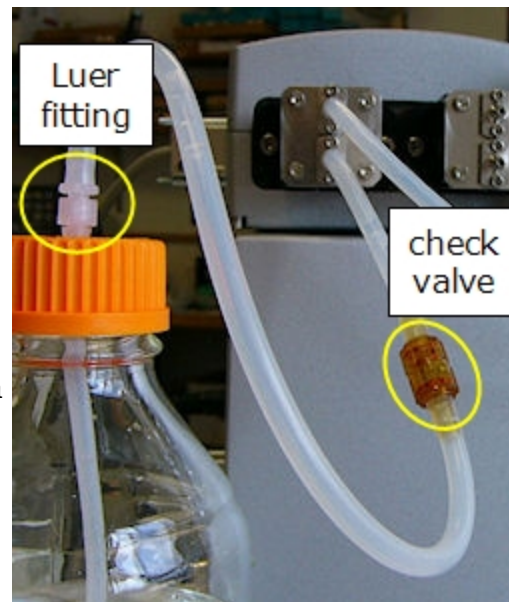

■ Make sure the flow-direction arrows point in the direction that the fluid moves.

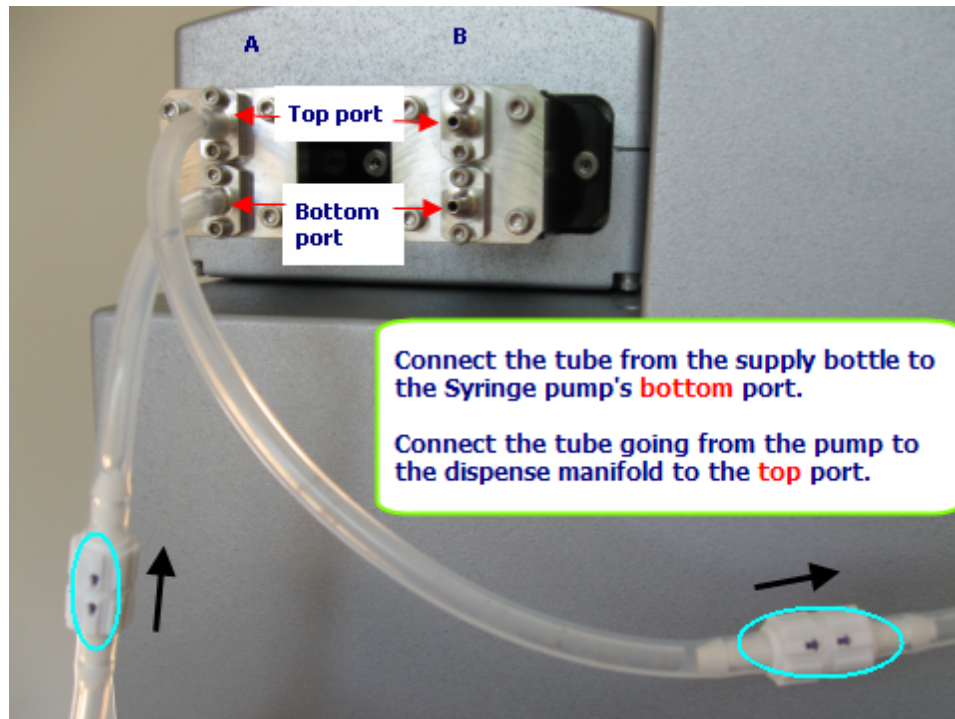

3. With the check valve's flow-direction arrows pointing away from the pump, connect the other tube (without fittings) to the top port of the Syringe pump.
4. Slide the manifold onto the two posts on the dispense arm with the tubing end closest to the instrument. Except for the dual 8-channel manifold that has two manifolds in one block, install Syringe A's manifold first. Syringe B's manifold must be installed after Syringe A's.
5. Connect the supply tube to the dispense manifold.

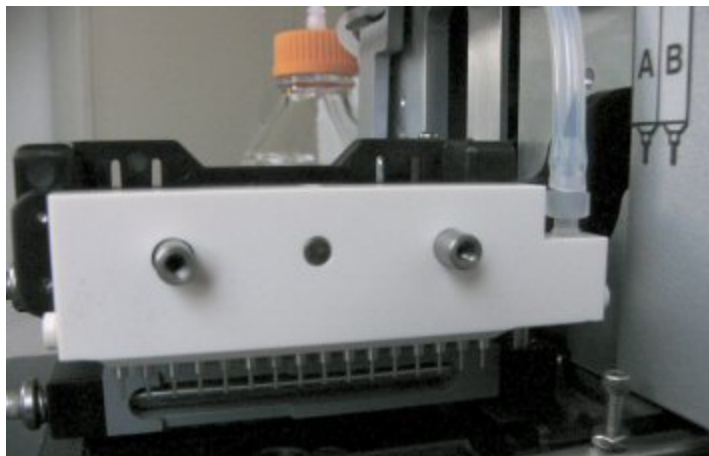

- Images of syringes on the instrument, labeled A and B, indicate the placement of each dispenser's manifold: A slides on first, then B.

- **Special procedure required for magnetic bead assays!** A magnet holds the two manifolds in place on the dispense arm. You can remove the magnet when necessary for certain assays ([as described on page 151](#)).

You can install the tubing bracket:

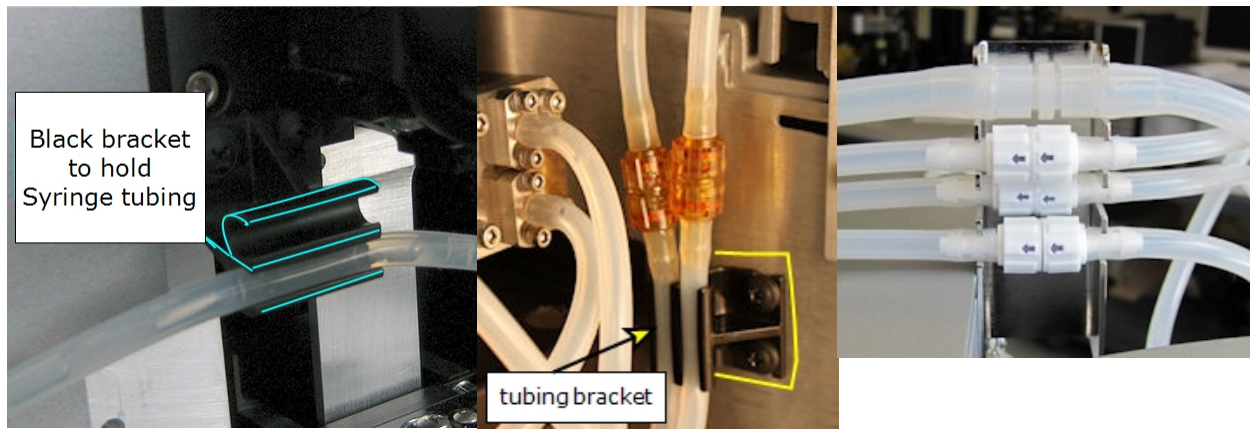

on the front near the Peri-pump

on the back next to shelf

or share washer/RAD bracket

6. Make sure the manifold has enough slack in the tubing to move down to the priming trough and then press the tubing into the tubing bracket to keep the tubing out-of-the-way.

- When the Syringe is installed on the back shelf, you must temporarily move the pump unit to get access to the tubing bracket.

- When the Syringe is installed on top of the washer, use the washer's tubing bracket, instead.

7. Repeat the tubing and manifold installation for Syringe B.
8. (Optional) Insert the thumbscrews into the posts that hold the manifolds. (Magnets keep the manifolds attached to the dispense arm. The thumbscrews are provided in case the magnets interfere with operation, e.g. for magnetic bead assays.)

- Important! You must [Update the instrument to use the Syringe Dispenser on page 74.](#)

Syringe Dispenser Check Valves

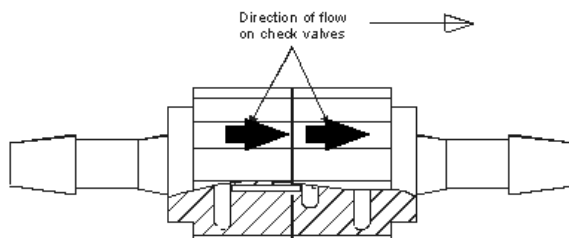

Note the flow direction arrows on the check valves. Some are harder to see than others. The flow direction arrows are engraved valves into the translucent plastic.

- PN 68083 — Autoclavable valves for use with non-organic substances. The direction arrows are difficult to see.
- PN 68073 — Check valves recommended for use with organic substances. They cannot be autoclaved. Direction arrows are easy to see.

■ Note: If the check valves are replaced, it may be necessary to recalibrate the syringe backlash to achieve optimum accuracy performance. [See Calibrate the Backlash for Syringe Dispenser on page 212](#) for instructions.

Make sure the flow-direction arrows on the check valves point toward the pump from the supply vessel, and towards the dispense manifold from the pump.

Install Inline Filter for 32-Tube Dispensers

BioTek ships two 90-micron inline filters with the 32-tube dispense manifolds to reduce the chances of clogging the dispense tubes. It is especially important for the SB – small bore models.

To install the filters:

1. Locate and layout the length of tubing that goes between the supply bottle and the Syringe pump; it has the Luer fitting on one end.
2. Cut the tubing approximately one to two inches (3-5 cm) above the Luer fitting.

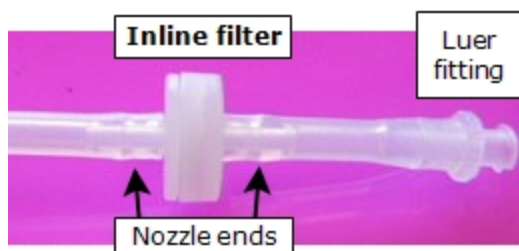

3. Slide the filter's nozzle ends into the two ends of the tubing, reconnecting it.

Install Software/Connect to Computer

If you purchased BioTek's Liquid Handling Control™ (LHC) Software to control the MultiFlo FX using your personal computer (PC), please refer to the LHC Installation Guide for complete installation and setup instructions.

Connect to Host Computer

Two cables are shipped with the MultiFlo FX:

If using the serial cable: Plug one end into the **RS232** serial port on the instrument and the other end into an available port on the computer.

If using the USB cable: Plug one end into the **USB** port on the instrument and the other end into an available port on the computer.

- If the computer is connected to the Internet, turn on the instrument. Let Windows[®] automatically locate and install the necessary USB drivers (follow the online instructions), if applicable or open the link below to download the drivers.
- Virtual Com Port (VCP) drivers for all Windows operating systems are available at <http://www.ftdichip.com/Drivers/VCP.htm>
- If the computer is NOT connected to the Internet, install the drivers using the supplied “Virtual USB Com Port” driver software CD.

■ The Home screen must be displayed for the LHC to communicate with the instrument.



Technical Note: Only one of the two communication ports (COM port) on the instrument can be used at a time. They cannot be used simultaneously. You can use USB to connect the MultiFlo FX to the computer or the RS232 serial port to connect to a BioStack or similar robotic device. But you cannot use both ports simultaneously, i.e. make sure only one cable is plugged in at a time.

Connect Power Cable



Warning! Power Rating. The MultiFlo FX must be connected to a power receptacle that provides voltage and current within the specified rating for the system. Use of an incompatible power receptacle may produce electrical shock and fire hazards.



Warning! Electrical Grounding. Never use a two-prong plug adapter to connect primary power to the MultiFlo FX. Use of a two-prong adapter disconnects the utility ground, creating a severe shock hazard. Always connect the system power cord directly to a three-prong receptacle with a functional ground.

The MultiFlo FX supports voltage in the range of 100-240 V~ at 50-60 Hz.

1. Connect the power cable to the power supply.
2. Plug the power supply cable into the power socket in the side panel of the MultiFlo FX.
3. Insert the three-prong plug into an appropriate receptacle.

Define Instrument Settings

LHC Users Only



When using the LHC to control the MultiFlo FX, an important first step is defining your instrument's settings. After installing the LHC, you can use the desktop icon or the Windows Start button to launch the LHC:



> **All Programs**> **BioTek**> **Liquid Handling Control**

1. Click the **Name** link on the main page and, if required, select the MultiFlo FX.
2. Specify the COM **Port** used to connect the MultiFlo FX to the computer (use the drop-down list to select the port) and click **Test Communication**.
 - o **Pass**: proceed to the next step.
 - o **Fail**: check the Com Port setting. See "About Com Ports" in the LHC Help.
3. In the **Target Instrument Settings** dialog that opens, click **Get actual settings now**, and click **OK**.

Enable Waste Sensor

Wash models only: If you purchased the optional waste sensor accessory, enable the waste sensor:

Using the Touch screen	Using the LHC
<ol style="list-style-type: none"> 1. Select Instrument>Washer. 2. Touch the field to enable Waste detection under Sensors Enabled. 3. Press the Home button. 	<ol style="list-style-type: none"> 1. Select Tools>Instrument Utilities. 2. Under Strip Washer, fill the checkbox to enable Waste Detection. 3. Click Send, and then, Exit.

Update the Instrument to use the Syringe Dispenser

An important part of installing the dual Syringe Dispenser is updating the instrument's basecode (internal software) with its calibration data. A data sheet is affixed to the bottom of the Syringe pump unit and to the front page of the installation instructions.

Touch screen users: Use the USB flash drive and enter both data sets, for the 8- and 16-Tube Manifolds.

USB Flash Drive: plug in the USB flash drive containing Syringe calibration data to update the MultiFlo FX automatically.

8 -Tube Manifold

Calibration Data for SN: 276922

Syringe	A	B
Cal Pt 1	90.8	95.8
Cal Pt 2	159.2	165.8
Cal Pt 3	317.5	323.3
Cal Pt 4	636	643
Cal Pt 5	1273	1282
Cal Pt 6	8943	8948
Backlash		
8 & 16 - Tube	16	21
32-Tube LB	11	18
32-Tube SB	17	22
Checksum: 7D2F		

16 -Tube Manifold

Calibration Data for SN: 276922

Syringe	A	B
Cal Pt 1	52.9	53.3
Cal Pt 2	148.3	147.5
Cal Pt 3	318.3	320.0
Cal Pt 4	625	635
Cal Pt 5	1262	1270
Cal Pt 6	8930	8938
Backlash		
8 & 16 - Tube	4	9
32-Tube LB	8	14
32-Tube SB	13	19
Checksum: FA61		

LHC	Touch screen
<ol style="list-style-type: none"> 1. Connect the syringe pump unit to the instrument with its serial cable. 2. Turn on the instrument, launch the LHC and make sure it is communicating with the MultiFlo FX (define the correct COM port). 3. Select Tools>Instrument Utilities>Syringe Dispenser. 4. Under Syringe Dispenser Assembly, specify the type of pump and the installed manifold type and click Send to download the data to the instrument. 5. In the Calibration Data section, enter the data points on the label in the corresponding fields, including the Serial Number or plug the USB flash 	<ol style="list-style-type: none"> 1. Connect the syringe pump unit to the instrument with its serial cable. 2. Turn on the instrument, and press Instrument. 3. Select Syringe and specify the installed manifold type. 4. Under Calibration Data from, press the link for each manifold, one at a time, and either Import from USB or enter the Serial Number (SN) and all the data points by pressing each field to open the number pad. <ul style="list-style-type: none"> ■ Enter both data sets. 5. Press Save this Data when done and confirm that the Checksum displayed onboard matches the Checksum on the

LHC	Touch screen
<p>drive into your computer and select Import from a file. Lastly, click Send.</p> <p>6. Wait for the confirmation message and verify the Checksum displayed matches the Checksum on the label. This ensures the data was input correctly.</p> <ul style="list-style-type: none"> Click Retrieve at any time to check the Checksum. 	<p>label. This ensures the data was input correctly.</p>

■ **Important:** If the Checksum does not match there was a data input error and dispense accuracy will be compromised. Redo the procedure, carefully comparing the data points on the label to the values entered. When importing data from the USB flash drive, confirm the serial number on the USB matches the one on the Syringe unit.

Change the Syringe Dispenser Manifold

Changing the Syringe manifold requires two steps:

- Physically changing the Syringe dispenser manifold: [See **Install the Syringe Dispenser Component on page 62**](#).
- Updating the instrument's manifold setting; as described below.

After physically changing the manifold, perform these steps to tell the instrument which manifold is installed.

- LHC: Select **Tools> Instrument Utilities> Syringe Dispenser**
Touch screen: Select **Instrument> Syringe> Manifold**

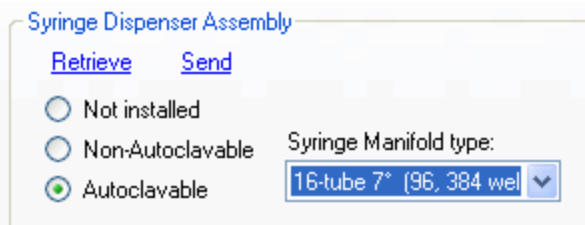

- Choose the option that represents the installed manifold. Look at the top of the manifold to identify its type, which is engraved on the top:

8-tube	Dual 8-tube manifolds in a single block.
16-tube	16-channel.
32-tube	1536-well plates only; Model: Large Bore (LB) or Small Bore (SB).
8-tube	6-well plates only; 4 tubes per well.
9-tube	12-well plates only; 3 tubes per well.
8-tube	24-well plates only; 2 tubes per well.
12-tube	48-well plates only; 2 tubes per well.

- LHC: Click **Send** to send this setting to the instrument.

Change the cassette type setting

The Peri-pump **Cassette Type setting** must be correct.

Note: Internal and External Peri-pump Dispensers: When the MultiFlo FX has an internal or built-in peristaltic pump it is called the Primary Peri-pump and an external pump is called the Secondary Peri-pump. When an instrument has only one pump, either internal or external, it is called Primary.

LHC	Touch screen
<ol style="list-style-type: none"> Select Tools>Instrument Utilities Select the Peri-pump tab. Select the correct button for the Cassette Type installed for the primary or secondary Peri-pump, if applicable. Click Send to update the instrument. 	<ol style="list-style-type: none"> From the home screen, select Instrument>Peri-pump. Select the Cassette Type for each dispenser: Primary and Secondary, as applicable.

 **Tip:** You may want to employ the [Cassette Requirement Mode](#) feature (*as described on page 158*) to automatically update the instrument's Cassette Type setting when you run a protocol. For advanced users with well organized procedures, the MultiFlo FX provides the ability to change the cassette type setting on-the-fly. It uses the "Require a specific cassette" parameter in a Peri-pump step to automatically change the cassette type setting if it does not match the required cassette.

Setting the Time and Date

Set the time and date to permit the MultiFlo FX to record "last run" and "last modified" data for each protocol. Only the U.S. date format is available (MM/DD/YYYY). An internal battery keeps the time and date valid when the instrument is turned off. Always set both the time zone and the actual time, i.e. selecting the time zone does not synchronise the time setting.

1. Select **Instrument** from the Home screen, press Next and then, **Other**.
2. Select **Set Time and Date**.
3. Update the time zone, date, and time:
 - **Time Zone:** Touch the **Select Time Zone** button and select the option that matches your location. GMT = Greenwich Mean Time.
 - **Time:** Touch the time field to open a number pad. Enter the current hour and minutes to set the 24 hour clock. Touch the number field to put it in edit mode.
 - **Date:** Touch today's date on the calendar to select it. Press the previous or next arrows (up or down) to scroll to the correct month.
4. Press **Save**.
5. Restart the instrument.

 Remember to update the time in accordance with annual time shifts, like Daylight Savings Time, if applicable.



Note: The sort order of the protocol list on the Home screen determines which date is displayed. When "Last run" is selected, this date is shown, when the list is sorted "Alphabetically" the last modified date is displayed. Select **Instrument>Preferences** to change the sort order.

Define Startup Preferences (LHC users only)

You can save enormous time creating protocols by following these steps to define a **New Protocol** template and use it at startup.

Create a protocol template

1.  Click the **New** button or select **File>New**.
2. Click **Name**. Select the MultiFlo FX and define its **Port** and **Settings**.

3. *Highly Recommended*: select the **Plate Type**, fill in the text fields, and add any steps that you want all new protocols to include.
4.  Click **Save** and assign a unique name, e.g. Template.LHC.
5. Select **Tools>Preferences>New Protocol**.
6.  Select the button for **Protocol selected below to use as a template**.
7. Click **selected** and select the protocol you created as a template.

Define startup behavior:

8. After completing the steps above, select the **Startup Options** tab.
9. Select the button for **New Protocol**.
10. Click **OK** to save your new preferences.

Verify Performance

Before using the MultiFlo FX for the first time, verify that it is operating properly.

- When using the LHC, make sure the MultiFlo FX is connected to the PC and both are powered up.
- When running standalone, turn on the MultiFlo FX.

Using the touch screen:

Press **Instrument>About >Self-Check**.

Using the LHC:

1. Click the **Name** link on the main page and, if required, select the MultiFlo FX.
2. Define the COM **Port** used to connect the MultiFlo FX to the computer and **Test Communication**.
3. In the Target Instrument Settings dialog that opens, click **Get actual settings now**, and click **OK**.
4. Select **Tools>Instrument Utilities**
5. On the General Settings tab, click the Perform **Self-Check** link.

Test results:

- **Pass**: no error message is displayed.
- **Fail**: an error message is displayed. If this happens, note the error code and refer to [Troubleshooting on page 272](#) to determine its cause. If the problem is something you can fix, turn off the instrument, fix the problem, and then turn the instrument back on. Otherwise, contact BioTek's Technical Assistance Center.

■ **Note:** An **instrument qualification package** (PN 1260521) for the MultiFlo FX is available for purchase from BioTek. The package contains thorough procedures for performing Installation Qualification, Operational Qualification and Performance Qualification (IQ/OQ/PQ) and preventive maintenance (PM). Extensive Checklists and Logbooks are included for recording results.

■ **Important!** Before operating the instrument, review [Optimize Performance on page 98](#). The guidelines include necessary steps to perform before running a protocol, and issues to consider when creating or editing protocols.

Verify the Peri-Pump Dispenser

1. Fill the Peri-pump's supply bottle with approximately one liter of deionized water.

LHC	Touch screen
<ol style="list-style-type: none"> 1. Select File > Open. 2. Open the MultiFlo FX and Maintenance Protocols folders, and then open P-xUL_CASS_RINSE.LHC* <i>You may need to reset the Com Port.</i> 3. When ready, click the Run button to prime the tubing and manifold with deionized water. 4. When finished, close the program. 	<ol style="list-style-type: none"> 1. Select Quick at the Home screen. 2. Select Device Prime and set the Device to the Peri-pump Primary. 3. Press the PRIME button. <p>Repeat for Peri-pump Secondary, if applicable.</p> <ol style="list-style-type: none"> 4. When done, press the Home button.

*Verify both a standard cassette and a RAD technology cassette, if applicable.

If leaks were detected, tighten all tube fittings and re-run the program. If leaks are still detected, contact BioTek's Technical Assistance Center.

Verify the Syringe Dispensers

1. Fill the supply bottles with approximately one liter of deionized water, one for each syringe pump.

LHC	Touch screen
<ol style="list-style-type: none"> 1. Select File > Open. 2. Open the MultiFlo FX and Maintenance Protocols folders, and then open S-DAY_RINSE_A&B.LHC <i>You may need to reset the Com Port.</i> 3. When ready, click the Run button to prime the tubing and manifold with deionized water. 4. When finished, close the program. 	<ol style="list-style-type: none"> 1. Select Quick at the Home screen. 2. Select Device Prime and set the Device to the Syringe Both. 3. Press the Start button. 4. When done, press the Home button.

If leaks were detected, tighten all tube fittings and re-run the program. If leaks are still detected, contact BioTek's Technical Assistance Center.

Verify the Washer Component

1. Fill the washer's supply bottle with approximately one liter of deionized water.

LHC	Touch screen
<ol style="list-style-type: none"> 1. Select File > Open. 2. Open the MultiFlo FX and Maintenance Protocols folders and then open W-DAY_RINSE.LHC You <i>may</i> need to reset the Com Port. 3. When ready, click the Run button to prime the tubing and manifold with deionized water. 4. When finished, close the program. 	<ol style="list-style-type: none"> 1. Select Maintenance at the Home screen. 2. Select W-Day_Rinse and press Start. 3. When the protocol is completed, press the Home button.

If leaks were detected, tighten all tube fittings and re-run the program. If leaks are still detected, contact BioTek's Technical Assistance Center.

Repacking the MultiFlo FX

Prior to sending your instrument to us for repair, log into the Customer Resource Center (www.biotek.com) to submit a Service Request for a Return Material Authorization (RMA). Your serial number is needed to process an RMA.

- Failure to comply with the following instructions will void the instrument's warranty.
- Decontaminate the instrument before returning it: [See Decontamination on page 205.](#)

If the original packing materials have been damaged or lost, contact BioTek to order replacements. Part Numbers: 7213006 for the main instrument, 1263003 for the washer, and 7213008 for the secondary Peri-pump and 1263004 for other accessories, if applicable.

Prepare the instrument for shipping bracket installation:

1. Remove the Peri-pump dispense cassette and the Syringe dispenser and washer manifolds, if applicable.
2. Uninstall and repack separately the Syringe pump and its accessories, and the strip washer and its accessories, if applicable.
3. Slide the plate carrier into position next to the dispense arm. It will be secured in place by one of the shipping brackets.

View the illustrations provided:

- [Repacking Secondary Peri-pump](#): it ships with the instrument (if applicable).
- [Repacking the instrument](#): put the instrument (and accessories) into shipping boxes.
- [Repacking the Syringe Dispenser](#) (if applicable).
- [Repacking the Strip Washer](#) (if applicable) .

Obtain an RMA number:

- Contact BioTek TAC to obtain a Return Materials Authorization number,
- Write "RMA" on the shipping box in large, clear letters,
- And, include the RMA number in the shipping address label:
BioTek Instruments, Inc.
ATTN: RMA# xxxxx
15 Tigan Street
Winooski, Vermont 05404 USA

Install the Shipping Hardware

Install the two shipping brackets to protect the MultiFlo FX during shipping.

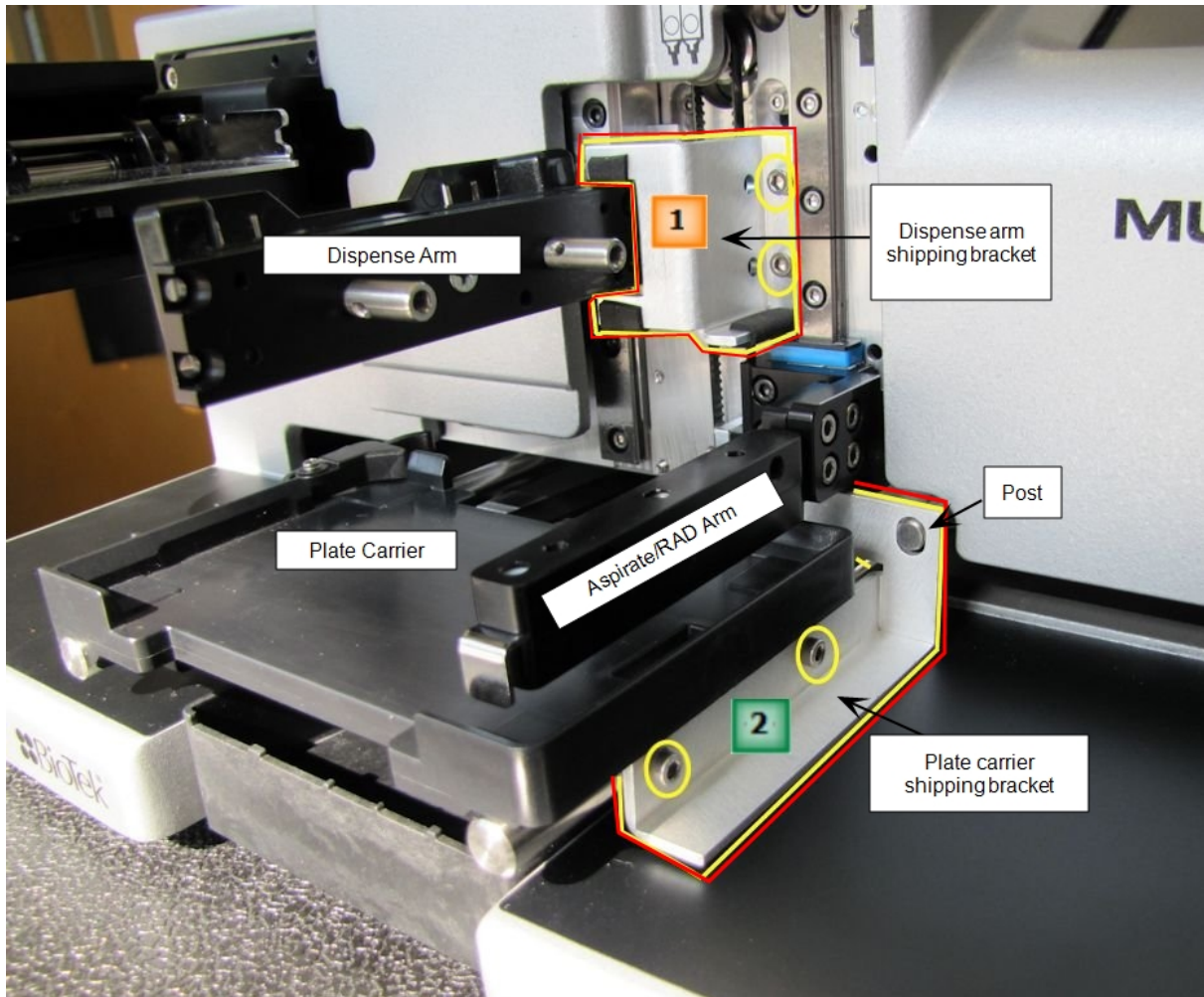

You will need:

- Allen (or hex) wrench provided with the instrument.
- The shipping brackets removed from their storage slots on the back of the instrument.

 Reverse the process of "[Removing the Shipping Hardware](#)."

The shipping hardware is slightly different than shown above for MultiFlo FX without a washer or RAD technology:

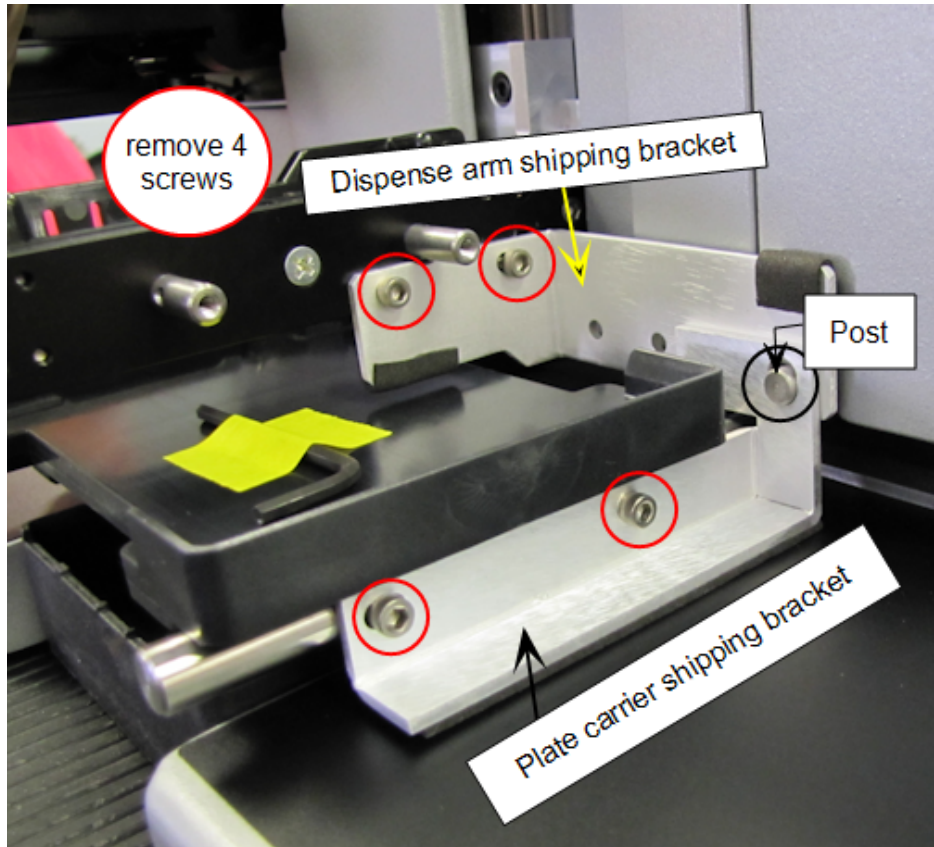

For these MultiFlo FX models:

- MFX
- MFXP

First remove the plate carrier shipping bracket and then remove the dispense arm bracket.

Reverse this order when reinstalling the brackets (before shipping): put the dispense arm bracket on the post first.

Install shipping brackets:

1. First, remove the dispense cassette, Syringe dispenser manifolds or spacer block and washer manifolds, as needed.
2. Lower the aspiration arm as far as it will go and raise the dispense arm. (Does not apply to MFX and MFXP models.)
3. Secure the dispense arm with its shipping bracket, aligning it with its screw holes, and use the Allen wrench to install the two screws that hold it to the instrument.
4. Slide the plate carrier to the left, positioning it below the dispense arm.
5. Insert the plate carrier shipping bracket: rest the bracket on its post and align it with the screw holes; use the Allen wrench to insert the two screws to hold it to the plate carrier.

With the shipping hardware installed, you are ready to pack the instrument in its shipping container.

Repacking the Secondary Peri-pump

- The instrument's packaging design is subject to change over time. If the instructions in this section do not appear to apply to the packaging materials you are using, please contact BioTek's Technical Assistance Center for guidance.

Multiple accessory modules are available for the MultiFlo FX. Foam blocks are used as space fillers in the packing containers when the modules, like the secondary Peri-pump, are not shipped.

Uninstall the Secondary Peri-pump

1. Reverse the installation procedure: [Install the Secondary Peri-Pump on page 46](#) to remove the Secondary Peri-pump from the top of the MultiFlo FX.
2. Wrap a rubber band around the pump itself.
3. Place the module in the plastic bag and put it in its shipping box.

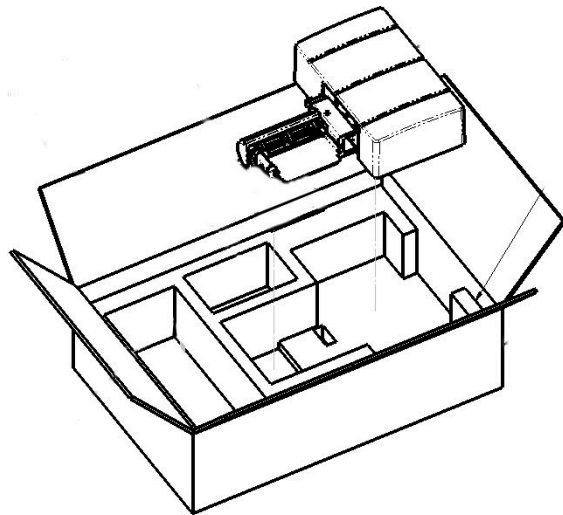

RAD™ Technology Components

1. Put the RAD components into their respective plastic bags and then into the small shipping box included with the Secondary Peri-pump.
2. Tubing bracket: insert the thumb screw into the bracket.
3. Put the ribbon and serial cables in the cardboard tray that fits on top of the other RAD components.
4. Tape the accessory box closed.

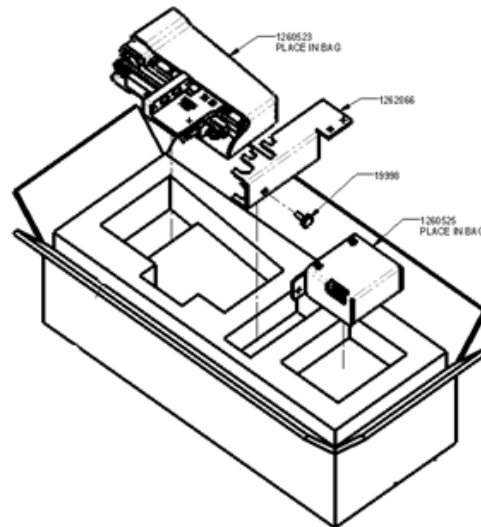

Put it all together

1. Pack other accessories and the power cord in the box.
2. Repack the cardboard and foam shipping materials to secure the items in place.
3. Tape the box closed. This box will fit into the box with the instrument.

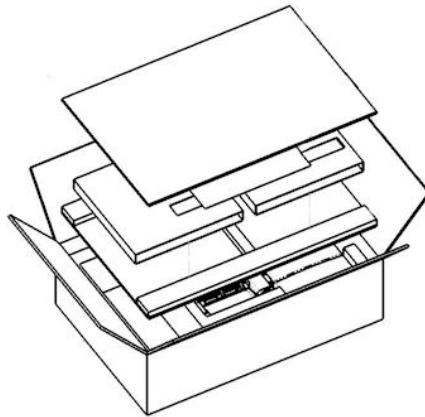

MultiFlo FX Repacking

1. Reverse the steps described to Remove the Shipping Hardware. First remove the two shipping brackets from the back of the instrument, then install them.
2. Put a rubber band around the Peri-pump.

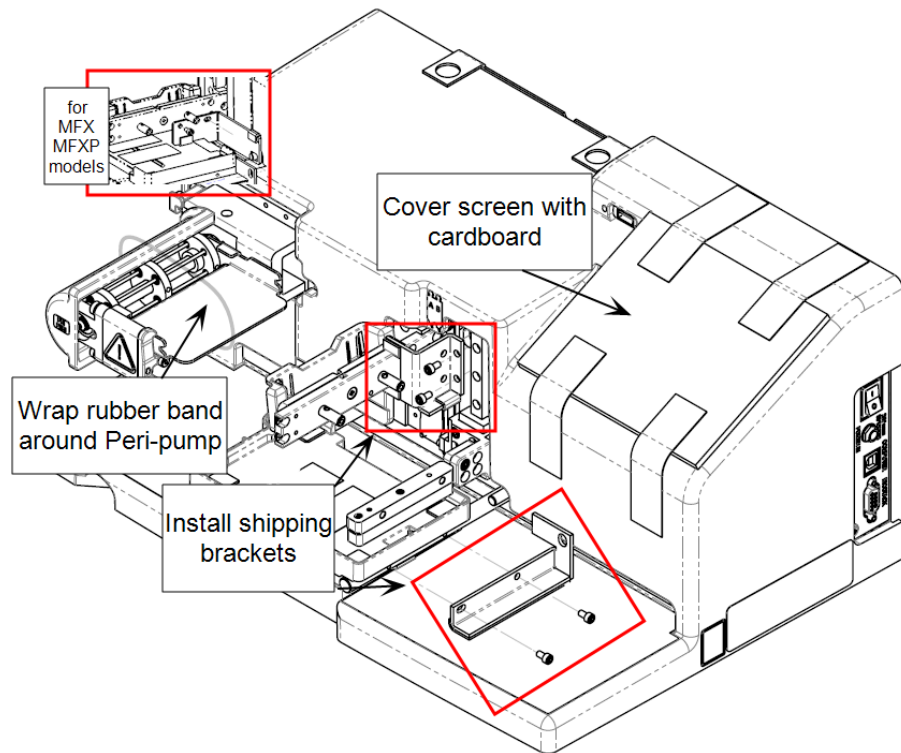

3. With the shipping hardware installed, sit the instrument in the foam edged box bottom.
4. Place the end caps on either side and put all items inside the interior shipping box.
5. Place accessory boxes inside interior box.
6. Tape the box closed.

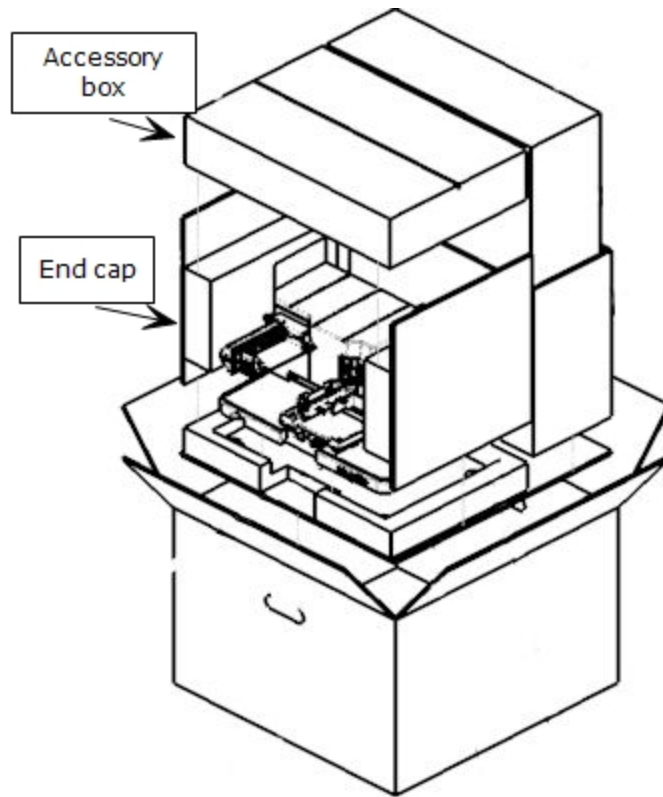

7. Put the eight foam corner blocks on the interior box and put it inside the outer box.
8. Tape the outer box closed.
9. Write "**RMA**" in large, clear letters on the outer box.
10. Include the RMA number in the address label.

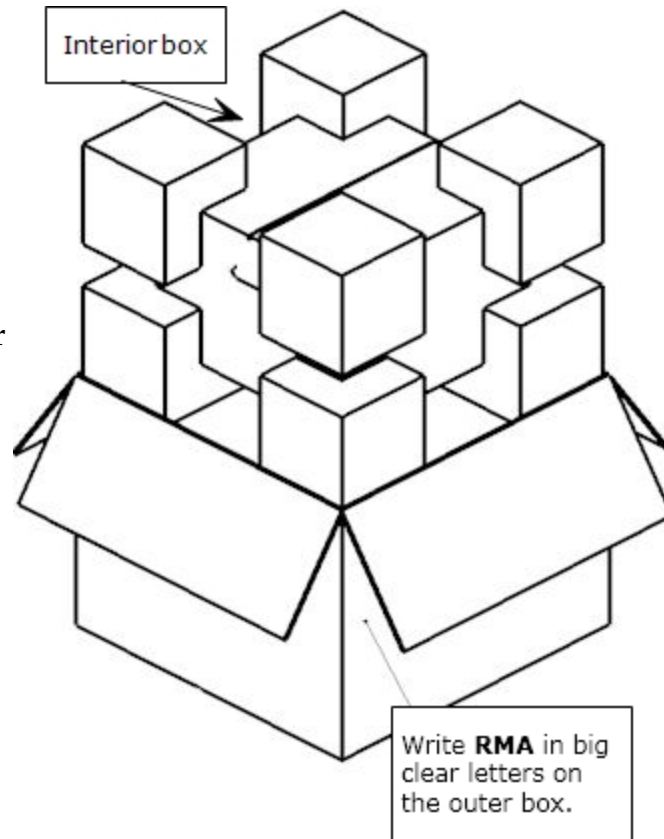

Repacking the Syringe Dispenser

After preparing the instrument for shipping, and reversing the installation steps, pack the Syringe dispenser as shown here:

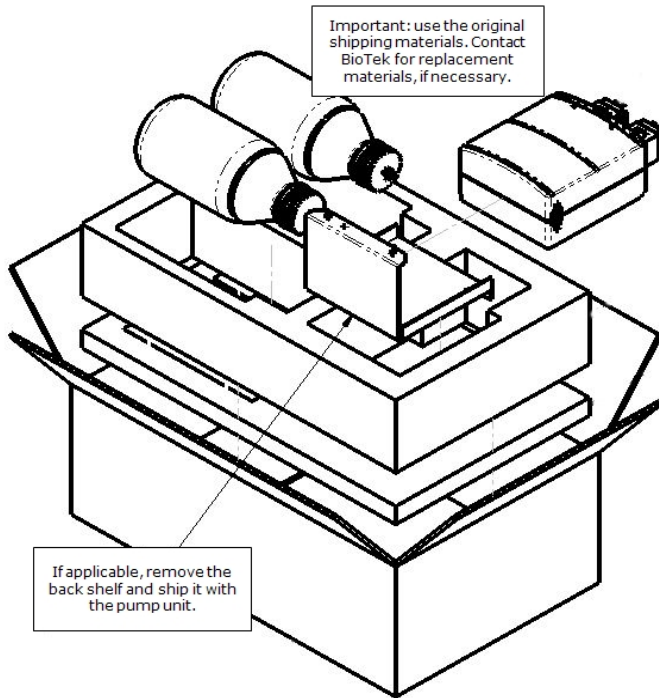

Fill the foam tray with the Syringe dispenser accessories and place the tray on top of the inner foam box containing the pump and supply bottles.

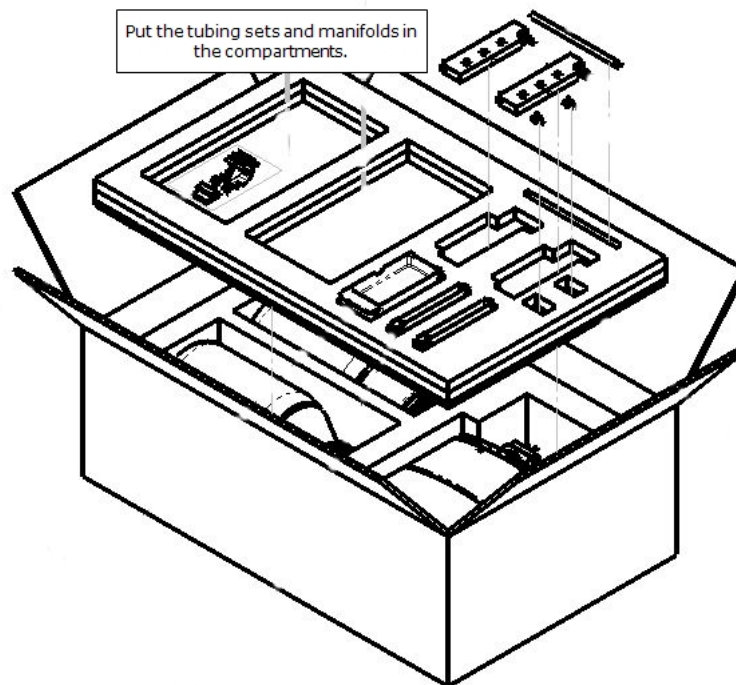

Repacking the Strip Washer

- The instrument's packaging design is subject to change over time. If the instructions in this section do not appear to apply to the packaging materials you are using, please contact BioTek's Technical Assistance Center for guidance.

Uninstall the strip washer:

1. Reverse the installation procedure: [\(as described on page 35\)](#) to detach the strip washer from the MultiFlo FX.
2. Separate the manifolds from their tubing and allow all fluid vessels to completely dry.
3. Pack the washer module and its accessories in the shipping container.
4. Repack the cardboard and foam shipping materials to secure the items in place.
5. Tape the box closed.

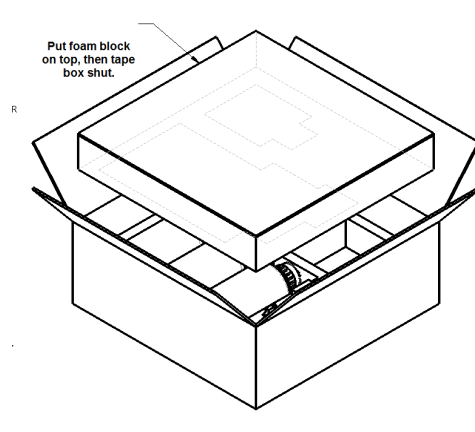
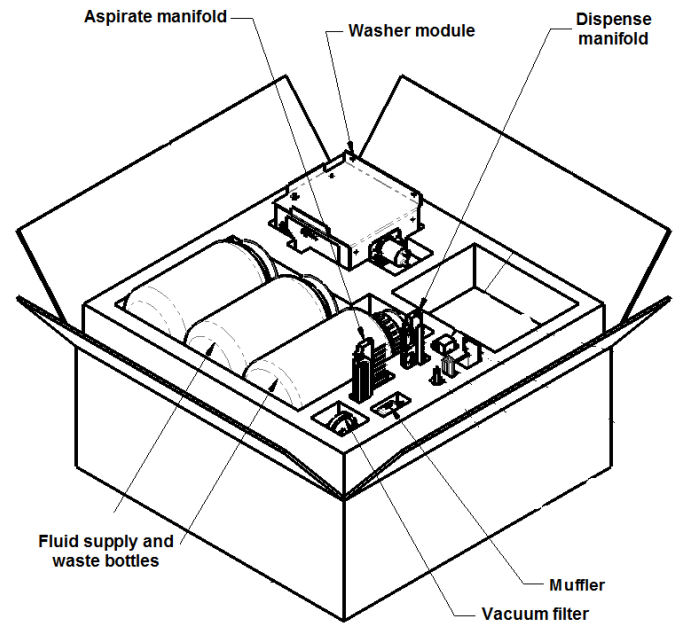

Operation

This chapter provides instructions for controlling the MultiFlo FX.

Touch Screen Basics	92
Optimize Performance	98
Create or Modify a Protocol	102
Protocol Parameters Tables	103
Wash Parameters Table	108
Predefined Protocols Listing	121
Predefined Sample Protocols	122
Operating with the BioStack	124
Advanced Plate Sequencing with the BioStack	129
Plate Types and Processing Patterns	133
Handling Special Plates and Mini-tubes	134
Dispense Processing Patterns	138
Washer Operation	141
Cell Wash	142
Biomagnetic Separation - Magnetic Bead Assays	145
Peri-pump Peristaltic Dispenser	152
Peri-pump: How it works	153
Peri-pump Dispense Step	155
Require a Specific Peri-pump Cassette	158
Peri-pump Advanced Settings	159
Dual Syringe Dispenser	160
Syringe Prime Step	161
Syringe Dispense Step	163
Syringe Dispenser Settings	166
Syringe Dispenser- Autoclavable vs. Non-autoclavable	167
Changing the Instrument's Settings	168

Touch Screen Basics

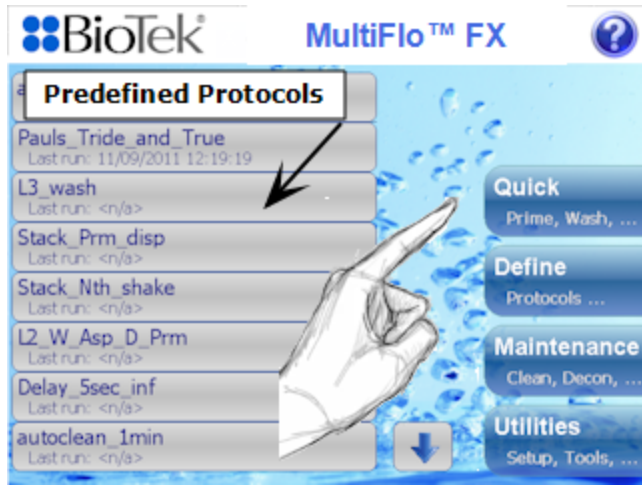

Home screen

- **Fast, Light Touch:** a light, quick tap on the screen produces the best results. Use your fingertip or a pointing device like a pen tip. The touch screen does **not** support gestures, like swiping and zooming, that are common to smart phones.

Do



Do use your fingertip
(precise selection)









Don't

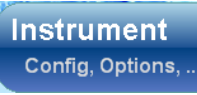

Don't use your finger pad
(uncertain selection)

- **Wash/Dispense Protocols:** Touch a protocol on the **Home** screen to run it. All saved/predefined protocols appear on the Home screen.

	<p>Numbers: Touch any field that requires a numeric value to open a field-sensitive number pad. Use the number pad to specify volume, times, and other values. To enter negative numbers use the down (decrement) arrow.</p>
	<p>Pick Lists: touch a field with a down arrow to open a pick list to select an option.</p>
<p>Name:</p>	<p>Text: Touch any text field or comments box to open a keyboard. Use the keyboard to name protocols, input runtime prompts, enter comments, etc.</p>

	Scrolling: Press the down or up arrows to scroll a list with more items than fit on the screen.
	Quick access to prime the washer/dispenser, wash a plate, dispense to or aspirate from a plate, depending on the devices installed.
	To create and modify protocols.
	To run maintenance and quality control protocols.
	To change instrument settings, obtain protocols from a memory stick, etc.
	Home: Press the home button to return to the Home screen at any time.
	Previous: Press the previous button to go to the previous screen.
	Help: To learn more about a screen, press its Help button.
	Green buttons make the MultiFlo FX perform.

Quick Prime

At the Home screen select Quick>Device Prime

Priming removes air bubbles from the tubing, ensuring optimal performance. Fluid is dispensed to the priming trough. You can use Quick Prime to comply with the daily maintenance recommendations.

Quick Prime works best immediately prior to running a protocol to correct for evaporation, i.e. to normalize the dispense tips and remove any air from the tubing. Run a Maintenance protocol (multiple times, if necessary) when changing fluids to more quickly and thoroughly flush the system.

- [Recommended prime volumes for the Peri-pump on page 99](#)
- [Recommended prime volumes for the Syringe dispensers on page 101](#)
- [Recommended prime volumes for the Strip Washer on page 99](#)

- Note: the washer aspirates fluid during the prime step, but it does not fully evacuate the priming trough insert.

Quick Dispense

Quick Dispense uses default values for all parameters except those available for modification. To alter the flow rate, dispense height, and other parameters, you must define a protocol. The [Magnet Adapter Height](#) and [Plate Clearance](#) instrument settings apply to the Quick Dispense runs.

Important: Always prime the dispenser before dispensing! This Quick Dispense begins with two pre-dispenses to prime the tips, to correct for evaporation. But, pre-dispense is insufficient for removing air bubbles from the tubing.

- Quick Dispense is not recommended when using the 8-to-1 bulk-dispensing cassette. [See RAD Tip Tracking on page 156](#)

1. Press **Device** (if necessary) to select the dispenser you want to use.
 - When using the Peri-pump, make sure its [Cassette Type](#) setting matches the currently installed cassette: [See Change the cassette type setting on page 76](#). Refer to instructions for physically changing the cassette: [Install the Dispense Cassette on page 56](#).
 - 0.5 μL dispensing is **not** an option via the [Quick](#) menu. You must define a protocol to dispense half-microliter (500 nL).
 - Press **Volume** to define the per well dispense volume in microliters (μL). Depending on the device and the plate type, multiple dispense tubes per well may be used. The washer and Syringe dispenser calculate the correct volume per tube to meet the specified per well dispense volume. (The Peri-pump does not! See below.)
2. When the desired values are entered, put a plate on the carrier and press **Start** to run the routine.

- **1536F:** For best performance with this plate type use [Syringe-BOTH](#) (both Syringe A and B) and remove the Peri-pump dispense cassette, or remove the Syringe manifolds when dispensing with the Peri-pump.

- ***Important:** when dispensing to 6-, 12-, 24- and 48-well plates (with a non-RAD cassette) some dispense tubes must be removed from the Peri-pump's

fluid supply vessel. [See Handling Special Plates and Mini-tubes on page 134.](#)

Quick Wash

Home>Quick>Basic Wash

Quick Wash uses default values for all parameters except those available for modification: volume, plate type, number of cycles. Quick Wash is useful when you do not need to retain protocol parameters for future use or reference. The [Magnet Adapter Height](#) and [Plate Clearance](#) instrument settings apply to the Quick Wash to accommodate non-standard plates.

Define a Quick Wash

1. Touch the field you want to change for a pick list of options or a number pad.
2. Make your selections, put a plate on the carrier, and press **Start** to wash the plate.

Learn more:

- [Create a protocol](#) to save a record of the wash parameters, to confidently repeat the wash procedure and/or to modify wash parameters to improve performance.
- See [Wash Parameters Table on page 108](#) to review options available in a wash protocol.
- See [About the Wash Step](#).

Add protocols to the Home screen

The MultiFlo FX puts all saved protocols on the Home screen for easy retrieval. Create and save a protocol to add it to the Home screen listing.

[Create or Modify a Protocol on page 102.](#)

Remove protocols from the Home screen

All saved protocols appear on the Home screen. To remove a protocol from the Home screen listing:

1. Select **Protocols** at the Home screen.
2. Highlight the protocol you want to remove and press **Delete**.

The protocol file will be permanently deleted.

- To delete a locked protocol, first unlock it.



Locked files: you can "unlock" a protocol by replacing it using the [Protocol Transfer](#) control. Upload the protocol to a USB stick, make sure "[Lock files](#)" is disabled and re-transfer the protocol. It will overwrite the existing file.

Get protocols from a memory stick - USB drive

Important: Put the protocols you want to transfer to the washer in a folder called **Protocols**. The MultiFlo FX expects to find a Protocols folder on the memory stick.

You can exchange MultiFlo FX protocols with other users, copy protocols from one washer to another, or obtain sample protocols from BioTek's website using a USB stick:

1. Insert the memory stick into the USB port on top of the washer.
2. Select **Instrument>Next>Other** from the Home screen.
3. Press **Transfer Protocols**.
4. Choose the **File Source: USB** to copy protocols from it to the washer.
(Conversely, choose **Internal** to copy protocols to the USB flash drive to share them with another instrument.)
5. Optionally, apply the **Lock files** option to prevent users from changing the protocols.
6. Select files individually by highlighting them (touch) or transfer all protocols simultaneously.



Locked files: you can "unlock" a protocol by replacing it using the [Protocol Transfer](#) control. Upload the protocol to a USB stick, make sure "[Lock files](#)" is disabled and re-transfer the protocol. It will overwrite the existing file.

Hardware Change Detected

The MultiFlo FX displays a message at start up when it detects a configuration change, e.g. a dispenser is unplugged.

- **At installation:** Syringe Dispenser users must enter calibration data. See [Update the instrument to use the Syringe Dispenser on page 74](#).

- **Ongoing operation:** Check your instrument setup for any unintended changes: are the serial cables properly connected to the back of the MultiFlo FX?

Optimize Performance

Here are some guidelines to ensure optimal performance and to prevent problems.

Keep the devices clean and the tubing wet

The most critical factor for ensuring optimal performance is to adhere to the [Recommended Maintenance Schedule on page 176](#). Enable **AutoPrime** to keep tubes from clogging.

Prime the tubing to remove air bubbles

- See [Recommended prime volumes for the Peri-pump on the facing page](#)
- See [Recommended prime volumes for the Syringe dispensers on page 101](#)
- See [Recommended prime volumes for the Strip Washer on the facing page](#)

Best Practices for all MultiFlo FX Devices

- Fill the supply bottles with sufficient fluid.
- Make sure the bottles, solutions, and tubing are clean and do not contain any particles or mold. Solutions that are recycled over several days will grow algae, bacteria, molds, or other undesirable organisms.
- Prime before dispensing. Priming the tubing is the most critical factor in assuring optimal performance.
- Check the external tubing connections for kinks and clogs.
- Put microplates on the carrier with well A1 in the left rear corner as you face the instrument, and firmly seat the plate in the carrier.
- To more quickly dispense to 384- and 1536-well plates, use the Instrument Utilities to change the **Dispense Pattern** to Row. If precision is more important than speed, keep the pattern set to Column.

Before using the Peri-pump

- See [Release the tension on the dispense cassette on page 154](#).
- For top performance and to preserve precious fluids, **Purge** the fluid at the end of a dispense run and **Prime** the tubing before dispensing. The tubing is permeable to air. When 20 minutes or more have elapsed between dispenses, or less than 20 minutes when using 1 μ L cassettes, it is important to thoroughly prime the tubing before dispensing.
- Use the **priming trough insert** to capture expensive reagents for reuse. The Peri-pump's insert can hold up to 12 mL.
- Filter the dispense fluid to 50 microns before dispensing with the 1 μ L cassettes. The dispense tips are very small. Filtering the fluid helps prevent clogging.

- **Select the right cassette for the job:** match your desired dispense volume to the recommended cassette. The smallest recommended volume for a cassette type is one aliquot. An aliquot matches the cassette type, 1 μL for the 1 μL cassette, 5 μL for the 5 μL cassette, and 10 μL for 10 μL cassette. Except the RAD technology 8-to-1 cassette with 5 μL tubing, one aliquot is $5 \times 8 = 40 \mu\text{L}$.
- **Dedicate cassettes for specific fluids** or applications. Reserving specific cassettes for specific uses avoids contamination.
- When the dispenser is idle, **release the Tube Tensioner** element of the cassette from its place on the pump to minimize unnecessary stretching of the tubing. This is especially true for the 1 μL tubing. The best practice is to unload the 1 μL cassette when dispensing is completed.



Important: Remove the priming trough inserts when using the 8-to-1 RAD cassette. The chute will collide with both the RAD priming cup and the Syringe dispenser insert if they are left in the priming trough.

Before using the Syringe Dispenser

- Sufficiently prime the Syringe dispenser to ensure precision and accuracy: **increase the number of prime cycles** to adequately remove all air bubbles from the tubing.
- Use the **priming trough insert** to capture expensive reagents for reuse. Each Syringe dispenser's insert can hold up to 6 $\frac{1}{2}$ mL.

Recommended prime volumes for the Strip Washer

The predefined maintenance protocol for the strip washer fully primes the system, pumping 40 mL through the tubing and pump:

- **W-DAY_RINSE** - recommended for daily maintenance and when changing fluids.
- **Quick Prime:** 5,000 μL is dispensed each time the quick prime is run. Recommended for conditioning the dispense tips to correct for evaporation immediately prior to plate washing.
- **[See also Minimum Prime Volumes for the Strip Washer on page 114.](#)**

■ Note: the washer aspirates fluid during the prime step, but it does not fully evacuate the priming trough insert.

Recommended prime volumes for the Peri-pump

Generally, the recommended prime volume is three times the dead volume, where dead volume is the total internal volume of the fluid path. However, a primary advantage of the Peri-pump dispenser is its entirely visible fluid path. This allows you to prime the tubing until all visible signs of air bubbles are dissipated.

Cassette Type	Dead Volume
1 μL	1.20 mL
5 μL	4.23 mL
10 μL	7.36 mL

RAD technology single-tube cassettes have the lowest dead volume:

Type	Dead Vol.
1 μL	150 μL
5 μL	530 μL
10 μL	920 μL

 Use BioTek's [Peri-pump Reservoir Holder on page 60](#) and [Shorten the Dispense Cassette Tubing on page 61](#) to significantly reduce the dead volume to preserve expensive reagents.

At the start of the day:

Prime the tubing to prepare for a dispense run.

1. Reload the cassette and fill the supply vessel:
 - When dispensing solutions not effected by water, prime with the dispense fluid.
 - When dispensing protein solutions, first prime the tubing with a buffered saline solution to remove any traces of water in the tubing, then, prime with the dispense fluid.
2. Press the **Prime** button until fluid flows into the priming trough and all visible air bubbles have been removed.

At the end of the day:

Purge the tubing to reclaim the dispense fluid, then Prime the tubing to flush it clean.

1. Press the **Purge** button until the tubing appears empty.
2. Replace the supply vessel with the appropriate rinse fluid:
 - When dispensing water soluble solutions, use deionized or distilled water.
 - When dispensing protein solutions, first prime the tubing with a buffered saline solution to remove protein particles, then, prime with deionized or distilled water.
3. Press the **Prime** button:

- 1 μL cassette = 5 seconds
- 5 μL cassette = 7 seconds
- 10 μL cassette = 10 seconds.

The MultiFlo FX will prime for this duration each time, which dispenses fluid approximately equal to the dead volume for the cassette type.

Recommended prime volumes for the Syringe dispensers

The predefined maintenance protocols for the syringe dispensers fully prime the system, pumping 40 mL through the tubing and pump:

- **S-DAY_RINSE_A&B** - to fully prime both Syringe systems with 40 mL each
- **S-DAY_RINSE_A or _B** - defined for each Syringe

Modify these protocols as needed when changing fluids and performing other tasks. Edit the protocol to add another prime cycle when changing fluids to make sure all previously used fluid is expelled and replaced with the new liquid.

Quick Prime: 5000 μL is dispensed each time the quick prime is run.



The approximate dead volume for each Syringe dispenser system is 12 mL. Generally, three times the dead volume completely primes the system. When using precious fluids, e.g., expensive reagents, you can change the prime parameters: reduce the volume or number of cycles specified in the predefined protocols or create your own protocols. Use the priming trough inserts to capture expensive reagents when priming.

Optimize protocols to improve evacuation

When a wash protocol leaves too much residual fluid in the wells, optimize the protocol with these recommendations:

- [Add a secondary aspiration to a wash cycle below](#), including **Final Aspirate**,
- Decrease the aspirate **Travel Rate**,
- Add a **Delay** to the Aspirate and/or Final Aspirate step ,
- Lower the aspirate height (Z-axis position).

Add a secondary aspiration to a wash cycle

When too much residual is left in the wells during a wash cycle, you can add a secondary aspiration to reduce it. Secondary aspiration can be performed

immediately after each aspiration in a wash cycle and/or after the final aspiration step.

- Secondary aspiration is also called Crosswise aspiration because it is typically performed in a different location within the well. Reposition the tubes by defining different X-, Y-, and/or Z-axis positions when enabling the secondary aspiration for the most effective evacuation of the wells.

Edit the Wash step or stand-alone Aspirate step to add a secondary aspiration:

LHC	Touch screen
<ol style="list-style-type: none"> 1. Double click the step in the protocol to open it for editing. 2. Click Advanced Options (for Aspirate) and enable Perform Secondary Aspirate. 3. Apply a second aspiration to the Final Aspirate, also, for best evacuation results. 4. Optionally, adjust the position of the manifold as it addresses the wells. 	<ol style="list-style-type: none"> 1. Edit the Wash step or stand-alone Aspirate step: Protocols>Edit. 2. Select Advanced Options (for Aspirate) and enable Perform Secondary Aspirate. 3. Use the Align tool to define a crosswise aspirate position. 4. Apply a second aspiration to the Final Aspirate, also, for best evacuation results.

For example, you may want to adjust the X- or Y- axes to get to hard-to-reach areas of certain types of wells. Or, you may want to lower the height (reduce the Z-axis), to better evacuate fluid.

Create or Modify a Protocol

Home > Protocols

To create or edit a protocol:



1. Select **Protocols** at the **Home/Maintenance** screen.
2. Press **Create** or highlight the protocol and press **Edit**.
3. **Name:**
 - **New protocols:** Touch the name field to open a keyboard. Enter a unique name for the protocol.
 - **Editing protocols:** Press the **Info** button and touch the name field to change the protocol name. This will create a new copy of the protocol you are editing. Later you can delete the original



file, if desired.

4. Plate Type:



- **New protocols:** If needed, touch the plate type field to select a different plate type.
- **Editing protocols:** Press the **Info** button and touch the **Plate Type** field to change the plate type.

5. Add/Edit steps:

- **New protocols:** **Add** a step to the protocol (touch the Add button), select a step and define its parameters.
- **Editing protocols:** Highlight a step and press **Edit** to modify its parameters.
- **Adding steps:** Highlight the **<end of steps>** or a step to be preceded by the new step, and press **Add** and the action button to insert a step.



Copy a similar protocol and then edit it to meet different requirements or to test different parameters.

When editing a protocol, cut and paste steps to move them to the correct position.

6. Continue adding or editing steps, as needed.

7. Press **Save** to save the protocol. All saved protocols are put on the Home screen for easy retrieval.



Optionally, do a test run to verify the protocol performs as expected. Test Run executes the protocol. Fill vessels with water or disconnect them if you want to preserve reagent.



Especially when creating complex BioStack protocols, use the Validate button to check the order of the protocol steps.

Protocol Parameters Tables

For Wash step parameters see [Wash Parameters Table on page 108](#).

Peri-pump Parameters

Step	Option	Description/Values range	Default values																														
Prime		To remove air from the tubing.																															
	Volume:	1-3000 μL	300																														
	Duration:	1-300 seconds	3																														
Dispense																																	
	Volume	The per-well volume to dispense:	10																														
	Up to 30,000 μL per well is supported.	1 μL cassette = 1 - 50 μL and 0.5 μL (HLF-D) for some models*																															
		5 μL cassette = 5 - 2500 μL																															
		10 μL cassette = 10 - 3000 μL																															
	Flow rate:	<p>The rate, $\mu\text{L}/\text{second}/\text{tube}$, that fluid is dispensed for each cassette type:</p> <table border="1"> <thead> <tr> <th>Cassette Type</th> <th>1 μL</th> <th>5 μL</th> <th>10 μL</th> </tr> </thead> <tbody> <tr> <td></td> <td colspan="3" style="text-align: center;">($\mu\text{L}/\text{sec}/\text{tube}$)</td> </tr> <tr> <td>Low</td> <td>50</td> <td>120</td> <td>140</td> </tr> <tr> <td>Medium</td> <td>60</td> <td>140</td> <td>160</td> </tr> <tr> <td>High</td> <td>64</td> <td>160</td> <td>180</td> </tr> </tbody> </table> <p>RAD technology: Single-channel cassette flow rates match the standard cassettes and the 8-to-1 cassette matches the 10 μL flow rates. When dispensing 0.5 μL with the 1 μL cassette the average flow rate values are:</p> <table border="1"> <thead> <tr> <th>1 μL Cassette</th> <th>0.5 μL Dispense</th> </tr> </thead> <tbody> <tr> <td></td> <td style="text-align: center;">($\mu\text{L}/\text{sec}/\text{tube}$)</td> </tr> <tr> <td>Low</td> <td>52</td> </tr> <tr> <td>Medium</td> <td>54</td> </tr> <tr> <td>High</td> <td>56</td> </tr> </tbody> </table>	Cassette Type	1 μL	5 μL	10 μL		($\mu\text{L}/\text{sec}/\text{tube}$)			Low	50	120	140	Medium	60	140	160	High	64	160	180	1 μL Cassette	0.5 μL Dispense		($\mu\text{L}/\text{sec}/\text{tube}$)	Low	52	Medium	54	High	56	High
Cassette Type	1 μL	5 μL	10 μL																														
	($\mu\text{L}/\text{sec}/\text{tube}$)																																
Low	50	120	140																														
Medium	60	140	160																														
High	64	160	180																														
1 μL Cassette	0.5 μL Dispense																																
	($\mu\text{L}/\text{sec}/\text{tube}$)																																
Low	52																																
Medium	54																																
High	56																																
	Cassette type require	To require a specific cassette type for this protocol. If yes, select the type, if no, select ANY. See Peri-pump Settings to learn more.	ANY																														

Step	Option	Description/Values range	Default values
	d?:		
	Plate type:	Select the plate type, and optionally, limit the columns dispensed to. For high density plates, skipping certain "Rows" sections is supported, see 8-Channel Dispenser Dispense Pattern on page 139 .	96
	Position:	X- and Y- horizontal axes, Z- height (vertical) axis can be adjusted to improve performance. X- and Y- axes default to 0 steps for all plate types.	Z = plate type dependent
	Pre-dispense:	Also called "tip priming," pre-dispense normalizes the tips to ensure precise fluid distribution. Pre-dispense is recommended for most applications. Set volume and number of pre-dispenses, except, when dispensing 0.5 μ L, the volume is preset: 0.5 μ L for 4 cycles by default.	10 μ L 2 cycles
Purge		To preserve fluid in the tubing by pumping it back into the supply vessel, i.e. reverses the flow direction.	
	Volume:	1-3000 μ L	300
	Duration:	1-300 seconds	3

Note: *Half-microliter (0.5 μ L) dispensing requires a 1 μ L cassette. The Cassette Requirement Mode behavior is implemented whenever a 0.5 μ L volume is requested. Make sure a 1 μ L cassette is installed and the Cassette Type setting matches it. Only a 0.5 μ L dispense volume can be requested, not 1.5 or 2.5 μ L, for example. Perform two dispense steps, one for the half microliter and another at a full increment to achieve these volumes.

Important: Remember that the Peri-pump, the Syringe dispenser and Washer manifolds travel on the same dispense arm. Keep this in mind when adjusting the Z-axis or Dispense Height of any dispenser. A too low setting can cause a dispenser to crash into the plate.

 Uninstall the dispense cassette, if it is not required by a protocol, to prevent collisions when trying to position the Syringe or Wash dispenser as close as possible to the wells. And/or, consider increasing the **Plate Clearance Height** setting to increase the travel height.

Syringe Dispenser Parameters

Step	Option	Description/Values range	Default values
Prime			
	Flow rate:	1-5 (See dispense step description below)	5
	Volume:	80-8000 μ L. To remove air from the tubing.	5000
	Syringe:	A or B	A
	Cycles:	Number of prime cycles to perform	2
	Pump delay:	0-5000 msec.	0
		When dispensing highly viscous fluids, the tubing's check valves perform more slowly. Delaying the syringe pump sufficiently to allow the specified amount of fluid to pass through the check valves before being pumped into the syringe has been shown to improve dispense accuracy. Begin by setting the delay to 500 msec. Experiment with different settings to determine the optimal value for your fluid.	
	Submerge tips:	To soak dispense tubes in the priming fluid for a specified duration for cleaning or maintenance purposes. If yes, set duration, up to 24 hours, in minutes. See Syringe Prime Step on page 161 to learn more.	0
Dispense			
	Flow rate:	Rates 1-5 are dependent on the volume and plate type, except for 1536-well plates. See below.	2
	Dispense Volume:	5-30,000 μ L depending on the plate type.	10
	Syringe:	A or B or Both	A
	Columns:	Select the plate type, and optionally, limit the columns dispensed to.	96
	Pump delay:	(Same as Prime step description above.)	
	Position:	X- and Y- horizontal axes, and dispense height (Z- or	

Step	Option	Description/Values range	Default values
		vertical axis) can be adjusted to improve performance. Default values are plate type dependent, and position the manifold at least 1 mm above the plate.	
	Pre-dispense:	When enabled, dispenses into the priming trough immediately before filling the plate. Pre-dispense is recommended for most applications. It normalizes the tips to ensure precise fluid distribution. Set volume and number of pre-dispenses.	10 μ L 2 cycles

Syringe Dispenser Flow Rates:

Rates are volume and plate-type dependent:

For example, rate 1 must be used when dispensing between 10-19 μ L to a 96-well plate. When dispensing 20-49 μ L to a 96-well plate, you can use rates 1 or 2. And, when dispensing 50-59 μ L to a 96-well plate, you can use rates 1, 2, or 3. And so on, as shown in these tables.

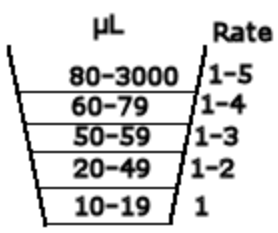
96-well plate		16-Tube	8-Tube
	Volume (μL)	Rate	μL/sec/well
80-3000	10-19	1	450
60-79	20-49	1-2	600
50-59	50-59	1-3	750
20-49	60-79	1-4	900
10-19	80-3000	1-5	1000

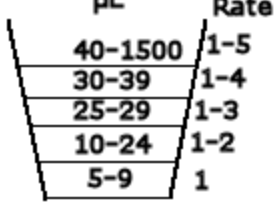
384-well plate		Volume (μ L)	Rate	μ L/sec/well
	40-1500	5-9	1	225
30-39	10-24	1-2	300	
25-29	25-29	1-3	375	
10-24	30-39	1-4	450	
5-9	40-1500	1-5	500	

■ Note: For 16-channel syringes the μ L/sec/well rate accounts for 2 tubes/well when addressing 96-well plates and one tube/well for 384-well plates.

1536-well plate			
Volume (μL) 3-3000 The 32-tube manifold flow rates do not have minimum volumes. The $\mu\text{L}/\text{sec}/\text{well}$ for each type of manifold, Small Bore (SB) and Large Bore (LB), is shown:	Rate	SB	LB
	1	56	125
	2	58	150
	3	60	162
	4	62	174
5	64	187	
The default rate is 3.			

Low-density-plate manifolds

Like the standard manifolds described above, for these plate-type-specific manifolds the flow rate is defined as $\mu\text{L}/\text{sec}/\text{well}$ and the minimum volumes are cumulative, i.e. any rate can be used to dispense Rate 5's minimum.

Manifold	Flow/Minimum Volume	Rate 1	Rate 2	Rate 3	Rate 4	Rate 5
6-Well	Flow	560	836	1116	1400	1680
	Min Vol	40	80	200	240	320
12-Well	Flow	420	627	837	1050	1260
	Min Vol	30	60	140	160	220
24-Well	Flow	280	418	558	700	840
	Min Vol	20	40	100	120	160
48-Well	Flow	279	372	560	600	800
	Min Vol	40	80	200	240	320

Wash Parameters Table

See [Protocol Parameters Tables on page 103](#) for Peri-pump and Syringe Dispenser parameters. See [Plate Types Table on page 9](#) for default Z-axis values or dispense heights.

Minimally, a wash step includes an aspirate step followed by a dispense step. Select and define each option to customize the parameters for your assay.

Option	Description/Values range	Default values
Number of wash cycles	Each wash cycle first aspirates and then dispenses fluid to and from the plate.	3
Aspirate		
Travel Rate	The rate at which the washer manifold travels down into the wells. The selection range is 1 to 5 for non-cell-based assays, from slowest to fastest. With these rates, the tubes slow their descent as they approach the defined aspirate height (Z Position) to aid complete evacuation of the well.	3
	For delicate, cell-based assays, the range is 1CW (cell wash) to 4CW and 6CW. These rates minimize turbulence in the wells. The tubes descend at a constant rate to the specified height. Rate 6CW creates the least disturbance and performs fastest.	
Delay	Amount of time the tubes stay at the aspirate height before lifting out of the wells. Define a delay between 0 - 5000 ms. Increasing the delay may improve evacuation of the wells.	0
Positioning	X- and Y- horizontal axes, Z- height (vertical) axis can be adjusted to improve performance. The default Z-axis setting is plate dependent. See Z-Axis: Default Dispense and Aspirate Heights .	Z = 91 for 96-well plates; X & Y = 0
Secondary aspirate	Also called Crosswise Aspiration. First, the wells are aspirated using the position defined above. The aspirate tubes rise and then descend to the secondary position to aspirate again. Employ this option to improve evacuation.	No
Final Aspirate	A final aspiration is the last action performed to completely evacuate the wells. Same parameters as regular aspirate step.	Yes
Dispense		
Flow Rate	The rate at which the fluid is dispensed from the tubes. For cell-based assays, use rate 1 or 2 for gentle washing. For normal dispensing, the range is 3-11, 3 is slowest and 11 is fastest.	5
Volume	µL/well dispensed: See Washer Flow Rate on page 111 .	Plate type specific

Option	Description/Values range	Default values					
Positioning	X- and Y- horizontal axes, Z- height (vertical) axis can be adjusted to improve performance. See Z-Axis: Default Dispense and Aspirate Heights .	Z = 336 for 96-well plate X & Y = 0					
Vacuum Delay	Suspends the vacuum pump until a certain volume is dispensed. This feature is critical to cell wash operations. It delays normal aspiration until the specified volume has been dispensed to the wells. The range is 0 to 30,000 $\mu\text{L}/\text{well}$.	0					
More Options							
Pre-dispense	Quick, small prime to condition the tips before dispensing.	No					
Bottom wash	Bottom washing adds an initial wash cycle to the specified number of cycles. Fluid is simultaneously dispensed and aspirated to create cleaning turbulence (at the specified height). The manifold descends to aspirate again and ends with a final dispense to fill the wells.	No					
Between cycles:							
Shake	To mix the contents of the plate.	No					
Duration	From one second to one hour.	5 sec.					
Intensity	<table border="1"> <thead> <tr> <th>Intensity</th> <th rowspan="4">Variable cycles through the other levels of intensity</th> </tr> </thead> <tbody> <tr> <td>Slow</td> </tr> <tr> <td>Medium</td> </tr> <tr> <td>Fast</td> </tr> </tbody> </table>	Intensity	Variable cycles through the other levels of intensity	Slow	Medium	Fast	Medium
Intensity	Variable cycles through the other levels of intensity						
Slow							
Medium							
Fast							
Soak	Delays wash for the duration to allow fluids in the plate to steep or incubate.	No					
Duration	From one second to one hour.	30					
Home carrier	To perform the shake or soak in the home position or not. But, the plate carrier is moved home when the total duration of the shake and/or soak exceeds 1 minute. The vacuum pump is turned off in this scenario. Moving the plate home prevents contaminating it with drops from the manifold.	No					
Pre-dispense between cycles	To wet or condition the manifold tubes between cycles, which is only needed after a long soak.	No					

Option	Description/Values range	Default values
	Same parameters as regular pre-dispense.	
Wash format	Manner of processing large-format plates	Plate
Strip	Performs the entire wash step on one section of the plate before it moves to the next section.	
Plate	Performs each cycle on the entire plate before it starts the next cycle. All wells in the plate are aspirated, then dispensed to, and so on.	

Washer Flow Rates

The default setting for flow rates is 5, in the middle of the range. Rates increase from the slowest to fastest (11). Slower rates are recommended for viscous fluids. Rate 1 is designed for cell wash assays, causing the least disturbance in the wells.

	Rate	$\mu\text{L}/\text{tube}/\text{second}$
Cell Wash	1	123
Cell Wash	2	140
	3	210
	4	252
Default	5	279
	6	348
	7	422
	8	595
	9	643
	10	791
	11	992

Note that flow rates are per tube. Depending on the wash manifold and plate type there may be multiple tubes in a well.

Minimum Dispense Volumes ($\mu\text{L}/\text{well}$) per Manifold

Rate	96/384-well	6-well	12-well	24-well	48-well
1 CW	40	155	105	80	60
2	20	65	60	40	60
3	20	65	60	40	60
4	30	120	60	60	60
5	20	120	80	60	60
6	40	150	80	80	60
7	55	225	100	110	70
8	50	225	140	105	70
9	60	225	160	120	100
10	100	400	260	200	105
11	110	450	290	220	150

Aspirate Travel Rates

Rate	mm/sec	
0 CW	1.0	for 6-, 12-, 24-well plates
1	4.1 +1	Slowest
1 CW	4.1	
2	5.0 +1	
2 CW	5.0	
3	7.3 +1	Default rate
3 CW	7.3	
4	9.4 +1	
4 CW	9.4	
5	9.4 +2	Fastest
6 CW	14.7	Recommended rate for Cell Wash protocols

Rate	mm/sec	
7 CW	30.0	

CW rates are specially designed travel rates that minimize turbulence in the wells for [Cell Wash protocols](#). 6 CW is recommended for cell-based and magnetic-bead assays. Alternatively, use 7 CW if loosely adherent cells are damaged by rate 6 CW, to further reduce turbulence in the wells. Expect a larger residual volume in the wells when using rate 7 CW. **Exception:** choose rate 0 CW when using 6-, 12-, and 24-well plates.

Standard rates (1-5) show two speeds as they approach the well because they slow down to 1 or 2 mm/sec before reaching the aspirate height to provide more time to aspirate the fluid, improving evacuation. Conversely, the CW rates do not change speeds, they move into and out of the well as quickly as possible to limit turbulence.

Pre-Dispense

Wash and Dispense Step option

Also called **Tip Priming**.

About the Pre-Dispense Options

Enable the Pre-dispense options to condition or normalize the dispense tubes before dispensing fluid. This is recommended for precise dispensing to mitigate evaporation or any potential fluid imbalance at the ends of the tubes.

The pre-dispense options are not intended to fully prime the tubing, for example, when changing fluids. Be sure to fully **Prime** the device to remove all air from the tubing before commencing a dispense step. Use the Pre-dispense feature to quickly prime the tubes or tips between runs.

When a Pre-dispense is enabled, the MultiFlo FX moves the plate to the home position to allow the manifold to dispense into the priming trough.

How to condition the tips before dispensing

- In a stand-alone **Dispense** step: select the [Advanced Options](#) link and fill the Pre-dispense checkbox;
- In a Wash step, select the [Show Wash Options](#) link and fill the Pre-dispense checkbox.

Minimum Prime Volumes for the Strip Washer

Flow rate:	Wash Manifold Type				
	6-Well	12-Well	24-Well	48-Well	96/384-Well
1	310	315	320	360	320
2	130	180	160	360	160
3	80	180	80	360	80
4	240	180	240	360	240
5	240	240	160	360	160
6	300	240	320	360	320
7	440	300	440	420	440
8	400	420	400	420	400
9	400	480	480	600	480
10	800	780	800	630	800
11	880	870	880	900	880

Bottom Wash

Bottom washing adds an initial dispense/aspirate sequence to the protocol. Fluid is simultaneously dispensed and aspirated to create cleaning turbulence (at the specified height). The manifold descends to aspirate again and ends with a final dispense to fill the wells.

Designed for strongly bound molecules in assays that require vigorous washing, e.g. ELISA, adding a bottom wash to the protocol has shown reduced background noise without increasing the number of wash cycles.

Adjust the Z-axis setting to position the manifold deep in the well to target the solid phase of coated assay plates.

Bottom Wash Volume: Enter the volume of wash solution to dispense per well during the bottom wash.

Flow Rate: Select a rate between 3-11 for best results. Cell wash options are designed for gentle washing, while bottom wash is designed for vigorous washing.

Advanced Options

Parameters	Description
Bottom Wash Height: Z-axis Position	The distance between the bottom of the aspirate tubes and the carrier surface. The value in mm is displayed on screen.
Horizontal X-axis Position	The left and right position of the dispense tubes when the carrier is beneath the manifold.
Horizontal Y-axis Position	The front-to-back carrier position (or Y axis) to align the microplate with the manifold tubes during a dispense.
Delay start of Vacuum	until dispensing this volume.

Change the Plate Type

Edit a protocol to change its plate type:

1. Select **Protocols** at the home screen.
2. Highlight the protocol and press **Edit**.
3. Press the **Info** button on the step definition screen and touch the **Plate Type** field to change the plate type.
4. Press **OK** to save the change. Press **Save** at the step definition screen to save the protocol.

Rename a protocol

There are two ways to rename a protocol, edit the name or make a copy and rename the copy. The MultiFlo FX behaves like Windows' Save As function, creating a copy of the protocol file when it is renamed.

To change the protocol name:

1. Select **Protocols** at the Home screen.
2. Highlight the protocol and press **Edit**.
3. Press **Info** and touch the **Name** field.
4. Press **OK** and **Save** the protocol when you're done.

You can delete the originally named protocol to [remove it from the Home screen](#).

Shake/Soak Step Parameters

Shake/Soak

Select the action to perform:

- **Move** carrier to home position first.
Regardless of selection, the plate carrier is moved home during a stand-alone shake step and when the total time of the shake and soak durations exceeds 1 minute. The vacuum pump is turned off in this scenario. Moving the plate home prevents drops from contaminating the plate.
- **Shake** settings:
 - **Duration:** enter numeric values to shake the plate for up to 1 hour.
 - **Intensity:** use the drop-down list to select a shake intensity. "Variable" cycles through the other levels of intensity.

Choose the intensity that most closely matches your assay kit instructions.



Magnetic Bead Assays: Set the shake intensity to **Slow** when using a magnet on the plate carrier.

- **Soak:** allows buffer/dispense fluid to remain in wells for the specified duration, i.e. processing is delayed:
 - **Duration:** enter values to stop processing the plate for up to 1 hour (59 minutes, 59 seconds).

■ Soak is not the same as "submerge" the tips. You must define a prime step or use the AutoPrime feature to soak the tips in the priming trough.

■ Soak is equivalent to incubating the plate at room temperature or delaying the protocol.

■ Shaking and soaking the plate is also an option when defining a Wash step.

Repeat steps in a Loop

Add a **Loop** to the protocol to repeat one or more steps a fixed number of times. The Loop is a step container. First, add the Loop step to the protocol and then put the action steps between the loop start and end steps.

How to use a Loop:

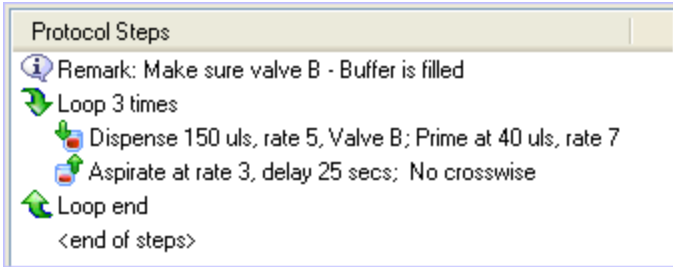

1. Highlight a step or <end of steps> placeholder and select the **Loop** button,
2. Enter the number of times to perform the steps in the loop. The **Loop # times** start and **Loop end** steps are added, with the end step highlighted.
3. Add the steps and define their parameters.
4. When all the protocol steps are defined, select **Validate** to make sure the instrument can perform them.
5. Save the protocol.

Make sure the steps to be performed are inside the Loop's start and end steps.

Delay the Protocol

Use this control to temporarily delay the procedure. It adds a delay step to your protocol. You can set:

- an indefinite delay, which must be manually ended during operation;
- a fixed duration or timed delay, which can be manually overridden when necessary;
- or, for more precise control, a timer to launch a protocol step. This "timer activated" delay lets you apply a uniform processing time to each plate in a multi-plate run.

Delay Type

Indefinite: to delay the procedure until the operator manually restarts the run. A message box will open with a **Continue** button. Any **Prompt** text will be displayed on-screen. The run will be paused until the operator clicks **Continue**.

Fixed-duration: to pause the protocol for a certain length of time. Specify the delay duration in the time control. At the start of the delay, a message box will open with a **Continue** button and any **Prompt** text. The operator can override the delay at any time by clicking the **Continue** button. Otherwise, the protocol will not resume until the specified time has expired. The maximum length of a fixed delay is 23:59:59 (23 hours, 59 minutes, 59 seconds).

Timer-activated: use this option to control the start time of a protocol step. This option is most useful in complex protocols that use the BioStack or another robot to process multiple plates. You can make sure that each plate is processed at a precise time.

Delay Behavior

Sound alert at start of delay: de-select this option to silently display the message box at the start of the delay. The audio volume is controlled under **Instrument>Preferences**. It chimes one time only at the start of the delay concurrent with an opening message.

Prompt: enter text, if desired, to display in a message box that opens during runtime at the start of the delay.

Timer Activated Delay

To gain precise control over your chemistry in complex protocols, consider using the **Timer Activated** delay option to specify when to launch a protocol step. You can make sure processing time is the same for every plate, to ensure, for example, that reagent remains in every plate for a minimum or uniform time period.

This is especially beneficial when designing a multi-step BioStack protocol that is run with varying numbers of plates in the stack. If the timer is not used in this scenario, assay performance could be significantly different in a run of 30 plates versus a 10-plate run.

■ **Important:** if the timer activated interval elapses before the steps in the step container are completed, there will be no delay, i.e. all steps will be executed without timed control.

A Timer-Activated Delay puts start and end steps in the protocol, similar to the BioStack loop. To remove the delay from the protocol, you must delete both steps.

Examples:

■ These examples show protocols for an EL406 Washer Dispenser, but the same principles apply to the MultiFlo FX.

Simple Delay

To use the timer successfully, you must first determine the approximate duration of your protocol steps. Specify a sufficient time lapse to both complete the steps and to delay the process to suit your assay.

When a 'timer activated' delay is defined, Delay start and end events are added to the protocol. The start and end events create a step container, similar to a Loop or BioStack run.

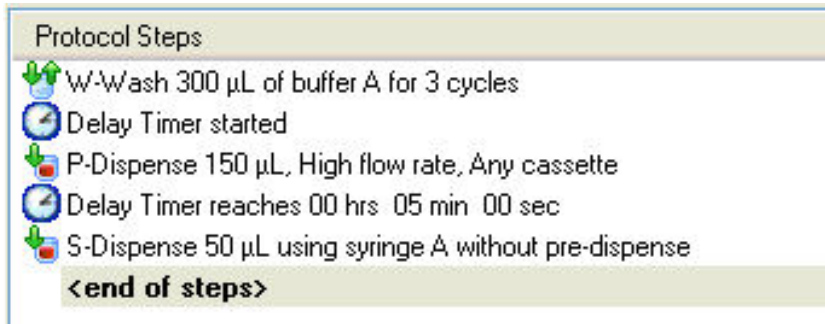

The example above shows how to manage the start time of two sequential operations, or steps. In this example, the timer is started prior to the Peri-pump dispense operation and ended prior to the Syringe pump dispense operation. The specified 5-minute delay is much longer than the duration of the Peri-pump dispense operation.

Nested Delays

The timer activated delay can be nested within another time controlled series of protocol steps. This may be necessary to specify multiple processing start times for a complex series of steps, including loops and BioStack steps.

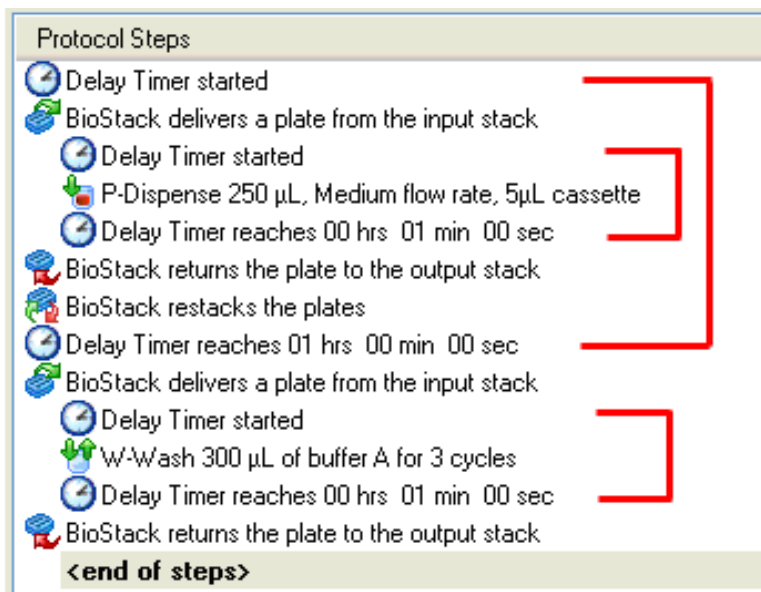

This example uses a BioStack rack of plates. The process requires that each plate in the rack be filled with 250 μ L from the Peri-pump and then, after 1 hour, the plate is washed. The protocol will fill each plate in the rack, restack the plates, and then wash each plate 1 hour after it was filled. The dispense and wash activities are each

performed within a 1 minute processing window created by the timers. This timer configuration ensures that the timing of washing after dispensing is identical for every plate.

Once again, make sure there is sufficient time to process all the steps within the step containers, and to incorporate any desired incubation or rest periods when defining the timer-activated time period.

RUN: Running Predefined Protocols

BioTek provides numerous predefined protocols for maintaining the instrument in top condition and for qualifying its performance. Review the [Predefined Protocols on the facing page](#).

To run a defined protocol:

LHC	Touch screen
<ol style="list-style-type: none">  Select Open and locate the MultiFlo FX folder. Open the MultiFlo FX folder to access the more folders. <p>Important: Be sure to Customize the Predefined Protocols below</p>	<ol style="list-style-type: none"> Touch a protocol on the Home or Maintenance screen to select it. Press Start to run it.

LHC Users Only: Customize the Predefined Protocols





BioTek provides predefined protocols for maintenance routines and instrument qualification tests. You can quickly customize the protocols for regular use.



The LHC keeps track of the last-used COM port for an instrument type. For example, when an EL406 runs a protocol, the LHC logs the COM port used and the next time an EL406 is used, the LHC applies the same COM port setting. You can disable this feature by defining your **Ports** preference: select **Tools>Preferences>Ports**.

To correct the COM port for the current protocol, click the **Port** link and use the drop-down list to select the correct value. The LHC stores the COM port value in the protocol file.

With the MultiFlo FX connected to and communicating with the host computer (i.e. make sure the instrument is turned on and not busy):

1.  Click the **Open** button, locate the **MultiFlo FX** folder and click **Open**.
2. Open the **Maintenance** or other folder and select the desired protocol.
3.  Change the COM port if necessary: click **Port** and enter the correct value or select from the drop-down list.
4.  Click **Settings**, which opens the Instrument Settings dialog.
5. Under **Get settings from:** click the **instrument** link.
6.  Click **Validate**.
A "Validation successful" message is displayed unless the protocol cannot be run on your instrument. See [LHC Protocols Explained](#).
7.  Save the protocol.

Predefined Protocols Listing

Maintenance Protocols

Daily Maintenance	Description
W-DAY_RINSE	Simple one-step protocol to fully flush the system with water or reagent to keep the manifold tubes clog-free. 40 mL total volume.
S-DAY_RINSE_A&B	Two-step protocol to flush tubing for both syringe pumps, (A & B). 40 mL per syringe. Similar protocols with one step for each individual syringe are also provided: S-DAY_RINSE_A or_B.
P-#UL_CASS_RINSE	Where # matches the cassette type in use and RAD refers to RAD technology cassettes. Simple one-step protocol to flush Peri-pump tubing. (P2 protocols are for the secondary Peri-pump.)
W-OVERNIGHT_LOOP	Protocol designed to keep the manifold in a wetted condition overnight or for a long downtime period; manifold tubes are submerged in fluid for 4-hour intervals between primes in this virtually endless loop.
W-RINSE_AND_SOAK	Identical to W-DAY_RINSE with one addition, the manifold tubes are submerged and soaked for 5 minutes in the fluid.

Periodic Maintenance

W-Decontaminate	Two stage protocol to decontaminate the washer, first flushing lines with disinfectant and then rinsing them with deionized or distilled water. Prompts guide the user through the process.
-----------------	---

Periodic Maintenance	
S-Decontaminate	Includes prompts for first running disinfectant and later running water through the system. It can be easily modified to suit any major cleaning effort. The A or B suffix identifies the syringe the protocol is designed for.
W-LONG_SHUTDOWN	Helps implement the recommended procedure for preparing the instrument for storage. This protocol includes prompts for running disinfectant, then water, and lastly, air through the system.
S-LONG_SHUTDOWN	Prepares the instrument for long-term storage. This protocol includes prompts for running disinfectant, then water, and lastly, air through the system. Defined to use Syringe A or B.
W-PRIME_40	Simple prime routine.

QC (Quality Control) Protocols

Manifold-Specific	
QC_96_DISP_TEST	Dispense precision test protocol for 96-well wash manifold.
QC_96_EVAC_TEST	Evacuation efficiency test protocol for 96-well wash manifold.
QC_SA-1536_DISP_TEST	Dispense precision test protocol for 32-tube Syringe A manifold.
QC_SB-1536_DISP_TEST	Dispense precision test protocol for 32-tube Syringe B manifold.
QC_P-1536_DISP_TEST	Dispense precision test protocol for Peri-pump 1 μ L cassette and 1536-well plate. (P2 protocols are for the secondary Peri-pump)

Predefined Sample Protocols

The "Sample" protocols are provided to facilitate learning. Some samples are model specific. "P2" protocols are copies of the primary protocol but defined for the Secondary Peri-pump.

LHC users: You may need to customize the protocols ([as described on page 120](#)) to match your instrument's settings.

Serial dilutions	
P-96_DILUTION	Peri-pump serial dilution protocol dispenses 20 μ L to 240 μ L in 20 μ L increments to each column of the plate. 20 μ L to column 1; 40 μ L to column 2; 60 μ L to column 3; and so on till 240 μ L to column 12.

P-384_ DILUTION	Serial dilution protocol dispenses 2 μ L to 94 μ L in 2 μ L increments to each column of the plate. 2 μ L to column 1; 4 μ L to column 2; and so on till 94 μ L to column 24.
S-96_ DILUTION	Syringe dispenser serial dilution protocol dispenses 240 μ L to 20 μ L in 20 μ L increments to each column of the plate. 240 μ L to column 1; 220 μ L to column 2; 200 μ L to column 3; and so on till 20 μ L to column 12. Defined for Syringe A.
S-384_ DILUTION	Serial dilution protocol dispenses 98 μ L to 6 μ L in 4 μ L increments to each column of the plate. 98 μ L to column 1; 94 μ L to column 2; 90 μ L to column 3; and so on till 6 μ L to column 24. Defined for Syringe A.
Cell Wash	
W&P-96_ CELL_WASH	Cell wash-dispense protocol uses the special low-flow tubing, optimal dispense and aspirate heights, and vacuum delay during the wash step. Following the wash, the Peri-pump dispenses 200 μ L to each well.
Microplate Manufacturers	
W- COSTARFLAT	Standard wash protocols modified to best position the manifold tubes for dispensing and aspirating to Corning Costar flat-bottomed and round-bottomed wells.
W-COSTAR_ ROUND	
W-NUNC_384	Standard wash protocols modified to best position the manifold tubes for dispensing and aspirating to Nunc [®] flat-bottomed wells, round-bottomed wells, and 384-well plates.
W-NUNC_FLAT	
W-NUNC_ ROUND	
RAD Technology Peri-pump Cassettes	
P_RAD-96	100 μ L/well Peri-pump dispense using a single-tube RAD cassette to partially fill a 96-well plate, hit-picking wells to spell "RAD." Begins with two 20 μ L/tube pre-dispenses.
P_RAD-384	50 μ L/well Peri-pump dispense using a single-tube RAD cassette to partially fill a 384-well plate, hit-picking wells in a pattern that represents the BioTek logo. Begins with two 10 μ L/tube pre-dispenses.
P_RAD 8Tube- 24	1120 μ L/well Peri-pump dispense using the 8-to-1 RAD cassette to partially fill a 24-well plate, dispensing to each corner well and 4 wells in the center. Tip Tracking is enabled with an initial Z-axis of 5.08 mm. The chute is positioned to direct the fluid stream to the well walls with an X-axis offset of 2.97 mm.
Note: duplicate protocols defined for the Secondary Peri-pump have a P2 prefix.	

Operating with the BioStack

If you purchased BioTek's BioStack Microplate Stacker to operate with the MultiFlo FX, here is some important information about running it:

Touch Screen Control:

- The Quick Wash and Quick Dispense options do not function with the BioStack, i.e. the BioStack will not deliver a plate. You must create a protocol to process plates using the BioStack. Touch screen protocols must contain a BioStack loop.
- You can use the Quick Wash and Quick Dispense **Prime** options. This is recommended especially prior to processing plates, to remove air from the tubing.
- To process plates with lids (a BioStack4 feature), you must have a **Lid Definition** file that precisely matches your plate and lid type, and you must enable this option when defining the protocol (not at runtime).

LHC Control:

- LHC users: connect both the BioStack and the MultiFlo FX to the computer and control them with the LHC.
- Design protocols that integrate BioStack controls with MultiFlo FX steps. LHC protocols must contain a BioStack loop.
- In the LHC, select **Help>Tutorials**, click **Sections** in the toolbar for a drop-down menu, select **Controlling the Bio-Stack with LHC**. It only takes a couple minutes to complete this interactive demo. It is a great way to learn about the special BioStack features offered with the LHC.

Install and Align the BioStack:

1. Set up the BioStack according to instructions in your BioStack Operator's Manual to interact with the MultiFlo FX. Connect the BioStack to the:
 - Host computer (PC) when using the LHC to control the MultiFlo FX.
 - MultiFlo FX when using the touch screen for instrument control.
2. Align the BioStack's gripper with the MultiFlo FX's plate carrier:

LHC:	Touch screen:
<ol style="list-style-type: none"> 1. Select Tools> BioStack Utilities. 2. Use the Alignment Utility. Click the Help button for detailed instructions. 	<ol style="list-style-type: none"> 1. At the Home screen, select Instrument>Next>BioStack. 2. Fill the BioStack installed checkbox. 3. Press BioStack Alignment to launch this utility.

3. Set the BioStack operating mode:

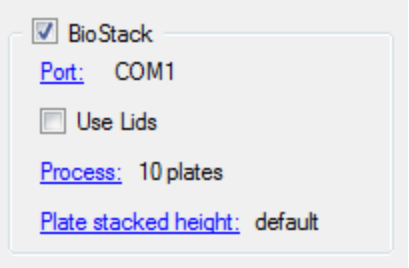
LHC:	Touch screen:
	<p>When controlling the BioStack with the instrument and not processing plates with lids, you can choose to run the whole stack or a specific number of plates at runtime: use the BioStack controls on the run screen.</p>
<p>Fill the BioStack checkbox in the main view to enable the BioStack action buttons and use them to design a protocol that delivers and retrieves plates.</p>	<p>Note: Both methods, LHC and touch screen, require a BioStack-enabled protocol to run the staker.</p>

4. **Verify** the setup: perform a protocol with 1 or 2 plates. [See How to define a BioStack protocol below.](#)

 At the start of the day, power up the BioStack first, and then the MultiFlo FX. BIOSTACK2WR: Lift the BioStack’s gripper before turning it on.

 Robotics integrators: CAD drawings of the physical dimensions of the MultiFlo FX are available upon request. Contact BioTek customer service.



Technical Note: Only one of the two communication ports (COM port) on the instrument can be used at a time. They cannot be used simultaneously. You can use USB to connect the MultiFlo FX to the computer or the RS232 serial port to connect to a BioStack or similar robotic device. But you cannot use both ports simultaneously, i.e. make sure only one cable is plugged in at a time.

Use the BioStack

How to define a BioStack protocol

- Select Instrument>Next>BioStack and fill the installed checkbox to enable the BioStack steps.

Like the [Loop](#), the BioStack command is a step container. First, add the [BioStack](#) step to the protocol and then put the action steps inside the BioStack start (deliver plate) and end (return plate) steps. Here's an example:

1. Highlight a step or the <end of steps> placeholder and press **Add** and then **BioStack**. This adds a start step, BioStack delivers and an end step, BioStack returns plate. The end step is highlighted.
2. Press the desired action button and define the parameters of the steps to be performed on each plate.

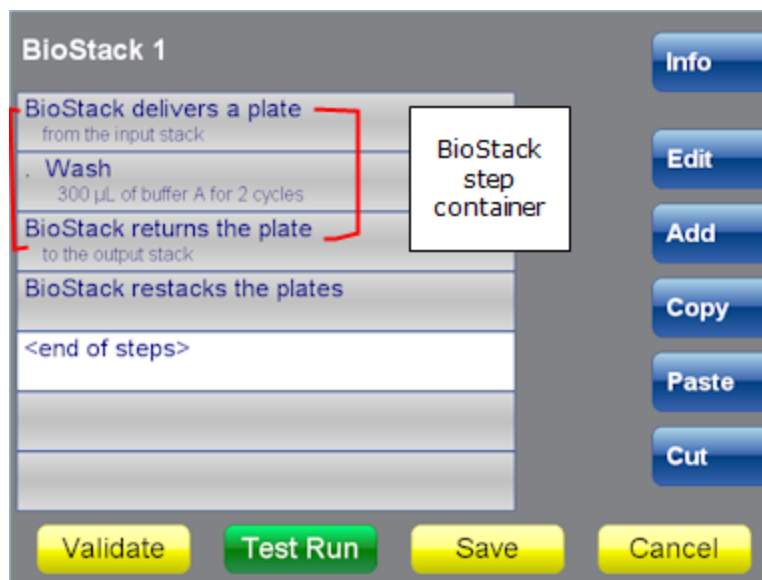

Make sure the steps to be performed on the plates are inside the 'BioStack delivers' and 'BioStack returns' steps.

3. Optionally, highlight the <end of steps> placeholder, press **Add** and add a **Restack** step to move the plates back to the input stack. A **Restack** step must be outside the BioStack step container.
4. When all the protocol steps are defined, click **Validate** to make sure the protocol is correctly designed.
5. Save the protocol.
6. At runtime, except when using plates with lids, you can define the **Number of plates to process** in the **Run Info** section of the run screen: enter a specific number or select the "Entire input stack" for processing.

How to run plates with lids

1. Select the **Info** button and fill the checkbox to **Use Lids**.
2. Select a file in the **Lid Type** field that most closely matches your plate type. (Touch screen: press the field to select a file.) (Select **View definition** to see the file's details.)

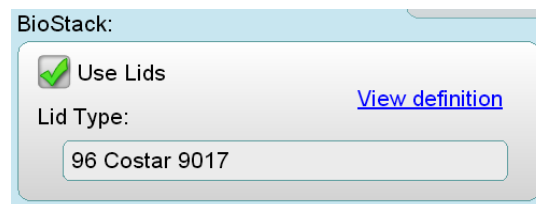

Conversely, de-select **Use Lids** to process plates without them.

Typically, the BioStack will work perfectly using one of the [Plate Lid Definition](#) files provided by BioTek. Review the list to find one that matches your lids. If, however, you do not find a match or you experience problems when transferring plates or lids, create your own files. Use calipers to precisely measure the dimensions of the plates and lids to be processed. Refer to the BioStack Operator's Manual when creating your own files.

Re-stack plates in the BioStack

After the plates in the input stack have been processed, they are moved to the output stack. The **Restack** step moves them back into the input stack in their original order.

Important: The **Restack** step must be outside the "BioStack" step container and it must follow a container. Only plates previously processed in a BioStack loop can be re-stacked.

Nth Plate to perform special process

- The Nth Plate feature is only available when using the BioStack (and plates without lids). And, the Nth Plate step must be put inside a **BioStack** step container.
- To precisely time the events in a BioStack run, also consider the Delay option: [Timer Activated Delay on page 118](#).

About the Nth Plate

Read [About the Nth Plate step](#), if you haven't already done so. See Also: [Advanced Plate Sequencing with the BioStack](#) for more details and to see examples.

How to define the Nth Plate Steps

Remember to consider the placement of the Nth Plate block in relation to non-special steps. When you want a special function to occur after a certain number of plates have been processed, put the Nth Plate block after that step in the **BioStack** block. Otherwise, determine the optimal sequencing of the Nth Plate and regular steps.

The MultiFlo FX will perform the regular BioStack steps on all plates until the specified Nth plate is reached, then, it will perform the Nth Plate steps. When you want to perform a special function on the Nth Plate or before the Nth Plate has been processed, put the Nth Plate block before the regular step.

1. Highlight the "BioStack" end step or the step that the Nth Plate block will precede and select the **Nth Plate** button. This adds start and end steps, with the end step highlighted.

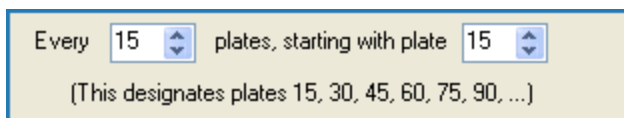

2. Define the start plate and how often to repeat the special procedure.
3. Use the checkboxes to:
 - **Run only the Nth Plate steps:** fill the checkbox to perform only the steps in the Nth Plate block (step container) at the designated plate. Leave the checkbox blank to perform all the protocol steps on the Nth plate, i.e. both the Nth Plate steps and the protocol steps that follow the Nth Plate block and precede the next Nth Plate block or BioStack end tag.
 - **Remove plate before running steps:** to perform the Nth Plate steps without a plate. Alternatively, de-select the checkbox to perform the steps on the designated plates.
4. Click an action button and define the parameters for the "Nth Plate" steps to be performed. Make sure the steps are within the Nth Plate start and end tags.
5. Click **Validate** to make sure the protocol syntax is correct.

 Add a **Delay** step to the protocol/Nth Plate steps to allow time during processing to put a special plate, like a priming plate, on the instrument or to do another manual task.

About the Nth Plate Step

- The Nth Plate feature is only available when using the BioStack (and plates without lids). And, the Nth Plate step must be put inside a **BioStack** step container.

When using the BioStack, the Nth Plate feature lets you perform a special function, like dispensing blanks, after a certain number of plates have been processed or to specify special processing for certain plates in the stack. The MultiFlo FX identifies the special plate or plates (that we call Nth plate) by counting the number of plates that have been processed before it.

You can limit the action, when the Nth Plate is reached, to perform only the "Nth Plate steps." In this case, the Nth Plate steps can be performed with or without an actual plate. Another option is to perform all the steps in the protocol, both regular and Nth Plate steps, when the Nth Plate is reached.

The Nth Plate step is a step container, similar to the Loop and BioStack step containers. First, you add the Nth Plate step to the protocol and then put the action steps inside its start and end tags. We call this grouping an Nth Plate block.

For the designated plates, you choose between performing only the Nth Plate steps or performing both the Nth Plate steps and the protocol steps that follow the Nth Plate block (and precede the next Nth Plate block). This means you must consider the placement of the Nth Plate block in relation to the regular protocol steps when designing a complex protocol. For simple actions, like performing a maintenance step after a certain number of plates have been processed, make the Nth Plate Block the last step in the BioStack step container. All the plates will be processed the same way and then the instrument will perform the maintenance action.

For more complex processing, remember that the steps are performed in ordered sequence beginning with the first step in the BioStack block. When the first step is an Nth Plate block, the MultiFlo FX can evaluate it to determine which plates will be handled in a special way. Any steps that precede an Nth Plate block will be performed on all plates, including the Nth designated plates.

Multiple Nth Plate blocks can be defined in a protocol to sequentially perform a series of varying actions on a specified grouping of plates.

Advanced Plate Sequencing with the BioStack

Read [About the Nth Plate Step on the previous page](#), if you haven't already done so.

- To precisely time the events in a BioStack run, also consider the Delay option: [Timer Activated Delay on page 118](#).

Numerous scenarios can be served using these special features, here are a few examples:

- Use an Nth Plate step to flush the tubing or perform a maintenance task after a certain number of plates have been processed.
- Use a series of Nth Plate or BioStack steps to test the number of wash cycles required for optimal assay performance.
- Use a series of Nth Plate or multiple BioStack steps to perform a serial dilution on recurrent groups of plates: dispense 200 μL to the first plate, 150 μL to the second, and 100 μL to the third.

The BioStack step block creates groups of like-processed plates. The Nth Plate lets you create a mixed group of plates that have been processed with different parameters. For example, using three Nth Plate steps you can process a stack of

plates to stagger the dilutions, as shown in the table below. Similarly, three BioStack step blocks can result in a stack of plates sorted into dilution groups.

Using a series of Nth Plate or BioStack step blocks we can dispense 100 μL to plates in the first pass, 200 μL to plates in the second pass, 300 μL in the third pass. Choose the method that matches your preference for sorting the plates in the stack:

Group	Plate	Nth Plate	Use BioStack
A	1	100 μL	100 μL
	2	200 μL	100 μL
	3	300 μL	100 μL
B	4	100 μL	200 μL
	5	200 μL	200 μL
	6	300 μL	200 μL
C	7	100 μL	300 μL
	8	200 μL	300 μL
	9	300 μL	300 μL

Use an Nth Plate step to perform maintenance

Certain fluids, like BSA, can clog the liquid handler's dispense tubes, so flushing the tubes after dispensing to a certain number of plates is recommended for optimal performance. When using the BioStack you can use the Nth Plate step to add a maintenance routine to the protocol.

Here's an example of using the Nth Plate step to perform an AutoClean loop after every 15 plates have been washed. The Nth step is defined this way:

Every plates, starting with plate

(This designates plates 15, 30, 45, 60, 75, 90, ...)

Protocol Steps

- Bio-Stack delivers a plate from the input stack
- Every 15 plates, perform these replacement steps
 - Autoclean for 1 loop
 - Nth plate end
- Wash x3 with 300 μL , rate 5, Valve B; Aspirate rate 3; ...
- Bio-Stack returns the plate to the output stack
- <end of steps>

- Run only Nth Plate steps is checked.
- Remove plate before running steps is checked.

AutoClean will occur after 15 plates are washed, after 30 plates are washed, and so on.

Use a series of BioStack steps

When using the BioStack you can treat plates in a non-uniform manner by defining a series BioStack step blocks. You can, for example, determine the optimal number of wash cycles required for an assay.

Don't forget to define the "Number of plates to process" for all the BioStack loops in the protocol. Enter the number of plates at runtime or when defining the protocol.

In this example we create groups of like-processed plates. The stack will contain in this sequence: 5 plates with 5 cycles, 5 plates with 4 cycles, 5 plates with 3 cycles, and 5 plates with 2 cycles. The plates in the BioStack's output stack will be sorted this way:

Plates	# Wash Cycles
1	5
2	5
3	5
4	5
5	5
6	4
7	4
8	4
9	4
10	4
11	3
12	3
13	3

The screenshot shows the BioStack configuration window. At the top, there is a checkbox labeled "Use Bio-Stack" which is checked. Below it, the "Port" is set to "COM7". Under "Number of plates to process:", there is an unchecked checkbox for "entire input stack" and a spinner box set to "5" plates. Below this is a section titled "Protocol Steps" which lists the following steps:

- Bio-Stack delivers a plate from the input stack
- Wash x5 with 300 uls, rate 5, Valve A; Aspirate r
- Bio-Stack returns the plate to the output stack
- Bio-Stack delivers a plate from the input stack
- Wash x4 with 300 uls, rate 5, Valve A; Aspirate r
- Bio-Stack returns the plate to the output stack
- Bio-Stack delivers a plate from the input stack
- Wash x3 with 300 uls, rate 5, Valve A; Aspirate r
- Bio-Stack returns the plate to the output stack
- Bio-Stack delivers a plate from the input stack
- Wash x2 with 300 uls, rate 5, Valve A; Aspirate r
- Bio-Stack returns the plate to the output stack

The list ends with "<end of steps>".

14	3
15	3
16	2
17	2
18	2
19	2
20	2
21	1
22	1
23	1
24	1
25	1

Alternatively, [Use Nth Plate steps](#) to create mixed groups of plates, where each group contains a plate with 5 wash cycles, a plate with 4 wash cycles, a plate with 3 wash cycles, and so on.

Serial Dilutions Examples

Nth Plate: To generate mixed groups of dilutions in the stack of plates, as depicted in the table below, three Nth Plate steps are used. The entire stack can be processed this way.

Protocol Steps	Plate	Volume
Bio-Stack delivers a plate from the input stack	1	100 µL
Every 3 plates, run only these Nth Plate steps	2	200 µL
Dispense 100 uls, rate 5, Valve A; No prime	3	300 µL
Nth plate end	4	100 µL
Every 3 plates, run only these Nth Plate steps	5	200 µL
Dispense 200 uls, rate 5, Valve A; No prime	6	300 µL
Nth plate end	7	100 µL
Every 3 plates, run only these Nth Plate steps	8	200 µL
Dispense 300 uls, rate 5, Valve A; No prime	9	300 µL
Nth plate end	10	100 µL
Bio-Stack returns the plate to the output stack	11	200 µL
<end of steps>	12	300 µL
1st Nth Plate: Every 3rd plate starting with 1		
2nd Nth Plate: Every 3rd plate starting with 2		
3rd Nth Plate: Every 3rd plate starting with 3		

BioStack steps: To generate three distinct dilution groups in the stack of plates, as depicted in the table below, three "BioStack" steps/step containers are used.

	Volume	Plate
	100 µL	1
	100 µL	2
	100 µL	3
	200 µL	4
	200 µL	5
	200 µL	6
	300 µL	7
	300 µL	8
	300 µL	9

Plate Types and Processing Patterns

Depending on the type of hardware installed on the instrument, e.g. manifold type, the MultiFlo FX can process several plate types. The default parameters for wash and dispense steps represent the optimal positioning of the hardware for the plate type. And, the aspirate and dispense heights and horizontal positions can be adjusted when necessary for special situations and to optimize assay performance.

- Review the [Plate Types Table on page 9](#) for a listing of supported plates and their geometries;
- **See [Dispense Processing Patterns on page 138](#)**
- Review these instrument settings that may improve your work flow:
 - Plate Carrier Setting
 - Plate Clearance Setting
 - Dispense Pattern

Handling Special Plates and Mini-tubes

Note: Also see the [Plate Types Table on page 9](#).

- [Peri-pump Special Plate Handling below](#)
- [Mini-Tube Racks on page 137](#)

1536F - 1536-well Flanged Plates

Important: Crashes can occur! Remove unused manifolds when dispensing to 153F plates.

To prevent an unused Peri-pump cassette or Syringe manifold from colliding with the plate flange during dispensing:

- use **both** Syringe manifolds simultaneously, and,
- unload the Peri-pump cassette when it is not being used;
- alternatively, remove the Syringe manifolds while using the Peri-pump;
- limit protocols to one dispenser only, either the Syringe or Peri-pump, i.e. run multiple protocols on a plate when the assay requires using more than one device.

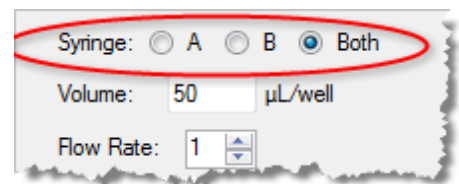

To achieve the best dispense performance when processing 1536-well flanged plates, the MultiFlo FX's default protocol settings specify a low dispense height to position the dispense tubes as close as possible to the wells. When the dispense arm holds multiple dispense manifolds, the manifolds not addressing the wells can collide with the plate flanges during a dispense.

Peri-pump Special Plate Handling

Note: Applies to non-RAD cassettes only, i.e. standard 8-channel cassettes.

The **Peri-pump** supports several plate types, but vessels with fewer than 8 rows require special handling. Some adjustment of or consideration of how the 8-channel dispense head will address the plate is needed.

The Peri-pump's **dispense volume is per tube or channel**, not per well. This is the most important fact to consider when using these special plates. The volume defined in a Quick Dispense or protocol is the amount each tube will dispense to the well.

When you use multiple tubes to address a well, specify the desired volume with this multiple in mind. For example, two tubes can address each well in a 24-well plate, so the "defined" volume must be half the desired volume. As always, be sure to also consider the [Peri-pump's optimal performance](#) settings when designing the dispense protocol, i.e. full aliquots are more accurate than fractions of an aliquot.

Another tool to consider using with special plates is the X- or Y-axis Dispense Position setting. You may be able to use it to aim the dispense tubes to a certain region of the well.

6-, 12-, 24-, and 48-Well Plates

When addressing these plates with the Peri-pump, BioTek recommends experimenting with different dispense-tube-to-well configurations. For some plates, multiple tubes can dispense to a single well. Conversely, dispense tubes can (and sometimes, must) be removed from the supply vessel or from the cassette to prevent them from missing the wells.

Testing at BioTek found the following capabilities:

Plate Type	Columns/Rows	Tubes per Well	Tubes removed
6 Well	3 x 2	3 or 4	(4 and 5) or 0
12 Well	4 x 3	2	3 and 6
24 Well	6 x 4	2	0
48 Well	8 x 6	1	3 and 6

- **6-well plates** with 2 rows: three or four tubes can fit in the wells. Remove tubes 4 and 5 to use just three tubes per well. Fewer tubes may be preferred to preserve cells in certain assays.
- **12-well plates** with 3 rows: two tubes can fit in the wells, so 6 tubes will be used. Remove tubes 3 and 6.
- **24-well plates** with 4 rows and large enough wells to support two tubes are the easiest of these special plates. All 8 tubes can be used, 2 per well, for standard microplates. Exception: the special [24-vial rack, PN 7212058](#), requires removing the even numbered tubes from the cassette or fluid supply.
- **48-well plates** with 6 rows: requires two tubes, 3 and 6, to be removed.

■ Remember, when defining a run: **dispense volume is per tube**, not per well. Divide the desired volume by the number of tubes in a well.

 If you regularly use 6- or 48-well plates, which require dispense tubes to be removed from the fluid supply before dispensing, you should consider dedicating certain cassettes for the purpose. Removing the unused tubes from the cassette, rather than from the fluid supply, will preserve them for future use and make the cassette easier to handle. Review the instructions to [Replace Peri-pump Dispense Cassette Tubing on page 210](#).

Special Plate Carrier for Mini-tubes



An optional accessory for the MultiFlo FX, a special plate carrier is needed to support certain special vessels, like a box of mini-tubes. (PN 7212042)

96 Mini Tubes is the [Plate Type](#) name we give to Corning® 96 Well Cluster Tubes (PN: 4410, 4411).

Special 24-Vial Rack

To dispense to the mini-tubes the special plate carrier must be installed to accommodate the extra height. You can also use the carrier for other oversized vessels that may not otherwise be addressed by the dispensers by increasing the [Plate Clearance](#) setting. The maximum height supported with the combination of special carrier and Plate Clearance is about 49-50 mm.

To install the special carrier:

1. Remove the standard carrier: loosen the thumbscrew on the left side of the carrier to release the little support arm and lift the carrier up and off the transport rails.
2. Orient the special carrier so the small cavity for the support arm is on the left, align the hollows under the carrier with the transport rails, and install the carrier.

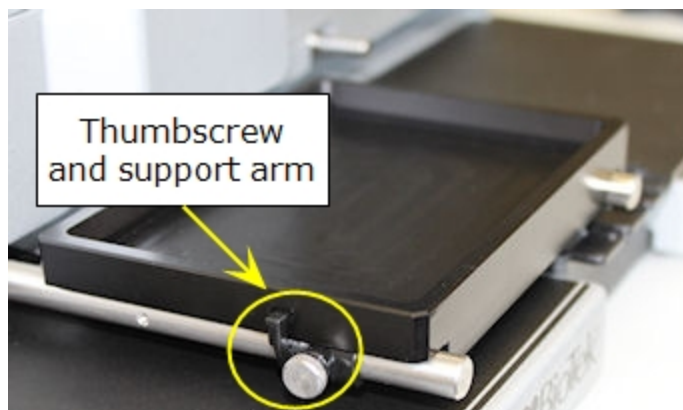

3. Change the [Plate Carrier](#) setting to match the currently installed plate carrier:

- [Change the Plate Carrier Setting \(Touch screen\) on page 169](#)
- [Change the Plate Carrier Setting \(LHC\)](#)

Mini-Tube Racks

The MultiFlo FX supports a special mini-tubes rack, which is available from BioTek as an accessory item:

- 96 Mini-Tubes, in standard 12 column x 8 row format

Before dispensing to the mini-tubes, install the [Special Plate Carrier for Mini-tubes on the previous page](#) provided for this vessel. You can use the Peri-pump and 8- and 16-tube Syringe dispensers to fill the mini-tubes.

■ Note: Position adjustments in the Y-axis are prohibited with the special plate carrier for mini-tubes.

Dispensing to Mini-Tubes

Unlike most dispensing with the MultiFlo FX, the fluid stream does not hit the center of the well or tube when dispensing to the mini-tubes using the [special plate carrier](#). This image illustrates where the fluid stream is positioned depending on the type of dispenser used:

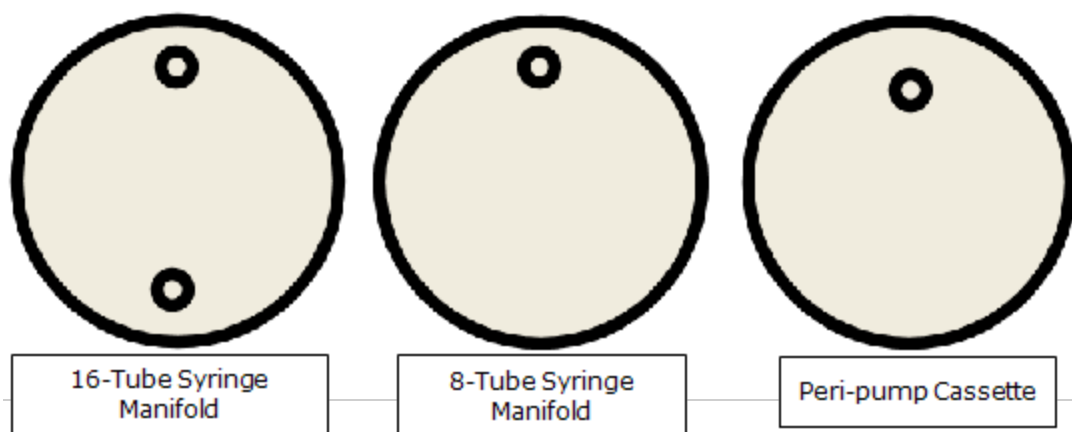

Two tubes address each mini-tube when using the 16-tube Syringe manifold. For the 8-channel devices, one channel per mini-tube is engaged.

■ Note: Position adjustments in the Y-axis are prohibited with the special plate carrier for mini-tubes.

Dispense Processing Patterns

When dispensing to high-density plates, 384- and 1536-well, 8-channel dispensers, like the (non-RAD) Peri-pump cassettes and certain Syringe dispensers, employ a dispensing pattern that permits filling only a portion of the plate, skipping some sections.

- 8-channel dispensers include the Peri-pump, 96/384-well Wash manifold, and the 8-tube Syringe dispenser manifold.

Columns



To skip an entire column toggle the radio button off. With this feature you can dispense to odd columns in one dispense step, change fluids or use another dispenser and dispense to even columns in another dispense step.

Rows



8-channel dispensers offer another way to control the dispense pattern to high-density plates. See [8-Channel Dispense Patterns](#).

32-Tube Syringe Dispenser Manifolds

One 32-tube dispense manifold addresses one column at a time. When both 32-tube manifolds are used simultaneously, they align with every 5th column, in a pattern like this:

Columns												
1				5				9				13
	2				6				10			14
		3				7						
			4				8				and so on...	
Syringe A				Syringe B								

Columns 1 and 5 are dispensed to first, then columns 2 and 6, 3 and 7, and so on.

8-Channel Dispenser Dispense Pattern

When addressing high density plates, 384- and 1536-well, the 8-channel cassette/syringe dispenser moves in the pattern described here to fill the plate. With [Advanced Dispense Options](#), you can skip certain rows and columns.

The MultiFlo FX let's you specify which columns to skip during a dispense step.

384-Well Plate

Rows: You can skip one of the two "rows" sections:



	1	2	3	4	5	6	7	8	9	10	11
1a	1	1	1	1	1	1	1	1	1	1	1
2b	2	2	2	2	2	2	2	2	2	2	2
3c	1	1	1	1	1	1	1	1	1	1	1
4d	2	2	2	2	2	2	2	2	2	2	2
5e	1	1	1	1	1	1	1	1	1	1	1
6f	2	2	2	2	2	2	2	2	2	2	2
7g	1	1	1	1	1	1	1	1	1	1	1
8h	2	2	2	2	2	2	2	2	2	2	2
9i	1	1	1	1	1	1	1	1	1	1	1
10j	2	2	2	2	2	2	2	2	2	2	2
11k	1	1	1	1	1	1	1	1	1	1	1
12l	2	2	2	2	2	2	2	2	2	2	2
13m	1	1	1	1	1	1	1	1	1	1	1
14n	2	2	2	2	2	2	2	2	2	2	2
15o	1	1	1	1	1	1	1	1	1	1	1
16p	2	2	2	2	2	2	2	2	2	2	2

When an 8-channel dispenser addresses a 384-well plate, it first dispenses to odd numbered rows, and then dispenses to even numbered rows. With this feature you can dispense to odd rows in one dispense step, change fluids or use another dispenser and dispense to even rows in another dispense step.

In addition, you can combine a selection of columns with one of the two row sections (odd or even) to define a complex distribution pattern.

1536-Well Plate

Rows: You can skip up to three "rows" sections:



	1	2	3	4	5	6	7	8	9	10	11	12
①	1	1	1	1	1	1	1	1	1	1	1	1
2	2	2	2	2	2	2	2	2	2	2	2	2
3	3	3	3	3	3	3	3	3	3	3	3	3
4	4	4	4	4	4	4	4	4	4	4	4	4
⑤	1	1	1	1	1	1	1	1	1	1	1	1
6	2	2	2	2	2	2	2	2	2	2	2	2
7	3	3	3	3	3	3	3	3	3	3	3	3
8	4	4	4	4	4	4	4	4	4	4	4	4
⑨	1	1	1	1	1	1	1	1	1	1	1	1
10	2	2	2	2	2	2	2	2	2	2	2	2
11	3	3	3	3	3	3	3	3	3	3	3	3
12	4	4	4	4	4	4	4	4	4	4	4	4
⑬	1	1	1	1	1	1	1	1	1	1	1	1
14	2	2	2	2	2	2	2	2	2	2	2	2
15	3	3	3	3	3	3	3	3	3	3	3	3
16	4	4	4	4	4	4	4	4	4	4	4	4
⑰	and so on...											

When an 8-channel dispenser addresses a 1536-well plate, it first dispenses to rows 1, 5, 9, 13, 17, 21, and 25. The next section of rows dispensed to includes 2, 6, 10, 14, 18, 22, 26, and 30. And so on, creating 4 sections of rows.

Dispense Pattern with Both Syringes

When "Both" Syringe dispensers are selected to fill a plate, the manifolds move in this pattern:

Plate: 1536 Well Plate
 Syringes: Both Syringes
 Plate Map: All Columns

Column:	1 thru 12												13 thru 24												25 thru 36												37 thru 48																											
Syringe:	1	2	3	4	5	6	7	8	9	0	1	2	3	4	5	6	7	8	9	0	1	2	3	4	5	6	7	8	9	0	1	2	3	4	5	6	7	8	9	0	1	2	3	4	5	6																		
	A	A	A	A	B	B	B	B	A	A	A	A	B	B	B	B	A	A	A	A	B	B	B	B	A	A	A	A	B	B	B	B	A	A	A	A	B	B	B	B	A	A	A	A	B	B	B	B	A	A	A	A	B	B	B	B	A	A	A	A	B	B	B	B

Plate: 384 Well Plate
 Syringes: Both Syringes
 Plate Map: All Columns

Column:	1 thru 12												13 thru 24											
Syringe:	1	2	3	4	5	6	7	8	9	0	1	2	3	4	5	6	7	8	9	0	1	2	3	4
	A	A	B	B	A	A	B	B	A	A	B	B	A	A	B	B	A	A	B	B	A	A	B	B

Plate: 96 Well Plate
 Syringes: Both Syringes
 Plate Map: All Columns

Column:	1 thru 12											
Syringe:	1	2	3	4	5	6	7	8	9	0	1	2
	A	B	A	B	A	B	A	B	A	B	A	B

Washer Operation

About the MultiFlo FX Wash Step

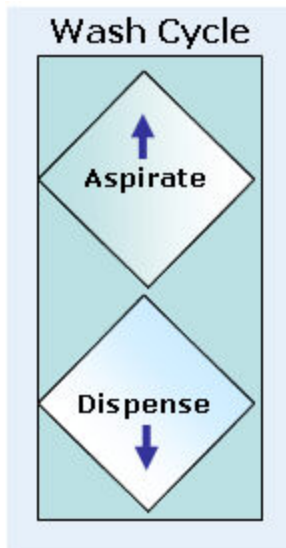

Minimally, a wash step includes an aspirate step followed by a dispense step. This is a **wash cycle**. The default definition of a wash step includes 3 cycles, followed by a final aspiration to evacuate the wells. It is important to prime the washer manifold before running a wash. You may also want to include a [Pre-dispense](#) or tip prime to correct for evaporation and other minor fluid loss to normalize the tips.

Overfill washing, which has proven effective for ELISA assays, is a popular feature: fluid is aspirated simultaneously to dispensing to prevent spillage by positioning the aspirate tubes at the tops of the wells.

About the hardware:

The wash manifolds are identified by the plate types they support, e.g. 96/384-well manifolds aspirate and dispense fluid to and from 96-well and 384-well plates. Likewise, the other manifold options are dedicated to a plate type:

6-well, 24-well, and so on. Manifold configurations vary to accommodate the geography of the plate; at times using multiple tubes in a well to accomplish the task.

Cell Wash

See how to [Define a Cell Wash Protocol below](#).

The MultiFlo FX supports cell-based assays that require the addition and removal of buffer solution without disrupting the cells in the wells of the microplate. Cells are often dislodged when fluid is dispensed at too high a pressure and lost during subsequent aspiration of the fluid from the well unless counter measures are taken.

When the Flow Rate is set to 1 or 2, the MultiFlo FX dispenses fluid to the wells slowly enough to avoid damaging the cells.

Additional Techniques

Delay Aspiration: Also critical to cell-based assays is delaying aspiration to allow the slower dispense process to finish before beginning fluid removal from the well. This option, offered as part of the dispense step, is called [Delay Start of Vacuum](#).



Adjust the Aspirate Travel Rate and Aspirate Height: when defining the aspirate step select one of the specially designed travel rates that minimize turbulence in the wells. Increase the aspirate height to leave more residual fluid in the wells to protect the cell layer. Also, consider using a secondary aspiration.

Adjust the Dispense Flow Rate, Height and Position: when defining the dispense step be sure to select one of the special Flow Rates, 1 or 2 CW. Also reposition the dispense tubes to aim the fluid at the side of the wells to further minimize turbulence. [See Cell Wash Strategies on the facing page](#).

Slow down the Plate Carrier: select **Instrument>General** and set the **Plate Carrier Speed** to Slow.

Define a Cell Wash Protocol

Adjust the volumes recommended in this procedure to meet your specific needs.

1.  Create a new protocol.
2.  Add a **Prime** step, especially when the lines are empty or when changing fluids.

3. W-Wash Add a **Wash** step and define it as you normally would, except with these special parameters:
- Set the Aspiration **Travel Rate** to **6 CW** and the **Delay** to **0**.
 - Set the Dispense **Flow Rate** to **1** or **2**.
- Select the Dispense **Advanced Options** link and enable the **Delay start of Vacuum** until sufficient fluid has been dispensed. For small dispense volumes, BioTek recommends setting the delay volume to equal your dispense volume.
 - Reposition the dispense tubes to aim fluid at the side of the wells to reduce turbulence and change the aspirate height to increase the amount of residual fluid left in the well to protect the cell layer. **See [Cell Wash Strategies](#) below.**



Be sure to check the parameters for Final Aspiration.

Cell Wash Strategies

To give you a starting point for optimizing your own assays, here are some recommendations for improving your cell wash assays:

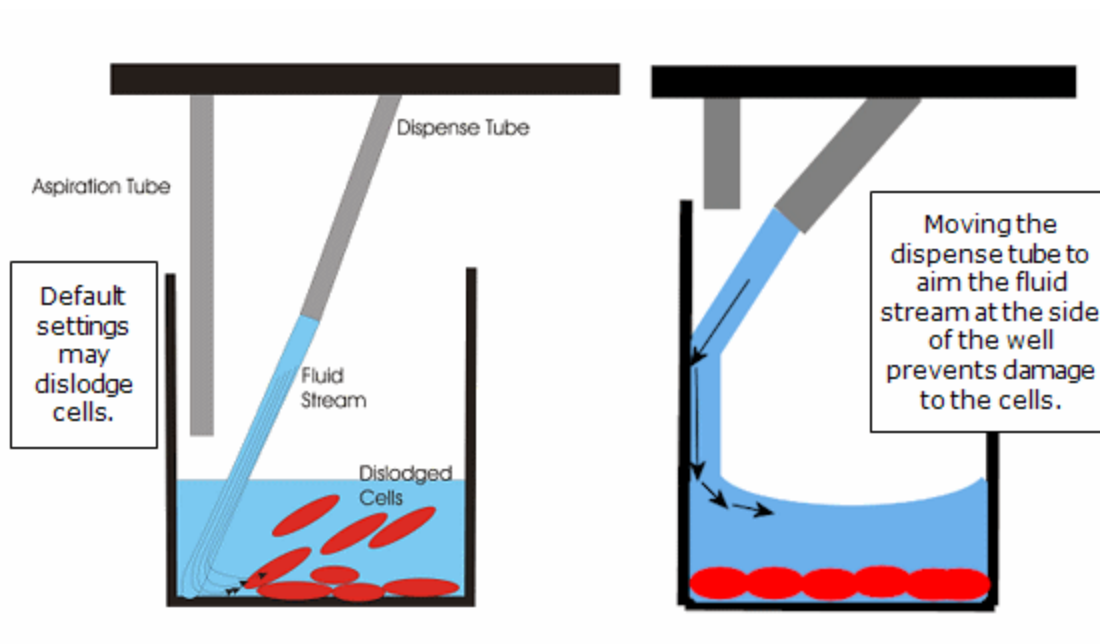

Repositioning the dispense and aspirate tubes helps minimize turbulence in the wells, preserving more cells.



For loosely adherent cells, the best performance was seen by increasing the aspirate height and using both a standard and secondary (or crosswise) aspiration. Moving the

aspirate tubes from one side of the well to the other prevents a fluid stream from forming and dislodging the cells. Increased residual in the well means increased cell retention.

Best practice:

- Use the Adjust Utility to determine the optimal X, Y, and Z axis adjustments needed to best position the manifold above the wells during the wash routine.
- Test the protocol settings by running the protocol using only water and an empty plate before actually running your assay to make sure the fluid stream hits the wells as desired.

Delay Aspiration or Vacuum-On Volume Control

Touch Screen: Edit the Wash or Dispense Step>Advanced Options

During regular plate washing, aspiration and dispensing occurs simultaneously. This allows "overflow" dispensing, because the fluid is aspirated before overflowing the plate.

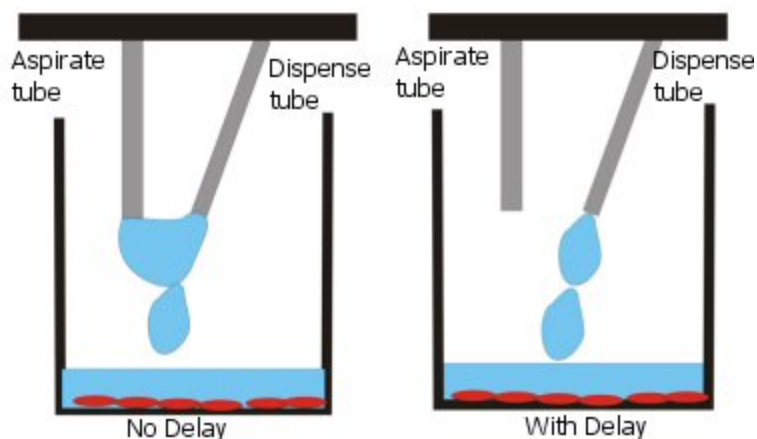

Use this control to begin aspiration only after the specified volume is dispensed. For cell wash assays, specify at least 10 μL /well. For small dispense volumes or to disable aspiration for the entire dispense duration, set the vacuum-on volume to equal your dispense volume. Refer also to application notes on the BioTek web site for more information (www.biotek.com).

Note: When the volume is set to 1120 μL /well or more, aspiration is disabled during the dispense step.

Biomagnetic Separation - Magnetic Bead Assays

The microplate carrier, when the magnet adapter is used, supports placement of a magnet under the microplate. The magnet induces magnetic beads to settle at the bottom of the wells to help retain them during a wash protocol's aspirate cycle.

The MultiFlo FX supports standard microplates and these magnets available for purchase from BioTek:

Plate Type	Magnet	PN
96-well	96 Flat Magnet	7103016
	96 Ring Magnet	7102216
384-well	384 Flat Magnet	7103017
	384 Ring Magnet	7102215

You can use a different magnet if it fits in the carrier and accommodates your plates. Contact BioTek TAC or visit the Customer Resource Center at www.biotek.com to obtain a drawing of the carrier with its dimensions.



Persons with pacemakers/implants should avoid direct contact. Keep all magnetic media, watches, and sensitive electronic devices away from the magnets. Credit cards, tapes, and disks can be erased in the presence of a magnetic field. Bodily harm [pinching of hands and skin] can result if magnets are not handled correctly. Maintain distance between two or more magnets.



Take advantage of the sample magnetic-bead protocols shipped onboard the MultiFlo FX. Copy W-Luminex_Mag_Flat_96, for example, and modify the parameters to suit your assay requirements.

Handling and Cleaning the Magnets

For best magnet strength and bead retention, the bottom of the microplate must be as close to the magnet as possible. We recommend using flat-bottom plates with minimal support “webbing” between the sides of the outer wells and the plate skirts.

Handle the magnets with care. Avoid direct contact with the magnet material. Keep loose ferrous material away and do not attempt to disassemble.

The magnet should be stored in a cool, dry environment and should be cleaned with a damp cloth and mild detergent when exposed to harsh solvents. Do not autoclave.

To install the magnet in the proper orientation:

- Flat magnet: place in the plate carrier adapter so the text on the side of the magnet is readable;
- Ring magnet: place in the plate carrier adapter with the small round magnets visible, facing upwards.

Realign the BioStack with the Magnet Installed

Using the magnet increases the effective height of the carrier surface (generally by at least 7 mm). This shift in the plate position requires a comparable adjustment to the BioStack's gripper movement. Realign the BioStack before using it with the magnetic bead assays.

Refer to the BioStack Operator's Manual for detailed instructions of the alignment procedure. To help get you started:

1. Place the magnet in the carrier and a microplate on top of it.
2. Launch the **BioStack Alignment Utility**:

LHC	Touch screen
Tools> BioStack Utilities> Alignment Utility	Instrument>Next> BioStack

3. HOME the BioStack and Begin Realignment.
4. Lower the claw until a 0.050" (1.3 mm) gap between the bottom of the plate and the top of the gripper fingers is achieved and save the gripper position.
5. Put the microplate in the input stack and Verify the alignment.



Remember to realign the BioStack for non-bead assays, when applicable.

Perform Magnetic Bead Assays

For the best results when performing biomagnetic separation assays:

- [Realign the BioStack with the Magnet Installed](#)
- Change the [Magnet Height Offset on page 150](#)
- [Optimize Magnetic Bead Protocols on the facing page](#)

Optimize Magnetic Bead Protocols

Here are some suggestions to consider for optimizing your magnetic bead assays:

- **Plate Type:** Flat-bottom plates are recommended for magnetic bead assays because more of their well surface sits closer to the magnet, resulting in increased magnet strength, than with other plate formats. If you must use round-bottom plates, increase the between-cycle soak time to improve bead separation during processing.
- **Magnet Adapter Height Offset:** Deploy this offset to increase the Z-axis or height setting in all processing options to accommodate the increased height of the magnet. **See Determine Magnet Height Offset.** Use of this feature may eliminate the need to "Adjust the Aspirate height" described below.
- **Shake/Soak Step:** Begin the protocol with a delay to let the magnetic beads settle. Also, specify a mid-cycle soak to let the beads settle after fluid is dispensed to the plate, e.g. include a 60 second soak before and between cycles.
- **6CW Aspirate Travel Rate:** select 6CW for the aspirate travel rate. The CW travel rates are designed to minimize disruption to cell layers on the bottom of the well. The same principle applies to magnetic bead assays.
- **Adjust the Aspirate height:** increase the aspirate height setting (Z-axis) which will increase the residual fluid in the wells but also preserve the beads. Good results were obtained when keeping the aspirate height around 15.0 mm above the plate carrier for all but a last Final Aspirate (disabled between cycles).
- **Adjust the Aspirate position:** When using [Flat Magnets below](#), position the aspirate tubes near the sides of the wells (X-axis), if possible, to improve bead retention.
- As always, before running assays, we recommend testing new protocols using deionized or distilled water and a little Tween[®] 20 with the desired microplate and a magnet installed.

Flat Magnets

Use this information about the flat magnets to fine-tune wash protocol settings:

96F Magnet	7103016
384F Magnet	7103017

The 96- and 384-well magnets are structured differently. Their force fields traverse the magnet in opposite directions. Magnetic beads in the wells will be drawn to the center. For the best bead retention, reposition the aspirate tubes in the proper axis:

96-well Flat Magnet PN 7103016

The magnetic force (approx. 6800 Gauss) is distributed in a horizontal pattern, row-wise, across the plate. Magnetic beads are pulled to the center, across the well in flat-bottom plates and to the button in round-bottom plates. Increasing the aspirate height to increase the amount of residual in the well may improve performance.

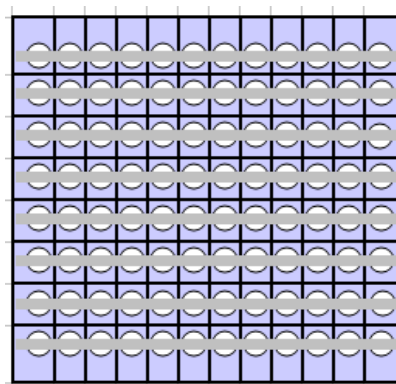
**Aspirate Settings:**

Adjust the Y Position to align the aspirate tubes near the well walls, if available. Increase the Aspirate Height (Z axis), leaving more residual volume in the wells.

**384-well Flat Magnet PN 7103017**

The magnetic force (approx. 4300 Gauss) is distributed in a vertical pattern, column-wise, across the plate.

Adjust the X Position to align the aspirate tubes away from the center of the well, near the well walls.

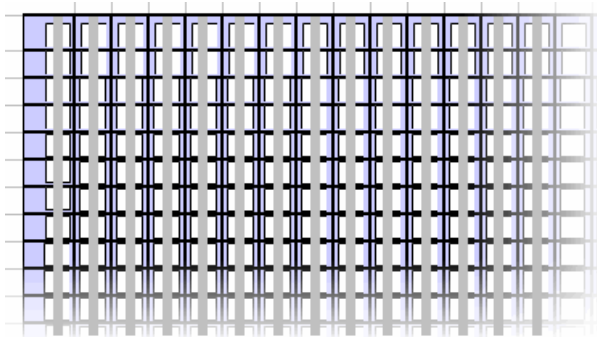

Ring Magnets

Use this information about the VP magnets to fine-tune wash protocol settings:

96 Ring Magnet	7102216
384 Ring Magnet	7102215

96 Ring Magnet

PN: 7102216

This magnetic bead separator uses 329 of VP's 52 MGO magnets (7094 Gauss). The magnets are arranged around each well, pulling the magnetic beads to the bottoms and edges of the wells. Aspirate from the center of the well (the default position), when using this magnet.

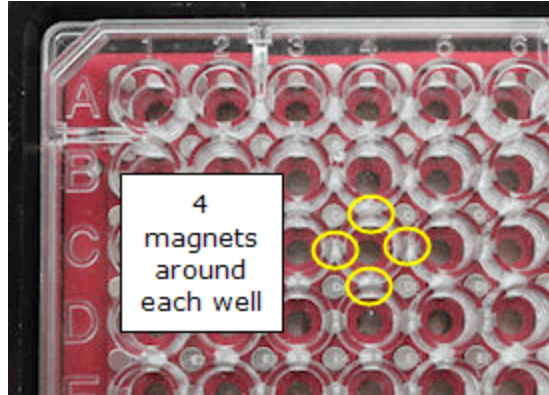
**384 Ring Magnet**

PN: 7102215

This magnetic bead separator uses 425 of VP's 52 MGO magnets (6994 Gauss). The magnets are aligned with the intersections of the wells, pulling the magnetic beads to the bottoms and edges of the wells. Every well is circled by 4 magnets.



Aspirate from the center of the well (the default position), when using this magnet.

How to determine the Magnet Adapter Height Offset

Use calipers for the best results or another measuring device.

1. Put a magnet in the adapter, and the type of plate you will be using in place on top of it.
2. Measure the distance from the bottom of the adapter to the top of the plate in millimeters (mm).
3. Remove the plate, and measure it alone.
4. Subtract the stand-alone plate measurement from the measurement value of the combined elements.
This is the value to use.

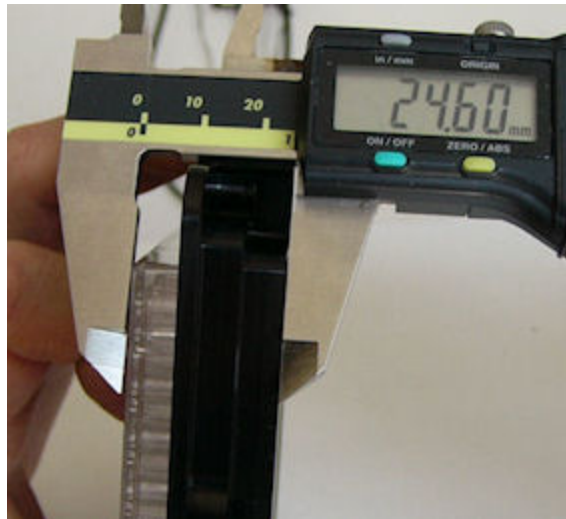
**Examples**

In our testing we found these offset values to be effective:

Plate Type	With	PN	Offset Value (mm)
96 Corning	Magnet Adapter	7180011 (kit)	8.73
	Dexter 96 Magnet	7103016	10.20
	VP 96 Ring Magnet	7102216	10.48
	VP 96 Magnet	7102217	10.18
384 Corning	Magnet Adapter	7180011 (kit)	8.73
	Dexter 384 Magnet	7103017	11.20
	VP 384 Ring Magnet	7102215	11.50

Magnet Height Offset

When performing magnetic bead assays/biomagnetic separation, this offset setting is a real time saver. It increases the height or Z-axis for all processing options to accommodate the increased height of the plate when the magnet is installed.

This setting eliminates the need to modify individual protocol parameters to adjust the dispense and aspirate heights and enables Quick Dispense and Quick Wash (without adjustments) when the magnet is used. It applies the specified height value as an offset to all relevant steps.

 Custom or non-standard microplates and special adapters for labware may benefit from this setting, too. If a vessel's height has been its only limitation to processing with the MultiFlo FX, i.e. the vessel's geometry permits the manifold tips to successfully address its wells, this setting can be used to simplify protocol development.

 For the best results, measure the height of the plate you are using with the magnet. BioTek has determined that Nunc flat bottom plates are about 3 mm taller than a similar Corning plate, for example.

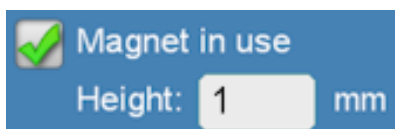

The "In use" checkbox/option lets you specify and retain a height setting. Set the value once and then use the control to switch it on and off: fill the checkbox when using a magnet, empty the checkbox to disable the offset.

LHC

1. Tools> **Instrument Utilities> General**
2. Fill the **In use** checkbox and set the **Magnet Adapter** height to the correct offset.
3. Click the **Send** link.

Touch screen

1. **Instrument >General**
2. Fill the **Magnet in use** checkbox and enter the **Height** offset value.
Remove the checkmark to turn off the offset.

Special Procedure for Magnetic Bead Assays

Before using the **Syringe Dispenser** or **Strip Washer** to dispense magnetic beads, you must remove the magnets that normally hold the dispense manifolds on the instrument. Two thumbscrews are shipped with the manifolds to replace the magnets.

1. Use the 1/16th hex wrench (PN 48713) to loosen the set screw on top of the manifold.
2. Take advantage of the magnet's attraction to the hex wrench to remove it from the manifold.
3. Locate the thumbscrews shipped with the instrument's accessories. After sliding both manifolds onto the dispense arm, put the screws into the post to hold the manifolds in place.

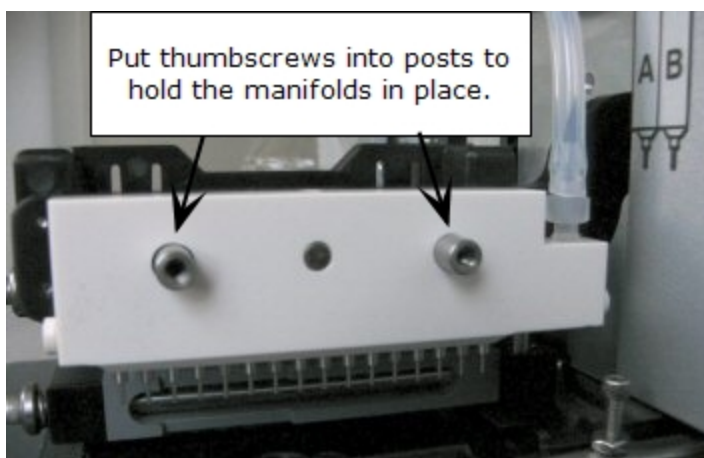
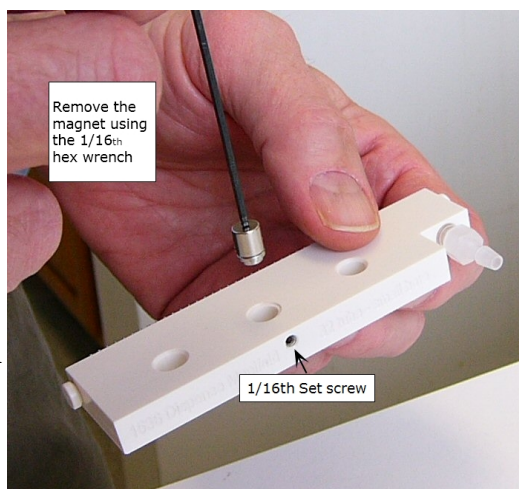

Peri-pump Peristaltic Dispenser

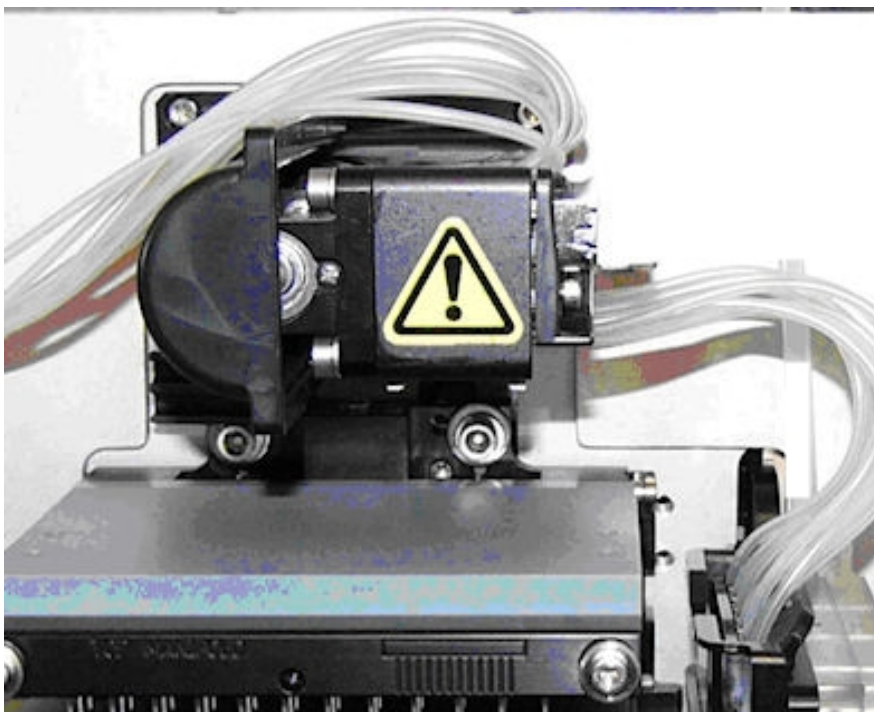

- Some models do not include a Peri-pump dispenser.

Quick Dispense-Prime-Purge

In addition to controlling the Peri-pump with defined protocol steps, the MultiFlo FX offers a Quick menu to Dispense, Prime and Purge fluid. (0.5 μ L dispensing is not available and RAD 8-to-1 bulk dispensing is not recommended when using the Quick menu; you must create a protocol for these features.)

Dispense Cassettes

- **Important:** It is imperative that the cassette type setting onboard the instrument match the installed cassette!

- [Install the Dispense Cassette on page 56](#)
- [Change the cassette type setting on page 76](#)
- [Dispense Cassette Diagram on page 54](#)
- [Release the tension on the dispense cassette on page 154](#)

Peri-pump: How it works

The Peri-pump component dispenses fluid using a peristaltic pump. It works by expelling a portion of fluid trapped between advancing rollers. The tubing is pinched by the rollers to form a full aliquot or **slug**.

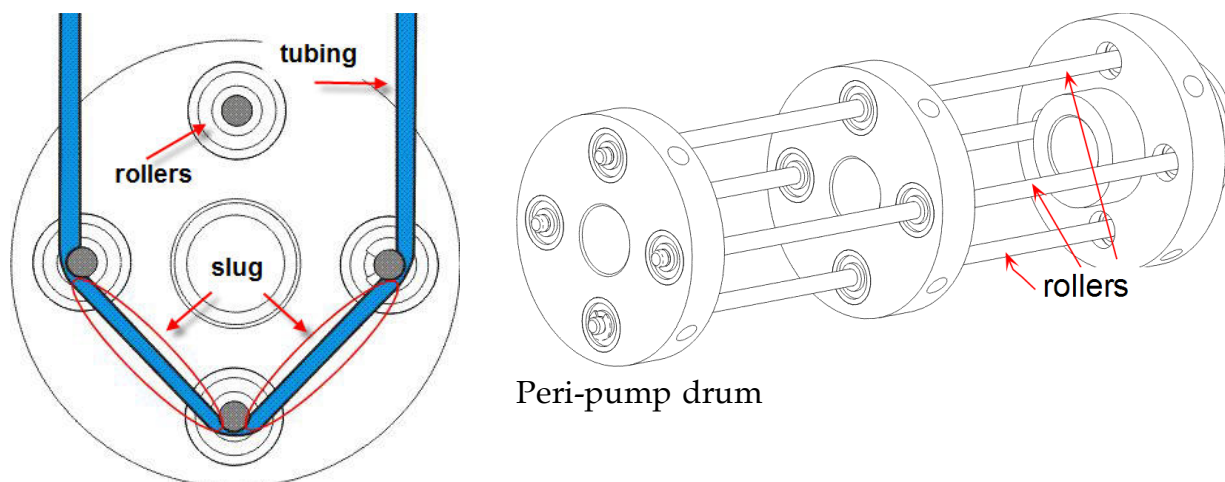

The volume of fluid in a single slug depends on the tubing size and linear distance between rollers. As the rollers spin, the fluid advances and is expelled at the tip in finite aliquots or slugs. The volume of each slug is the amount of fluid squeezed between two adjacent rollers.

The stepper motor turns the pump a determined number of steps. The pump drum can be advanced in smaller increments than the distance between rollers to expel a fraction of the full aliquot. However, the volume of the fractions is variable, depending as it does on many factors (exact rotor position, tubing tension, tip geometry, etc.). The variation between volumes of fractional aliquots is significantly higher than between dispenses done with full aliquots. Thus, **the best possible performance and reproducibility from dispense to dispense is done in full aliquot increments**. That is, specifying a 1 μL dispense volume when using the 1 μL cassette, 5 μL dispense volume when using the 5 μL cassette, and 10 μL dispense volume when using the 10 μL cassette. The exception is for instruments that support 0.5 μL dispensing. These late-model instruments apply an offset to the stepper motor to ensure precise and repeatable dispenses using a 1 μL cassette to dispense 0.5 μL aliquots, which is the only half increment permitted. Only a 0.5 μL dispense volume can be requested, not 1.5 or 2.5 μL , for example.

The tubing cassettes are calibrated by stretching the tubing to the size required to accurately dispense the expected volume per aliquot. BioTek calibrates cassettes to meet the **specifications** before shipping them. Over time the tubing's properties

will alter slightly, but the cassettes can be recalibrated to restore expected performance, in most cases.

- [See Performance Specifications on page 21.](#)
- [See Recalibrate the Peri-pump Dispense Cassette on page 211.](#)

Release the tension on the dispense cassette

 Important information about dispense cassettes!

When not in use, BioTek recommends releasing the tension on the cassette. This practice extends its life, preserving the tubing's integrity.

To release the tension:

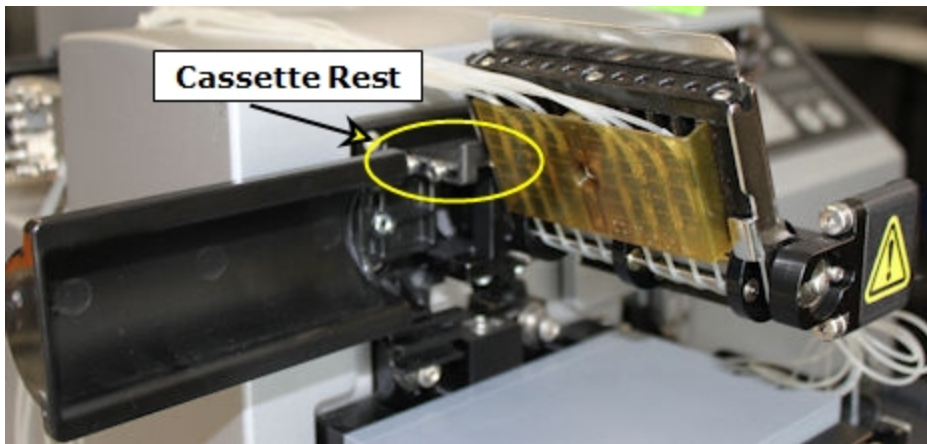

1. Open the **Pump Cover**.
2. Pull out the **Cassette Rest**.
3. Release the spring-loaded latch that holds in place the **Tube Tensioner** attached to the pump's stainless steel plate. It will rest against the cassette rest.

Peri-pump Dispense Step

P-Dispense

Add a Peri-pump dispense step to the protocol:

LHC

Click **P-Dispense** and define the parameters

Touch screen

Select **Add>P-Dispense** and define the parameters

- If applicable, select which Peri-pump to use, Primary or Secondary.
- If applicable, enable the [RAD technology](#) dispenser.

Define the Dispense Step

Dispense Volume: Enter the per well volume in microliters, up to 30,000/well. The recommended values for each cassette type are:

- 1 μL cassette = 1 - 50 μL or 0.5 μL
- 5 μL cassette = 5 - 2500 μL
- 10 μL cassette = 10 - 3000 μL

Note: When using the **RAD 8-to-1** bulk-dispensing cassette lower the dispense height to ensure fluid hits the wells, i.e. select Advance Options and change the Z-axis.

Select the **Flow Rate**

Cassette Type	1 μL	5 μL	10 μL
	($\mu\text{L}/\text{sec}/\text{tube}$)		
Low	50	120	140
Medium	60	140	160
High	64	160	180

RAD technology: Single-channel cassette flow rates match the standard cassettes and the 8-to-1 cassette matches the 10 μL flow rates.

When dispensing 0.5 μL with the 1 μL cassette the average flow rate values are:

1 μL Cassette	0.5 μL Dispense
	($\mu\text{L}/\text{sec}/\text{tube}$)
Low	52
Medium	54
High	56

Cassette Type Requirement

LHC/Touch screen

- Optionally, **Require (a) specific cassette** type to run this protocol.
 - Fill the checkbox to ensure users install the correct cassette type when running this protocol.
 - Leave the checkbox empty to allow any cassette type to be used.
 - For RAD technology cassettes choose both tubing and cassette type.

Note: Half-microliter (0.5 μL) dispensing requires a 1 μL cassette. The Cassette Requirement Mode behavior is implemented whenever a 0.5 μL volume is requested. Make sure a 1 μL cassette is installed and the Cassette Type setting matches it. Only a 0.5 μL dispense volume can be requested, not 1.5 or 2.5 μL , for example. Perform two dispense steps, one for the half microliter and another at a full increment to achieve these volumes.

Pre-Dispense

When enabled, the Peri-pump primes into the priming trough immediately before dispensing to the plate. Pre-dispense is recommended for most applications. It normalizes the tips, to correct for evaporation, for example, to ensure precise fluid distribution.

See [Protocol Parameters Tables on page 103](#) for details about the remaining parameters.

RAD Tip Tracking

When using the 8-to-1 bulk-dispensing cassette, you can further minimize the chance of disturbing cells in the bottom of a well using "tip tracking." When enabled, the chute or tip gradually rises as fluid is dispensed into the well.



Dispensing begins at the specified dispense height (Z-axis) and moves up to a maximum height that is equal to the [Plate Clearance](#) height.

Prerequisites:

- Tip Tracking must be enabled in [Instrument Settings](#)
- You must define a dispense protocol, i.e. do not use [Quick Dispense](#).
- The protocol's initial dispense height or Z-axis position must be lower than the default height.



Shortcut: Make a copy of the sample protocol: **P2 RAD**

STUBE-24, and modify it for your assay. As always, experiment with parameters to determine the optimal settings.

How to use **Tip Tracking**:

1. [Set the Cassette Type](#) to 5 µL: 8 tubes RAD and enable **Tip Tracking**.
2. Define a protocol using:
 - the external Peri-pump
 - a 6-, 12-, or 24-well plate
 - a Z-axis height 2-4 mm above the cells/well contents
 - an X-axis value that positions the tip chute as close as possible to the well wall

■ Use the **Align** utility to determine the X- and Z-axis.

3. [Install the bulk-dispensing cassette](#), and the plate and you're ready to run.



Important: Remove the priming trough inserts when using the 8-to-1 RAD cassette. The chute will collide with both the RAD priming cup and the Syringe dispenser insert if they are left in the priming trough.

RAD Well Map

RAD technology's single-channel dispenser is ideal for partially filling a plate. It lets you pick the individual wells to dispense to (hit-picking). Green wells are dispensed to, white wells are skipped.

Quick Dispense	Protocol Dispense Step
Press Well Map	Create/Edit the Protocol > P-Dispense , enable RAD and select Advanced options , then Well Map

- Select a well to toggle its state: fill or skip.
- Select a column or row header to fill or skip the whole row or column.
- In the top corner of the map, use the **All** options to change the fill or skip state of the wells.



The multiple-well selection options use the state of the first well in the row, column, or plate (A1) to determine whether to fill or skip the remaining wells.

Require a Specific Peri-pump Cassette

When defining a Peri-pump step you can require a specific cassette type. Choose the desired behavior when the required cassette is **not** installed at runtime:

- **Prompt the user to confirm:** provides the best protection against an unintentional mismatch. If the cassette type itself has been physically changed to match the protocol, but the instrument's setting has not been updated, this option changes the MultiFlo FX's setting upon confirmation. However, if the cassette has not been changed to match the protocol, users are given a chance to cancel the run, fix the error, and rerun the protocol.
- **Return an Error code:** gives robotics programmers the ability to design and run unattended processing routines without fear of a message screen interrupting the operation.
- **Automatically Set the cassette type:** this option changes the MultiFlo FX's setting without a confirmation. This option is for advanced users only.

- No action is taken when the cassette type setting matches the protocol's required cassette type.

- RAD technology cassettes add a layer of complexity to this feature. Error code 6029 is displayed when a mismatch of required or installed cassette types occurs. Be as precise as possible when using this feature for best results.

Note: The **Cassette Requirement Mode** is automatically enforced when a 0.5 μL dispense is requested. In this case, make sure a 1 μL cassette is installed.

LHC	Touch screen
<ol style="list-style-type: none"> 1. Select Tools>Instrument Utilities>Peri-pump Dispenser. 2. Select the desired Cassette Requirement Mode behavior: <ul style="list-style-type: none"> ○ PROMPT ○ ERROR ○ SET 	<ol style="list-style-type: none"> 1. From the home screen, select Instrument>Peri-pump. 2. Select the Cassette Requirement Mode option: <ul style="list-style-type: none"> ○ PROMPT ○ ERROR ○ SET

Peri-pump Advanced Settings

Settings for 0.5 μ L Dispense



Do not alter these settings without explicit instructions from BioTek.

Peri-pump offsets are required to ensure precise and repeatable dispense performance when dispensing 0.5 μ L. The default values were determined after thorough testing and should not be changed. This control is provided in anticipation of potential future changes to the 1 μ L cassette tubing. In that case, explicit instructions to alter the offsets will be provided.

Contact [BioTek TAC](#) for assistance if you have questions about dispense performance at 0.5 μ L.

8-to-1 Tube RAD Cassette

Chute height represents the distance between the bottom of the 8 tube tips to the bottom of the chute tip. The default value reflects the chute provided with the bulk-dispensing cassette. Only change this value if you remove or replace the chute.

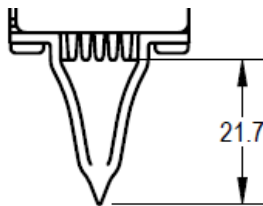

Set the [Chute Height](#) this way:

- If you remove the chute and run the cassette without one, enter 0.
- If you replace the chute, measure from the bottom of the 8 tube tips to the bottom of the replacement chute, and enter that value in millimeters (mm).

Contact BioTek TAC for assistance.

Dual Syringe Dispenser

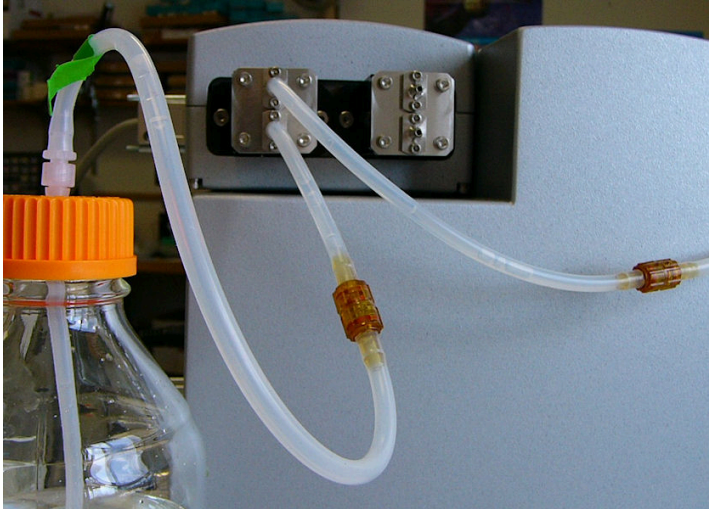

- Some models do not include a Syringe dispenser.

Quick Dispense

In addition to controlling the Syringe dispenser with defined protocol steps, the MultiFlo FX offers a Quick menu to Prime the tubing and Dispense fluid.

How it works

The Syringe dispenser uses two positive-displacement syringe-type pumps and distinct fluid paths to accurately deliver buffer, reagents, and other fluids.

[See Syringe Dispenser- Autoclavable vs. Non-autoclavable on page 167](#) to learn the difference between these two options.

Prime the Tubing

- [How to Prime the Syringe dispenser below](#)
- [Recommended prime volumes for the Syringe dispensers on page 101](#)
- See also: [Syringe Dispenser and Strip Washer Maintenance on page 201](#)

How to Prime the Syringe dispenser

Priming the tubing to remove all air bubbles is critical for accurate dispensing. There are several ways to make sure the tubing is primed:

Quick Prime

1. Select **QUICK** at the home screen.
2. Press **Device** to select Syringe -A or -B or -BOTH.
3. Press **PRIME** as many times as necessary. 5000 μ L is dispensed each time.

Add a Prime step to the Protocol

See [Syringe Prime Step below](#)

Similarly, always include a Pre-dispense (or tip prime) in a Dispense/Wash step.

Keep the tubing wet during idle time

[Turn on AutoPrime for the Syringe Dispenser on page 182.](#)

Syringe Prime Step

Select **S-Prime** and define the parameters to prime the Syringe pump.

Adequate priming is essential for achieving expected performance. It is a good practice to perform this step immediately before a dispense step in the protocol.

The predefined maintenance protocols for the syringe dispensers, e.g. S-DAY_RINSE, fully prime the system, pumping 40 mL through the tubing and pump.



The approximate dead volume for each Syringe dispenser system is 12 mL. Generally, three times the dead volume completely primes the system. When using precious fluids, e.g., expensive reagents, you can change the prime parameters: reduce the volume or number of cycles specified in the predefined protocols or create your own protocols. Use the priming trough inserts to capture expensive reagents when priming.

Define a Prime Step:

1. Select the Syringe to dispense with:
 - **A** or **B** dispenser.
1. Enter the total **Volume** in microliters to flush through the tubing.
2. Define the **Flow Rate**: The rate at which the fluid is dispensed. Options range from 1-5, 1 is the slowest, 5 is the fastest. Lower rates are recommended for viscous fluids.
3. Enter the **Number of prime cycles**.

 To improve performance and possibly preserve reagent, increase the number of cycles and reduce the volume of each cycle. Several small primes often do a better job pushing air from the manifold than one or two large primes.

4. You can **Submerge** the dispense tubes in the fluid **after** the **prime**, if desired. This requires filling the **priming trough inserts**, one for each syringe. Each reservoir holds approximately 6.5 mL.

After the dispense tubes have been primed, the manifold moves down into the priming trough inserts. When both Syringes are enabled, the soak duration begins after both dispensers are primed.

■ **Important:** When using the submerge option, specify a volume that fills the priming trough inserts with sufficient fluid to cover the tubes, e.g. 6000 μ L. And, be sure to use the priming trough inserts when the option is enabled. [Learn more about soaking the dispense tubes...](#)

Set the **Submerge Duration** and fill the **Submerge** checkbox to enable this option.

■ Remove the Peri-pump cassette or its priming trough insert when soaking the Syringe dispenser or washer manifolds.

5. Optionally, adjust the **Pump Delay** when dispensing highly viscous fluids, if necessary to improve performance.

When dispensing highly viscous fluids, the tubing's check valves perform more slowly. Delaying the syringe pump sufficiently to allow the specified amount of fluid to pass through the check valves before being pumped into the syringe has been shown to improve dispense accuracy.

Begin by setting the delay to 500 msec. Experiment with different settings to determine the optimal value for your fluid.

Syringe Dispense Step

S-Dispense

Add a Syringe pump dispense step to the protocol:

LHC/Touch Screen

Click **S-Dispense** and define the parameters

Define the Dispense Step

- Select the **Syringe** to dispense with:
 - A** or **B** or **Both** dispensers.
 - Note: "Both" is not an option when low-density-plate-type manifolds are installed.

■ **Both:** When both Syringe dispensers are used, they simultaneously dispense the specified volume/well in a pattern that varies depending on the plate type. Remember to create **two** prime steps, one for each dispenser, to precede the dispense step. **See [Dispense Pattern with Both Syringes](#) on page 140.**

■ **1536-well Flange Plates:** Use "**Both**" Syringe dispensers when processing 1536F plates.

- Enter the **Volume** to dispense per well. The valid values are 5-30,000 μL depending on the plate type.
- Define the **Flow Rate:** The rate at which the fluid is dispensed. Options range from 1-5, 1 is the slowest, 5 is the fastest. The valid rate is volume dependent. Lower rates are recommended for viscous fluids.

Rates are volume and plate-type dependent:

For example, rate 1 must be used when dispensing between 10-19 μL to a 96-well plate. When dispensing 20-49 μL to a 96-well plate, you can use rates 1 or 2. And, when dispensing 50-59 μL to a 96-well plate, you can use rates 1, 2, or 3. And so on, as shown in these tables.

96-well plate		16-Tube	8-Tube		
μL	Rate	Volume (μL)	Rate	$\mu\text{L}/\text{sec}/\text{well}$	
80-3000	1-5	10-19	1	450	140
60-79	1-4	20-49	1-2	600	209
50-59	1-3	50-59	1-3	750	279
20-49	1-2	60-79	1-4	900	350
10-19	1	80-3000	1-5	1000	420

384-well plate			
μL	Rate	Volume (μL)	$\mu\text{L}/\text{sec}/\text{well}$
40-1500	1-5	5-9	1
30-39	1-4	10-24	1-2
25-29	1-3	25-29	1-3
10-24	1-2	30-39	1-4
5-9	1	40-1500	1-5

- Note: For 16-channel syringes the $\mu\text{L}/\text{sec}/\text{well}$ rate accounts for 2 tubes/well when addressing 96-well plates and one tube/well for 384-well plates.

1536-well plate			
Volume (μL) 3-3000	Rate	SB	LB
The 32-tube manifold flow rates do not have minimum volumes. The $\mu\text{L}/\text{sec}/\text{well}$ for each type of manifold, Small Bore (SB) and Large Bore (LB), is shown:	1	56	125
	2	58	150
	3	60	162
	4	62	174
	5	64	187

The default rate is 3.

Low-density-plate manifolds

Like the standard manifolds described above, for these plate-type-specific manifolds the flow rate is defined as $\mu\text{L}/\text{sec}/\text{well}$ and the minimum volumes are cumulative, i.e. any rate can be used to dispense Rate 5's minimum.

Manifold	Flow/Minimum Volume	Rate 1	Rate 2	Rate 3	Rate 4	Rate 5
6-Well	Flow	560	836	1116	1400	1680
	Min Vol	40	80	200	240	320
12-Well	Flow	420	627	837	1050	1260
	Min Vol	30	60	140	160	220
24-Well	Flow	280	418	558	700	840
	Min Vol	20	40	100	120	160
48-Well	Flow	279	372	560	600	800
	Min Vol	40	80	200	240	320

Enable **Pre-dispense** to normalize the tips before dispensing. Enter the volume and number of cycles.

Select the **Columns** to dispense to (aka the Plate Map):



Each button represents a column.

Use the buttons and **Set** and **Clear** links: The buttons, which represent each column, toggle on and off when selected. Toggle them on to dispense to the column or off to skip the column.

- Each button represents a **column**.
- The number of active column buttons reflects the specified **Plate Type**, which should match the plate you are dispensing to.
- Learn about [Processing Patterns](#) for 384- and 1536-well plates.

Pump Delay

When dispensing highly viscous fluids, the tubing's check valves perform more slowly. Delaying the syringe pump sufficiently to allow the specified amount of fluid to pass through the check valves before being pumped into the syringe has been shown to improve dispense accuracy.

Begin by setting the delay to 500 msec. Experiment with different settings to determine the optimal value for your fluid.

Change the Syringe Dispenser Manifold

Changing the Syringe manifold requires two steps:

- Physically changing the Syringe dispenser manifold: **See [Install the Syringe Dispenser Component on page 62](#)**.
- Updating the instrument's manifold setting; as described below.

After physically changing the manifold, perform these steps to tell the instrument which manifold is installed.

1. LHC: Select **Tools> Instrument Utilities> Syringe Dispenser**
Touch screen: Select **Instrument> Syringe> Manifold**

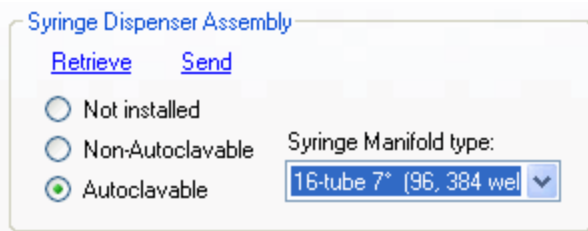

- Choose the option that represents the installed manifold. Look at the top of the manifold to identify its type, which is engraved on the top:

8-tube	Dual 8-tube manifolds in a single block.
16-tube	16-channel.
32-tube	1536-well plates only; Model: Large Bore (LB) or Small Bore (SB).
8-tube	6-well plates only; 4 tubes per well.
9-tube	12-well plates only; 3 tubes per well.
8-tube	24-well plates only; 2 tubes per well.
12-tube	48-well plates only; 2 tubes per well.

- LHC: Click **Send** to send this setting to the instrument.

Syringe Dispenser Settings

Syringe Dispenser Assembly

After installing the Syringe dispenser unit, update the instrument's settings. The MultiFlo FX automatically detects which type of pump is installed. Select the manifold installed.

- **Non-Autoclavable:** the black plastic casing of the non-autoclavable syringes are easy to distinguish from the glass and stainless steel autoclavable syringes.
- **Autoclavable:** glass and stainless steel autoclavable syringes.

8-tube	Dual 8-tube manifolds in a single block.
16-tube	16-channel.
32-tube	1536-well plates only; Model: Large Bore (LB) or Small Bore (SB).
8-tube	6-well plates only; 4 tubes per well.

9-tube	12-well plates only; 3 tubes per well.
8-tube	24-well plates only; 2 tubes per well.
12-tube	48-well plates only; 2 tubes per well.

Look at the top of the manifold to identify its type, which is engraved on the top.

Calibration Data

Calibration data is critical to achieving expected performance and it is unique to each individual syringe unit. BioTek prints the values on the bottom of the unit, so you have a permanent record of the values.

When installing the Syringe dispenser, enter the values printed on the unit.

Syringe Dispenser- Autoclavable vs. Non-autoclavable

Two types of Syringe dispensers are available, autoclavable and non-autoclavable. It is easy to distinguish them:

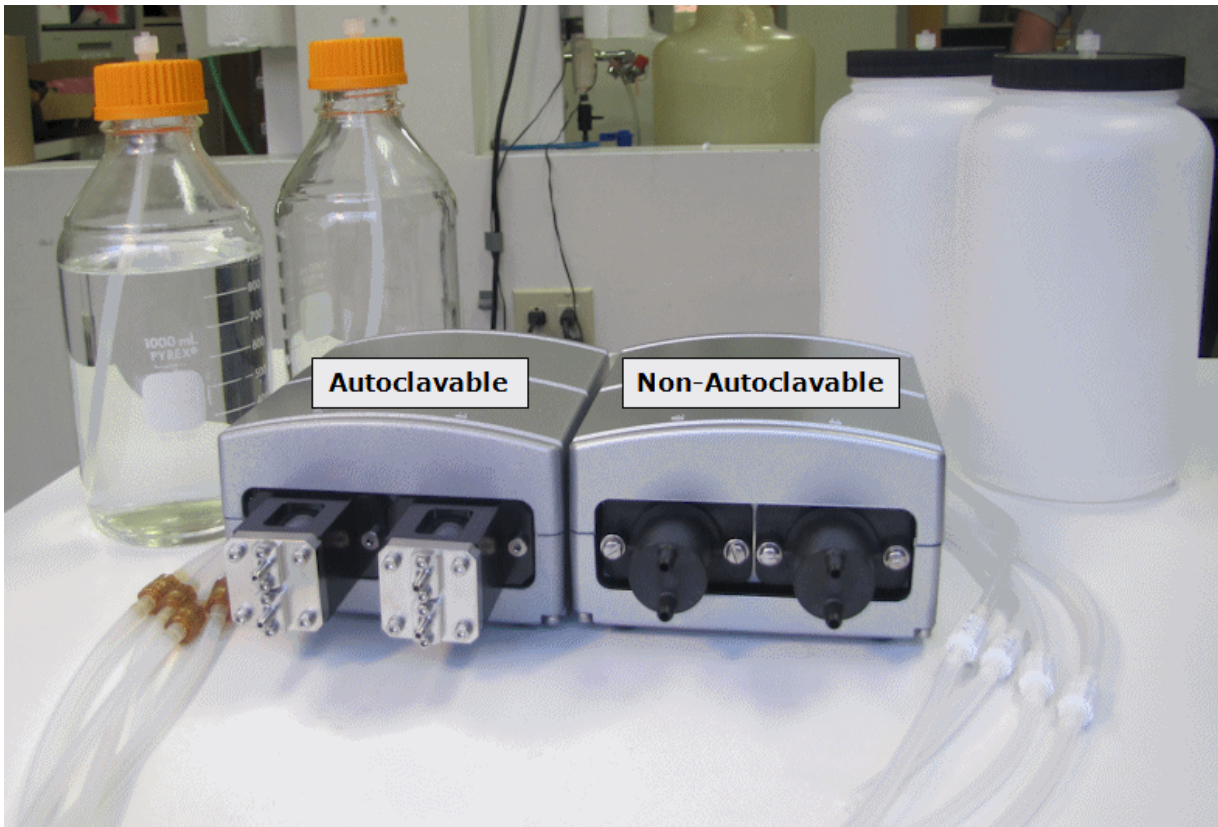

Autoclavable	Non-autoclavable
Stainless steel and glass pump heads	Black plastic pump heads
Glass supply bottles	Plastic supply bottles
Amber, transparent check valves	White, opaque check valves

Changing the Instrument's Settings

About the Onboard Settings

The instrument's onboard settings dictate its behavior. Certain settings, like Plate Clearance, can improve performance. Other settings are critical to its performance. For example, the manifold setting must match the installed manifold type.



LHC users: do not confuse the LHC's [Target Instrument Settings](#) assigned to each protocol with the onboard settings! Review the Help topic: LHC Protocols Explained to learn the distinctions.

To change the onboard settings:

LHC	Touch screen
<ol style="list-style-type: none"> 1. Select Tools>Instrument Utilities 2. Choose the applicable tab and modify settings as desired. 3. Click Send after changing a setting to update the instrument. 	<ol style="list-style-type: none"> 1. Press Instrument>Options for washer settings. 2. Explore the other tabs for more settings.

- When using the LHC to change instrument settings, you may need to reboot the MultiFlo FX **before** controlling it with the touch screen.

Dispense Pattern

Touch screen: Select Instrument>General

Select the fill pattern: by **column** or **row** for processing 384- and 1536-well plates.

For high-density plates, the 8-tip manifold must address the plate multiple times to fill it. Column-wise dispensing fills each column before moving to the next. Row-

wise dispensing fills the first 8 rows, then reverses direction to fill the next 8 rows, and so on. Once it is defined, your pattern preference will apply to all runs, Quick Dispenses and protocols.



Choose **row** for faster throughput or **column** for more precision.

The dispense pattern applies to RAD technology cassettes, as well, but neither option offers an advantage.

Change the Plate Carrier Setting (Touch screen)

The instrument's onboard settings must match the installed hardware.

When you physically change the plate carrier to perform special assays, you must also change the instrument carrier setting to direct the devices to higher or lower positions to accurately address the wells:

1. Select **Instrument > General**.
2. Press the Plate Carrier selection drop-down list to select the currently installed carrier:
 - STD - Standard carrier
 - MTUBE - Mini-tube carrier.

Change the Plate Clearance Setting (Touch screen)

The Plate Clearance setting adds the specified value to the travel height for the selected plate type, i.e. it adds this number to the "Plate Height" value cited in the Plate Types Table. The manifold rises to this height to move from one column to the next and whenever repositioning is needed. This setting does not affect dispense and aspirate heights.

Use this setting to accommodate plates that are slightly taller than standard plates to make sure the manifolds rise high enough above the plate to prevent crashes when the plate carrier moves.

Note: Enabling the **Magnet Adapter Height** affects the travel height, as well as dispense and aspirate heights. The Magnet Adapter Height increases the respective values of all height parameters. Generally, it is best to keep the default setting for Plate Clearance when using the Magnet Adapter Height setting.

To change the setting:

1. Press **Instrument>General**.
2. Touch the number field to enter an offset value in millimeters (mm).

Plate Carrier Speed

For sensitive cell-based assays, especially when using low-density plates with large wells, this setting may improve performance by preventing fluid from sloshing around, potentially disturbing the cell mono-layer or spilling fluid during processing. Setting the speed to **Slow** will apply during both Quick routines and when running protocols.

Upload-Download Protocols (LHC Only)

The LHC lets you transfer protocols from your computer to your instrument and back again.

1. Select **Tools>Transfer Protocols**.
2. Make sure the desired protocols are displayed: check the **Protocol Folder** path for **This computer**. Refresh the list of protocols onboard the **Instrument** by clicking the **Settings** link.
3. Highlight one or more protocols in a display box. (Hold the Ctrl or Shift key to simultaneously select multiple files.)
4. Optionally, at the top left corner of the screen, choose to **Disable Editing** of transferred protocols to lock the protocols from editing or deleting when they are onboard the instrument.
5. Click the applicable **Upload** or **Download** button.

The LHC will confirm the transfer or prompt you for more information. When the transfer is complete, you can manipulate the files as you normally would in their new location.

Transfer Protocols (Touch Screen Only)

You can install protocols on the MultiFlo FX from a USB flash drive and, conversely, upload protocols from the MultiFlo FX to a USB stick. This is useful for sharing protocols with colleagues and obtaining protocols created or modified with BioTek's LHC software.

Prerequisite:

Important: A folder named "Protocols" must be present on the USB flash drive to transfer protocols. Likewise, a folder named "Lid Definitions" is required to transfer these files. Put the protocols you want to download to the instrument in a Protocols folder. Conversely, you can create an empty folder named "Protocols" on the USB stick to upload protocols from the instrument to the USB stick. Do the same to manage Lid Definition files.

To transfer protocols:

1. Insert the memory stick into the USB port on top of the washer.
2. Choose the **File Source: Internal** to copy protocols to the flash drive, or **USB** to copy protocols from it to the MultiFlo FX.
3. Optionally, apply the **Lock files** option to prevent users from changing the protocols.
4. Select files individually by highlighting them (touch) or transfer all protocols simultaneously.

Protocols transferred to the MultiFlo FX can be run from the Home screen and, if not locked, modified from the **Protocol Definition** screen.



Locked files: you can "unlock" a protocol by replacing it using the **Protocol Transfer** control. Upload the protocol to a USB stick, make sure "**Lock files**" is disabled and re-transfer the protocol. It will overwrite the existing file.

Transfer Plate Lid Definitions

For use with BioStack4 plate de-lidder feature: You can install lid definition files on the MultiFlo FX from a USB flash drive and, conversely, upload them to a USB flash drive. This is useful for sharing files with colleagues and obtaining files from BioTek.

Prerequisite:

Important: A folder named "**Lid Definitions**" must be present on the USB flash drive. Put the files you want to download to the instrument in this folder. Conversely, you can create an empty folder named "Lid Definitions" on the USB stick to upload protocols from the instrument to the USB stick.

To transfer Lid Definition files:

1. Insert the memory stick into the USB port on top of the washer.
2. Choose the **File Source: Internal** to copy files to the flash drive, or **USB** to copy files from it to the MultiFlo FX.
3. Optionally, apply the **Lock files** option to prevent users from changing the protocols.
4. Select files individually by highlighting them (touch) or transfer all files simultaneously.

Files transferred to the MultiFlo FX can be attached to a protocol and, if not locked, modified from the **Plate Lid Definition** screen.

Maintenance

Properly maintaining the MultiFlo FX is the key to reliable performance.

Overview	174
Recommended Maintenance Schedule	176
Daily Maintenance	178
Overnight/Multi-Day Maintenance	179
AutoPrime	179
Turn on AutoPrime for the Peri-pump Dispenser	180
Turn on AutoPrime for the Syringe Dispenser	182
Turn on AutoPrime for the Washer	183
Soak the manifold tubes in cleaning fluid	185
Removing Protein Residuals and Fungi Growth	187
Periodic Maintenance	189
Autoclavable Components	190
Clean the Bottles	190
Clean the Plate Carrier	191
Clean the exterior surfaces	191
Peri-pump Dispenser Maintenance	192
Flush the Dispense Cassette	192
Unclog the Dispense Tips	194
RAD Single-tube Cassette - Unclog the Tip	196
RAD 8-to-1 Cassette - Unclog the Tips	197
Record the Number of Plates Processed	199
RAD 8-to-1 Cassette - Replace Chute	200
Syringe Dispenser and Strip Washer Maintenance	201
Clean the Manifolds	201
Clean the Dispense/Aspirate Tubes	202
Clean or Replace the Check Valves	204
Autoclave the Syringe Head	204
Decontamination	205
Tools and Supplies	206
Decontaminate Exterior Surfaces	207
Decontaminate Tubing and Manifold	208
Long Shutdown (Prepare for Storage or Shipment)	208

Storing the Instrument	210
Replace Components	210
Calibrate the Backlash for Syringe Dispenser	212

Overview

A **Preventive Maintenance (PM)** regimen for the MultiFlo FX includes rinsing and soaking the fluid path and cleaning and/or autoclaving the various components. The level of maintenance required to keep the instrument performing as expected is dependent on several factors, including the type of fluid dispensed, the frequency of use, and the work habits employed.

The [Recommended Maintenance Schedule on page 176](#) summarizes BioTek's recommended maintenance tasks, and indicates approximately how often each task should be performed. Daily and periodic routines and minimal guidelines for frequency are listed. Beyond that, it is difficult for BioTek to recommend a fixed frequency for each task to be performed. The frequency of conducting these tasks must be based on the risk and performance factors of your assays.

Develop a maintenance schedule for your MultiFlo FX based on the characteristics of the fluids used and the activity level. Here are some guidelines for each component:

Washer

- If the washer will be idle for several hours or days at a time, soak the tubes to keep them in a "wetted" state. Enable **AutoPrime** if the washer is idle for more than 3 hours.
- Wash solutions affect the rinse frequency. If the solution does **not** contain surfactant, consider rinsing (or running **AutoPrime**) at least once an hour.

Peri-pump

- Purge the fluid at the end of a dispense run and flush the tubing with water (or buffered saline and then water). This is a good practice whenever the dispenser will be idle for more than an hour, and at the end of the day.
- When using the 1 μ L cassette, filter fluids to 50 microns to reduce the chance of the tips clogging.
- When dispensing fluids that can crystallize or harden after use, increase the frequency of maintenance activities. Autoclave the cassette as needed.

- Keep track of the number of plates processed with a cassette to determine when the cassette has reached its expected lifetime and is due for replacement or recalibration.

Syringe Dispenser

- Perform the daily maintenance routines. Flush the dispenser with an appropriate reagent at the beginning of the day (e.g., deionized water in the morning) and at the end of a run.
- When dispensing fluids that can crystallize or harden after use, increase the frequency of maintenance activities. This is especially important for the 32-tube small bore (SB) dispensers.
- Autoclave the Syringe heads and pistons, when applicable, and the 16-tube manifolds as needed. [See Clean the Dispense/Aspirate Tubes on page 202.](#)

Recommended Maintenance Schedule

The schedule recommends preventive maintenance tasks, the frequency with which each task should be performed, and the predefined onboard Maintenance program that should be run (if applicable). [See Recommended Maintenance Schedule on the next page.](#)

■ It is important to note that the risk and performance factors associated with your assays may require that some or all of the procedures be performed more frequently than suggested in this schedule.

■ **Water:** Daily maintenance is the key to keeping the liquid handler performing to specifications. In the maintenance procedures provided in this manual, the requirement to use distilled (dH₂O) or deionized (DI) water can be met by numerous water purification methods, including MilliQ™. A minimum water purity of 2mOhm is expected.

Recommended Maintenance Schedule

Tasks	Frequency				
	Daily	Overnight/ Multi-Day	Weekly	Periodic/ Monthly	Before storage/ shipment
Washer					
Run W-DAY_RINSE	✓	✓			
Run AutoPrime	✓				
Run W-OVERNIGHT_LOOP		✓			
Run W-RINSE_AND_SOAK		✓			
Peri-pump					
Flush dispense cassette	✓	✓			
Record number of plates processed with cassette	✓				
Syringe Dispenser					
Run S-DAY_RIN SE_A&B	✓	✓			
Run AutoPrime	✓				
Components					
Remove protein residuals and fungi growth, (if necessary)	✓		✓	✓	
Check/empty waste bottles	✓				✓
Clean bottles				✓	✓
Clean plate carrier system			✓		✓
Clean washer manifold				✓	✓
Clean aspirate and dispense tubes				✓	✓
Clean exterior surfaces			✓		
Clean Syringe dispenser manifold				✓	✓
Clean Syringe dispenser tubes				✓	✓

Tasks	Frequency				
	Daily	Overnight/ Multi-Day	Weekly	Periodic/ Monthly	Before storage/ shipment
Autoclave Syringe pumps				✓	
Decontaminate					
Decontaminate external surfaces				✓	✓
Run W-DECONTAMINATE				✓	✓
Run S-DECONTAMINATE				✓	✓
Prepare for Storage or Shipment					
Run W-LONG_SHUTDOWN					✓
Run S-LONG_SHUTDOWN					✓
Replace/Repair Components					
Recalibrate Peri-pump cassette	As Needed				
Replace Peri-pump dispense tips/chute	As Needed				
Replace Peri-pump cassette tubing	As Needed				
Replace Syringe dispenser check valves	As Needed				

Daily Maintenance

Daily maintenance involves flushing the washer and dispensers with an appropriate reagent or deionized water throughout the day. Routine rinsing helps to prevent the aspirate and dispense tubes from clogging between runs. Flushing the devices with deionized water is recommended at the end of the day for most applications.

The recommended **rinsing frequency** depends on the solutions currently in use:

- When a solution containing surfactant is used throughout the day, perform the rinsing procedure when the device is idle for more than 3 hours.
- When the solution does **not** contain surfactant, consider rinsing at least once an hour.

■ The type of hardware also affects rinsing frequency. The 32-tube dispense manifolds require more diligence to keep them clog-free.

Run these protocols and enable **AutoPrime** to satisfy the daily maintenance requirements:

- W-DAY_RINSE
- S-DAY_RINSE_A&B
- P-#UL_CASS_RINSE (# represents the cassette type)(P2 protocols are for the secondary Peri-pump)

Make sure the supply bottles contain sufficient rinse solution and that the waste bottles are empty before running the protocols.



Also see the additional maintenance procedures required when dispensing protein solutions: [Removing Protein Residuals and Fungi Growth on page 187](#).

AutoPrime

AutoPrime automatically conditions the dispense tubes, priming them with the specified volume, after a user-specified amount of idle time. **See [AutoPrime on the facing page](#)**.

- Press the **STOP** button to interrupt the AutoPrime routine when it is underway.
- Any interaction with the instrument via the touch screen or the LHC resets the interval clock.

Overnight/Multi-Day Maintenance

Overnight/multi-day maintenance involves flushing all solutions out of the instrument, and then periodically rinsing and soaking the tubes to keep them moist. Here are three recommendations for accomplishing the task. Employ the method that best suits your work flow:

Overnight Loop

To keep the wash manifolds in a wetted condition, you can run these predefined protocols to soak the tubes for several hours at a time:

- **W-OVERNIGHT_LOOP**: requires the washer to remain turned on.
- **W-RINSE_AND_SOAK**: alternatively, run this protocol and turn off the instrument after the soak begins. The tubes will soak in the priming trough until the instrument is turned on again.

AutoPrime

Recommended for optimum performance, AutoPrime keeps the tubing wet in between runs and can be an essential part of your daily maintenance routine.

About AutoPrime

AutoPrime automatically primes the tubing whenever the instrument is idle for a specified time. Keeping the tubes wet prevents clogging and mitigates fluid evaporation at the tips. AutoPrime's submerge feature lets you soak the tubes for extended periods, which is an effective maintenance option.

The downtime interval is defined for all components, but each device supports distinct priming parameters. Devices are primed consecutively, beginning with the syringe dispensers, not concurrently.



Important: Remove the Peri-pump cassette when the Syringe dispenser is set to "Submerge."

"Submerge" is not offered for the Peri-pump because it is not a good practice for the dispense cassettes. However, because the cassette Tip Holder resides on the same dispense arm as the Syringe dispenser manifold, it will be moved into the submerge position when the Syringe tips are submerged. Either remove the cassette altogether when soaking the Syringe tips, or remove the prime trough inserts for

the Peri-pump to prevent cross contamination of fluids or unintended wicking of fluid into the cassette.

- Keep in mind that any interaction with the MultiFlo FX will reset the interval clock. And, AutoPrime only runs when the main menu, quick menu, or run completion message is displayed.

- When AutoPrime is running you can press **STOP** on the keypad to stop it. It will run again the next time the downtime interval occurs.

Specify the Interval and AutoPrime Parameters

AutoPrime runs at the Home screen when the instrument has been idle for a specified interval. One interval setting is defined for all devices.

To set the **AutoPrime Interval**:

LHC:	Touch screen:
<ol style="list-style-type: none"> 1. Select Tools>Instrument Utilities> AutoPrime tab. 2. Specify the idle-time interval that will trigger an AutoPrime; up to 24 hours. 3. Enable and define the parameters for each device. Remember to set a Submerge Duration to employ this option. 4. Click Send to transfer the settings to the instrument. 	<ol style="list-style-type: none"> 1. Select Instrument at the Home screen and select AutoPrime. 2. Specify the idle-time interval that will trigger an AutoPrime; up to 24 hours in minutes. 3. Set the Submerge Duration, if desired. You will select the device to submerge in a subsequent step. 4. At the AutoPrime Device Menu, select the device you want to enable. 5. For each device, define the AutoPrime parameters: rate, volume.

Turn on AutoPrime for the Peri-pump Dispenser

LHC	Touch screen
<ol style="list-style-type: none"> 1. Select Tools>Instrument Utilities>AutoPrime; 	<ol style="list-style-type: none"> 1. Select Instrument >AutoPrime;

LHC	Touch screen
<ol style="list-style-type: none"> 2. Set the AutoPrime Interval: enter the downtime interval that will trigger an AutoPrime. 3. <input checked="" type="checkbox"/> Fill the Enabled checkbox for the dispenser. 4. Set the Volume and Rate. The default settings are 50 μL/tube at the High flow rate. 5. Click Send. Wait for a confirmation message. 	<ol style="list-style-type: none"> 2. Set the AutoPrime Interval: enter the downtime interval that will trigger an AutoPrime (for all devices). 3. <input checked="" type="checkbox"/> Fill the checkbox for the dispenser and, then, press its link. 4. Set the Volume and Rate. The default settings are 400 μL at rate 3.

Details about Peri-pump AutoPrime



Important: Remove the Peri-pump cassette when the Syringe dispenser is set to "Submerge."

"Submerge" is not offered for the Peri-pump because it is not a good practice for the dispense cassettes. However, because the cassette Tip Holder resides on the same dispense arm as the Syringe dispenser manifold, it will be moved into the submerge position when the Syringe tips are submerged. Either remove the cassette altogether when soaking the Syringe tips, or remove the prime trough inserts for the Peri-pump to prevent cross contamination of fluids or unintended wicking of fluid into the cassette.

- Keep in mind that any interaction with the MultiFlo FX will reset the interval clock. And, AutoPrime only runs when the main menu, quick menu, or run completion message is displayed.

- When AutoPrime is running you can press **STOP** on the keypad to stop it. It will run again the next time the downtime interval occurs.

When the Peri-pump AutoPrime is Stopped

Because purging and priming the tubing is the best way to remove air bubbles and prepare the tubing for accurate dispensing, this routine is executed whenever AutoPrime for the Peri-pump is stopped:

1. **Purge:** fluid is purged from the tubing, i.e. returned to the supply vessel. The volume depends on the cassette type (μL /tube).
2. **Prime:** the tubing is primed with the optimal volume of fluid (μL /tube):

Cassette Type	Purge Volume	Prime Volume
10 µL	250	500
5 µL	150	300
1 µL	50	100

Note: these volumes are per tube, except for the RAD cassettes, multiply times 8 for total volume. You may want to disable AutoPrime when trying to preserve expensive reagents.

Turn on AutoPrime for the Syringe Dispenser

LHC	Touch screen
<ol style="list-style-type: none"> 1. Select Tools>Instrument Utilities>AutoPrime; 2. Set the AutoPrime Interval: enter the downtime interval that will trigger an AutoPrime. 3. <input checked="" type="checkbox"/> Fill the Enabled checkbox for the dispenser. 4. Set the Volume and Rate. The default settings are 400 µL at rate 3. 5. Click Send. Wait for a confirmation message. 	<ol style="list-style-type: none"> 1. Select Instrument >AutoPrime; 2. Set the AutoPrime Interval: enter the downtime interval that will trigger an AutoPrime (for all devices). 3. <input checked="" type="checkbox"/> Fill the checkbox for the dispenser and, then, press its link. 4. Set the Volume and Rate. The default settings are 400 µL at rate 3.

Note: The **Volume** dispensed is actually double the input value. The Syringe dispenser always performs two prime cycles during AutoPrime, doubling the volume. For example, when 400 µL is entered, the dispenser actually primes the tubing with 800 µL.

You can **Submerge** the dispense tubes in the fluid **after** the **prime**, if desired. This requires filling the **priming trough inserts**, one for each syringe. Each reservoir holds approximately 6.5 mL.

After the dispense tubes have been primed, the manifold moves down into the priming trough inserts. When both Syringes are enabled, the soak duration begins after both dispensers are primed.

■ **Important:** When using the submerge option, specify a volume that fills the priming trough inserts with sufficient fluid to cover the tubes, e.g. 6000 μL . And, be sure to use the priming trough inserts when the option is enabled. [Learn more about soaking the dispense tubes...](#)

Set the **Submerge Duration** and fill the **Submerge** checkbox to enable this option.

■ Remove the Peri-pump cassette or its priming trough insert when soaking the Syringe dispenser or washer manifolds.

Turn on AutoPrime for the Washer

- Learn about [AutoPrime](#), if you haven't already done so.
1. Select **Tools>Instrument Utilities>AutoPrime** in the LHC or **Instrument>AutoPrime** onboard.
 2. Set the **AutoPrime Interval**: enter the downtime interval that will trigger an AutoPrime.
 3. Fill the checkbox for the washer and press its link.
 4. Set the **Volume** and **Rate**. The default values are 400 μL at rate 3. x2 - Two dispense cycles are performed.
 5. You can **Submerge** the manifold tubes in the fluid **after** the **prime**, if desired. Set **Duration** in **Hours** and **Minutes**.

After the dispense tubes have been primed, the manifold moves down into the priming trough that is filled with the dispensed solution. The tubes are allowed to soak. After the specified duration, the trough is aspirated.

It takes approximately 6.5 mL of fluid to fill the priming trough insert. Be sure to specify a volume of fluid, we recommend **3500 μL** , that will cover the tubes.

■ Note: the washer aspirates fluid during the prime step, but it does not fully evacuate the priming trough insert.

Keep in mind:

- AutoPrime can be stopped when it is underway: press STOP.
- Any interaction with the instrument via the touch screen or the LHC resets the interval clock.
- AutoPrime only runs when the Home screen is displayed.

Submerge and Shutdown

An overnight/multi-day maintenance option for soaking the tips and turning off the instrument for overnight and weekend maintenance.

You can soak the MultiFlo FX dispense manifolds by filling the priming troughs and turning off the instrument after the soak begins. The tubes will soak in the priming troughs until the instrument is turned on again.

1. First, run **S-DAY_RINSE_A&B** but do not empty the priming trough inserts.
2. Turn off the instrument, and lower the manifolds into the priming trough.
3. Run **W-RINSE_AND_SOAK**.
4. When the wash manifold is submerged, turn off the instrument.

If the syringe dispenser manifolds do not lower themselves into their troughs, gently push down on the dispense arm to submerge the manifold tips in the priming fluid.

- Remove either the cassette or the Peri-pump priming trough from the instrument before performing this procedure.

5. Run a [System Self-Test on page 218](#) to empty the washer's priming trough when restarting the instrument.

- Note: the washer aspirates fluid during the prime step, but it does not fully evacuate the priming trough insert.

32-tube Syringe Dispenser

When using the 32-tube dispense manifold, especially the small bore (SB) model, BioTek recommends using the following AutoPrime parameters to keep the manifold clog-free:

Volume: 1000 μ L

Flow rate: 3

Submerge duration: 3 hours (requires priming trough inserts)

Overnight/Multi-day practice: After modifying the AutoPrime parameters to submerge the tubes for several hours:

1. Put the priming-trough-inserts into the priming trough.
2. Use **Quick Dispense** to fill both inserts (prime cups): **QUICK>PRIME** (for both Syringe A and B). Run the **Prime** two or three times to fill the cups.
3. When the priming troughs are filled, press **Main Menu**.

Soak the manifold tubes in cleaning fluid

Keeping the dispense and aspirate tubes in a wetted condition is required to keep them clog free. Soak the tubing in deionized or distilled water or a cleaning fluid whenever the device is not being used to ensure trouble-free performance.

Prime Step

W-Prime

S-Prime

1. Fill a supply bottle with a cleaning agent.
2. Click **W-Prime** or **S-Prime** and define parameters to fully prime the tubing, for example:

Washer	Syringe Dispenser
Volume = 5000 μ L	Volume = 8000 μ L
Flow Rate = 5	Flow Rate = 5
<input checked="" type="checkbox"/> Submerge tips in fluid after prime: enable option and set Duration , up to 24 hours.	

- For the manifolds: Use the priming trough inserts to submerge the tips.

- **Note:** the aspirate manifold does not completely evacuate the priming trough insert.

- **Overnight Maintenance:** You can turn off the instrument after the tips are submerged to leave them soaking in the priming trough for an extended duration.

3. Click **Run**. Save the program with a memorable name for future use.

AutoPrime

Enable **AutoPrime** to ensure the tubing is soaked during downtime intervals.

It is especially important when using the 32-tube SB dispense manifolds to keep the tubes wet to prevent clogs. One option is to modify the AutoPrime parameters used for idle periods during a regular work day to soak the tubing for longer periods overnight and on the weekends.

- Be sure to use the priming trough inserts when the submerge feature is enabled. And, remove either the Peri-pump cassette or its priming trough

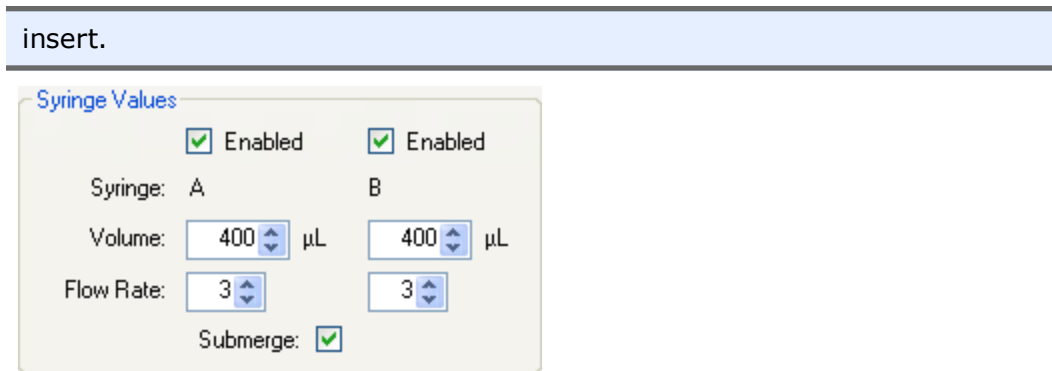

Define the AutoPrime values to fill the priming-trough-inserts, e.g. 6000 µL, and then submerge the tubes for several hours. When AutoPrime is enabled for both dispense manifolds, the soak duration begins after both manifolds are primed, i.e. both priming-trough-inserts have been filled.

More about soaking the dispense tubes...

You can soak the Syringe dispenser's two manifolds, A and B, simultaneously or separately depending on how you define the prime routine. Two priming trough inserts are supplied, one for each manifold. The troughs can be used to preserve precious fluids and to soak the manifold tubes.

- Note: the washer aspirates fluid during the prime step, but it does not fully evacuate the priming trough insert.

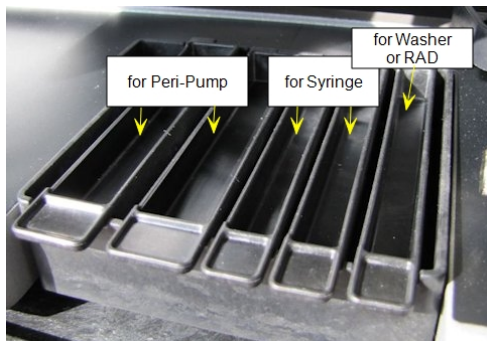

- Be sure to use the **prime trough inserts** to submerge the tips in fluid.

Create a Prime protocol

As an alternative to AutoPrime, BioTek recommends creating a protocol with two prime steps to soak the Syringe dispenser's tubes:

- Do not enable the submerge feature for Syringe A. Specify a volume that fills the prime trough insert, e.g. 6000 µL.

- Create a second prime step for Syringe B, with the same volume, and the submerge duration defined. Both Syringe A and Syringe B dispense tubes will be submerged in their respective prime trough inserts.



Important: Remove the Peri-pump cassette when the Syringe dispenser is set to "Submerge."

"Submerge" is not offered for the Peri-pump because it is not a good practice for the dispense cassettes. However, because the cassette Tip Holder resides on the same dispense arm as the Syringe dispenser manifold, it will be moved into the submerge position when the Syringe tips are submerged. Either remove the cassette altogether when soaking the Syringe tips, or remove the prime trough inserts for the Peri-pump to prevent cross contamination of fluids or unintended wicking of fluid into the cassette.

- Keep in mind that any interaction with the MultiFlo FX will reset the interval clock. And, AutoPrime only runs when the main menu, quick menu, or run completion message is displayed.

- When AutoPrime is running you can press **STOP** on the keypad to stop it. It will run again the next time the downtime interval occurs.

Removing Protein Residuals and Fungi Growth



Important! Solutions containing proteins, such as bovine serum albumin (BSA), will compromise the MultiFlo FX's performance over time unless a strict maintenance regime is adhered to. Do not use isopropyl alcohol or DI water to flush out BSA or similar fluids.

When using protein solutions or similar fluids, BioTek recommends performing the following additional Maintenance procedures to thoroughly flush out protein particles and other contaminants from the fluid path.

Also note, some components can be autoclaved to sterilize them.

Daily Practice with buffer and deionized water:

If the MultiFlo FX will be idle between plates for longer than 45 minutes, flush the proteins using buffer. Use buffer for the AutoPrime, as well, for immediate reuse of the instrument. Otherwise, if the tubes will be allowed to dry, flush the system with DI water to remove the buffer:

1. Fill a supply bottle with buffer solution. Connect the bottle to the washer or dispenser.
2. Run the applicable DAY_RINSE protocol.
3. Enable AutoPrime for 60-minute intervals.

■ Flush the buffer from the system using DI water when the device will be idle for an extended period, i.e. repeat steps 1 and 2 using water.

At the end of the day:

1. Fill a supply bottle with buffer. Connect the bottle to the washer or dispenser.
2. Run the applicable DAY_RINSE protocol three times.
3. Fill a supply bottle with deionized water. And repeat steps 1 and 2.
4. Perform your regular Overnight/Multi-Day Maintenance routine.

Weekly or As Needed use NaOH and HCl to remove proteins:

1. Flush the system with 0.1-0.5 N* NaOH (sodium hydroxide), followed by neutralization with an equivalent normality (0.1-0.5 N) of HCl (hydrochloride).
2. Rinse well with deionized water to remove the HCl.
3. Run the applicable DAY_RINSE protocol three times with deionized water if you plan to use the device immediately.

■ * N = Normal solution, which contains 1 'gram equivalent weight' (gEW) of solute per liter of solution. The gram equivalent weight is equal to the molecular weight expressed as grams divided by the 'valency' of the solute.

Alternatively use an Enzyme-Active Detergent:

1. Mix an enzyme-active detergent according to the manufacturer's directions to fill a four-liter supply bottle. Connect the bottle to the washer's Buffer valve A or one of the Syringes. Connect a bottle of deionized or distilled water to Buffer valve B to rinse the tubing.
2. Run the **W-DECONTAMINATE** or **S-DECONTAMINATE** protocol, as appropriate.
3. Respond to the **Delay** message, "Connect a bottle of water...", leave the detergent bottle connected and when ready, press **Continue**.
4. For the Syringes: connect a bottle with deionized or distilled water to the pump and REPEAT the protocol.
5. When the protocol is completed, connect a bottle containing four liters of deionized water and run W-DAY_RINSE or S-DAY_RINSE three times to flush

the system.

- Repeat the procedure for the other Syringe dispenser.

Periodic Maintenance

Periodic maintenance involves cleaning the components on a regular basis to keep the instrument running efficiently and in compliance with performance specifications. The recommended **frequency for cleaning components** is *at least monthly*. The risk and performance factors associated with your assays may require that some or all of the procedures be performed more frequently.



Warning! Internal Voltage. Turn off and unplug the instrument for all cleaning operations.

■ **Important:** Do not apply lubricants to manifold O-rings, channel-end seals, bottle cover seals, any tubing connection, or any surface that is a part of the fluid path. The use of any lubricant on the fluid handling components will interfere with aspirate and dispense performance, and may cause irreparable damage to these components.

■ **Water:** Daily maintenance is the key to keeping the liquid handler performing to specifications. In the maintenance procedures provided in this manual, the requirement to use distilled (dH₂O) or deionized (DI) water can be met by numerous water purification methods, including MilliQ™. A minimum water purity of 2mOhm is expected.

Important!

- Do not immerse the instrument, spray it with liquid, or use a “wet” cloth on it.
- Do not allow the cleaning solution to run into the interior of the instrument. (If this happens, contact the BioTek TAC.)
- Do not expose any part of the instrument to the recommended diluted sodium hypochlorite solution (bleach) for more than 20 minutes. Prolonged contact may damage the instrument surfaces.
- Be certain to rinse and thoroughly wipe all surfaces.
- Do not soak the keypad. Instead, moisten a clean cloth with deionized or distilled water and wipe the keypad. Dry it immediately with a clean, dry cloth.

Perform these preventive maintenance tasks regularly:

- [Clean the Bottles on the next page](#)
- [Clean the Plate Carrier on page 191](#)

- [Peri-pump Dispenser Maintenance on page 192](#)
- [Syringe Dispenser and Strip Washer Maintenance on page 201](#)

Autoclavable Components

Autoclaving is an efficient method of sterilizing instrument components. For qualified items, it is a good alternative to some of the decontamination procedures.

Do autoclave:	Do NOT autoclave:
Peri-pump cassettes	Washer manifolds
16-Tube and Low-density-plate-type-specific Syringe dispenser manifolds	Plate carrier
Priming trough inserts	32-Tube Syringe dispenser manifolds
Autoclavable Syringe pump head (glass/stainless steel)	8-Tube Syringe dispenser manifolds (gray block holds two manifolds, 16 tubes total)
Syringe module tubing with transparent amber check valves and glass bottles	Non-autoclavable syringe pumps (black plastic)
	Non-autoclavable syringe accessories: white check valves and plastic bottles

- Autoclaving the cassette typically increases the tubes' capacity. Expect the cassette to dispense more fluid than expected immediately after sterilizing or disinfecting the tubing. (When the cassette is completely dry, dispense volumes return to normal.)
- Autoclaving the dispense cassette does not diminish its expected life.

Clean the Bottles

- Clean and rinse the supply bottles with deionized water before the first use, before each refill, and, periodically, as necessary, to prevent bacteria growth.
- Empty the waste bottle often (at least daily), and firmly seat the waste bottle stopper.
- Rinse the covers every time the wash or rinse bottles are filled.
- Accumulated algae, fungi, or mold may require decontamination.

■ To ensure that fluid does not back up into the vacuum pump during operation, always operate the instrument with the **waste sensor cable** installed and the **waste detection sensor** enabled (the sensor is enabled by default).



If fluid collects in the **overflow bottle**, thoroughly rinse the level-switch assembly and bottle.

- Check the hex nuts securing the quick-disconnects to the bottle cap to ensure they are not loose or corroded.

Clean the Plate Carrier

If liquid has overflowed onto the plate carrier, transport rail, or platform glide strips, some buildup may occur and prevent the microplate from seating correctly on the carrier. This can interfere with plate transport. Weekly cleaning is recommended.

1. Turn the instrument off.
2. Lift the carrier up and off the transport rail. Loosen the thumbscrew on the left side of the carrier to release the little bracket that holds the carrier in place and remove the carrier.
3. Clean the carrier, rails, and glide strip surface, using mild detergent and hot water, 70% isopropyl alcohol, or ethanol. Clean the priming trough, too.
4. If detergent was used, wipe the components with a cloth moistened with water. Use a clean, dry cloth to dry the components.
5. Reinstall the carrier:
 - Place it on the transport rail so the slot on its base fits into the **Y-axis Carrier Arm**.
 - Clip the bottom bracket onto the transport rail, align the little bracket on the left rail to hold the carrier in place and tighten the thumbscrew.
 - If necessary, release the spring-loaded microplate clamp in the back left corner of the carrier to level the carrier on the base.

Clean the exterior surfaces

1. Turn off the instrument and disconnect the power cable.
2. Moisten a lint-free disposable towel with water, or with water and mild detergent. **Do not soak the cloth.**
3. If detergent was used, wipe all surfaces with a cloth moistened with water.
4. Use a clean, dry cloth to dry all wet surfaces.

Peri-pump Dispenser Maintenance

The level of the maintenance required to keep the dispenser/washer performing as expected is highly dependent on several factors, including the type of fluid dispensed, the frequency of dispensing, and the work habits employed. For example, when dispensing fluids that can crystallize or harden after use, maintenance activities are required more frequently.



When using the 1 μ L cassette filter fluids to 50 microns to reduce the chance of tips clogging.

Daily maintenance includes purging the fluid at the end of a dispense run and flushing the tubing with water (or buffered saline and then water). This is a good practice whenever the dispenser will be idle for more than an hour, as well as at the end of the day.

Another important daily requirement is keeping track of the number of plates processed with a cassette. This is necessary to determine when the cassette has reached its expected lifetime and is due for replacement or recalibration.

Replacement Tubing Kits, a refurbishment service, and new cassettes are available from BioTek Instruments.

Monthly maintenance requires overall cleaning of the dispenser and its accessories, and verifying performance to determine if the cassette needs recalibration.

Autoclaving or decontaminating the cassette is also recommended.

Peri-pump Maintenance Tasks:

- [Flush the Dispense Cassette below](#)
- [Unclog the Dispense Tips on page 194](#)
- [Record the Number of Plates Processed on page 199](#)
- [RAD 8-to-1 Cassette - Replace Chute on page 200](#)
- [Recalibrate the Peri-pump Dispense Cassette on page 211](#)
- [Replace Peri-pump Dispense Cassette Tubing on page 210](#)

Flush the Dispense Cassette

Prime the tubing with an appropriate reagent at the beginning of the day, and, flush the tubing to effectively remove all contaminants at the end of the day.

The type of rinse fluid to use is determined by the type of fluid you are dispensing. Some dispense fluids require the use of enzyme-active detergent, buffered saline, ethanol or isopropyl alcohol, rather than deionized water alone.

Tools and Supplies

- Deionized or distilled water
- Buffered saline solution or enzyme-active detergent for protein or cell based assays

At the start of the day:

Prime the tubing to prepare for a dispense run.

1. Reload the cassette and fill the supply vessel:
 - When dispensing solutions not effected by water, simply prime with the dispense fluid.
 - When dispensing protein solutions, first prime the tubing with a buffered saline solution to remove any traces of water in the tubing, then, prime with the dispense fluid.
2. **Prime** the tubing until fluid flows into the priming trough and all visible air bubbles have been removed.

At the end of the day:

Purge the tubing to reclaim the dispense fluid, then Prime the tubing to flush it clean.

1. **Purge** the cassette until the tubing appears empty.
2. Replace the supply vessel with the appropriate rinse fluid:
 - When dispensing water soluble solutions use deionized or distilled water.
 - When dispensing protein solutions, first prime the tubing with a buffered saline solution to remove protein particles, then, prime with deionized or distilled water.
3. **Prime** the tubing for the specified duration:
 - 1 μ L cassette = 5 seconds
 - 5 μ L cassette = 7 seconds
 - 10 μ L cassette = 10 seconds.

Unclog the Dispense Tips

The small diameter of the dispense tips makes them susceptible to clogging. You may be able to visually identify a clogged tip, or inaccurate dispense performance may signal a problem. Good work habits can prevent clogging or reduce its occurrence:

- When using 1 μ L cassettes, filter fluids to 50 microns before dispensing.
- Thoroughly flush the tubing after/in-between usage, especially when using liquids that crystallize or harden.

In case the need arises, BioTek ships a 10 cc plastic syringe with special tubing and fitting for use unclogging tips. Installation instructions recommend storing it in the pouch on the back of the instrument. The remedy involves removing the dispense tip and flushing it with water. Depending on the type of clog, soaking the tip holder in hot water with mild detergent is recommended.



This task may be easier if you use the cassette's shipping container to hold the unaffected cassette parts, keeping them out of your way.



Required Materials

- 10 cc syringe with tubing and fitting attachment shipped with dispenser
- Screwdriver shipped with dispenser
- A sufficient quantity of deionized (DI) water in a beaker

Procedure

1. Fill the 10 cc syringe with water and set aside.
2. Remove the cassette from the dispenser.
3. Use the screwdriver to open the **Tip Holder**. Put the top of the holder aside.
4. Lift the affected dispense tube from the holder and pull its tip off the tube.
5. Slide the tip, tapered end first, into the tubing on the end of the syringe.
6. With the tip poised to expel the clog and the water into the beaker or a sink, discharge the syringe.
7. Fill and discharge the syringe as many times as needed to flush the tip.
8. Reassemble the cassette:
 - Push the straight end of the tip into the bottom of the tube (the tapered end of the dispense tip is exposed).
 - Reinsert the tube into the Tip Holder. Seat the flared edges of the tip into the molded slots.
 - Replace the Tip Holder cover with its two screws. The etched BioTek label identifies the top of the cover (except for 1536 cassettes' steel cover plate).

RAD™ Technology Cassettes

Gaining access to the tips is the only difference in the procedure above for unclogging the single-tube and 8-to-1 bulk-dispensing cassettes. Here are some guidelines for disassembling and reassembling the RAD cassettes:

- **See [RAD Single-tube Cassette - Unclog the Tip on the next page](#)**
- **See [RAD 8-to-1 Cassette - Unclog the Tips on page 197](#)**

RAD Single-tube Cassette - Unclog the Tip

Disassemble the cassette to unclog the tip:

Single-tube RAD Cassette

1. Use the screwdriver provided with the MultiFlo FX to disassemble the cassette's tip holder. Remove the two screws on the single-tube cassette's cover to release its bottom plate.
2. Uprturn the cassette's tip holder, and remove the tubing.



3. Pull off the tip and follow the instructions to flush the tip using the 10 cc syringe.
4. When finished, reassemble the tip holder:
 - Put the straight end of the tip into the bottom of the tube leaving the tapered end exposed.
 - 1 μ L tubing: put the little block in the space provided for it.
 - All tubing: slide the flared top of the tip into its molded slot. Only the end of the tip protrudes from the holder.
 - Replace the bottom plate: it only fits one way.
 - Holding the pieces together, turn it over and insert the two screws. Tighten each screw half way, rotating between the two before tightening them all the way.

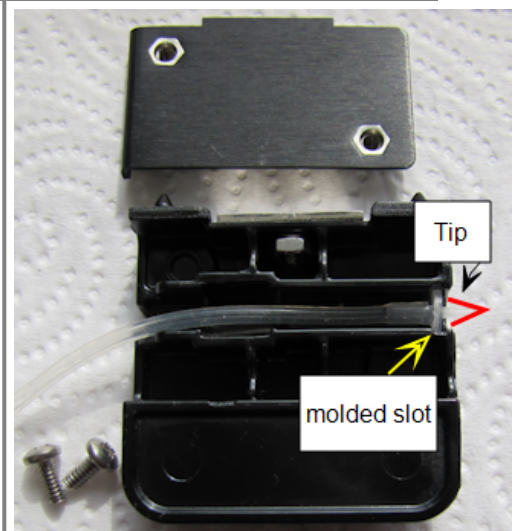

RAD 8-to-1 Cassette - Unclog the Tips

Note: Reassembling the 8-to-1 cassette is somewhat challenging. Before resorting to this method of unclogging the tips, try multiple purge-prime rounds and/or autoclaving the cassette. If that fails, proceed with this method.

Disassemble the cassette to unclog the tips:

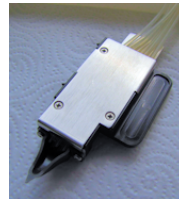

1. Use the Philips screwdriver provided with the MultiFlo FX to remove the three screws on the 8-to-1 cassette's cover plate.
2. Remove the plate and set it aside.
3. Remove the two screws that hold the chute on the cassette.
4. Remove the chute and set it aside. This frees the tips and tubing from the cassette.

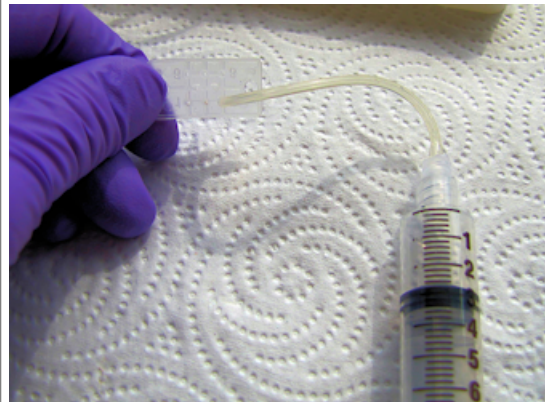
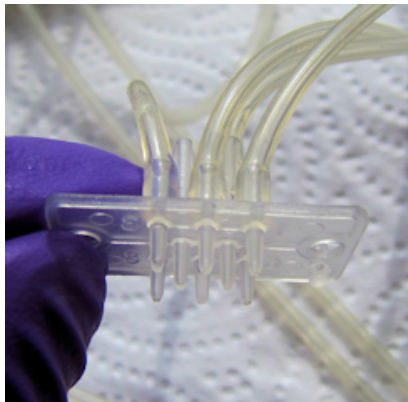
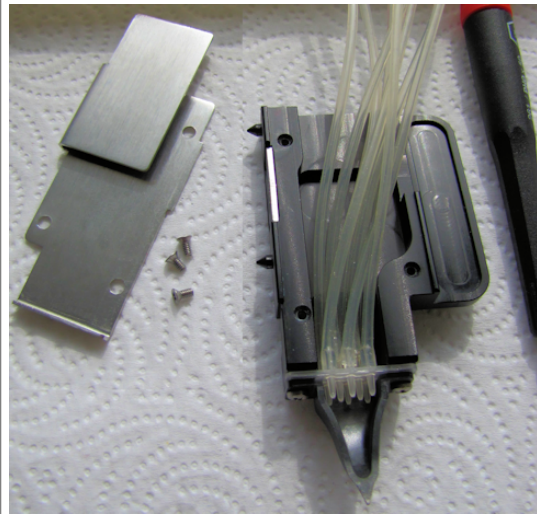

5. Pull the tubing off the tips and follow the instructions to use the 10 cc syringe to unclog tips. [See **Unclog the Dispense Tips** on page 194.](#)
6. When finished, reassemble the cassette:
 - Observe the numbers next to the tubing posts on the back side of the molded tip head. Use the **Center Holder** to determine the proper order for

restoring the tubing: for this procedure the tubes are numbered as shown below, from left to right when facing the center holder.

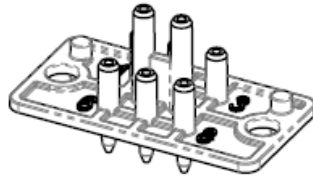
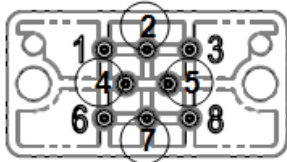
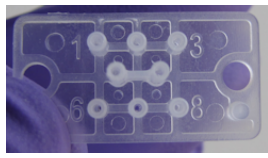

molded tips with tube numbering

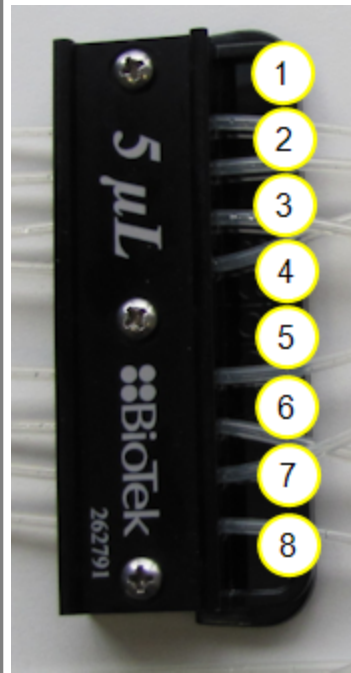

- Push the tubes back onto posts on the molded tip head taking care to place the correctly numbered tube onto its numbered post. Try to make the tubes flush with the tip head.



Use a little isopropyl alcohol on the tubing to help it slide onto the post.

Note: Components fit back together in only one way!



- Attach the tip head (with tubing) to the cassette head by aligning the pins on the tip head with their sockets on the cassette.
- Reattach the chute, aligning it on the same pins and securing it with its two screws. Tighten each screw half way, rotating between the two before tightening them all the way.

- Gather the tubes together, as neatly as possible, and slide them into the groove in the stainless steel cover plate.
- Seat the cover plate correctly on the cassette and secure it in place with its three screws. Tighten each screw half way, rotating between the three before tightening them all the way.



Record the Number of Plates Processed

To determine when a tubing cassette has reached the end of its expected lifetime, make a habit of counting and recording the approximate number of plates and volume dispensed per cassette.

Create a form similar to the example table below or estimate your usage of the cassette and project a date for replacement or recalibration.

Cassette Expected Lifetime

Cassette Types	Cassette Life	Total Volume
1 μ L	1000 384-well plates @ 5 μ L/well	2,000 mL
5 μ L	1000 96-well plates @ 50 μ L/well	5,000 mL
10 μ L	1000 96-well plates @ 100 μ L/well	10,000 mL

With strict adherence to best practices and maintenance recommendations, this is the typical longevity of the dispense cassettes.

Example table for recording cassette usage:

You may want to create a form similar to this table to keep track of the volume dispensed with each cassette:

Cassette serial #: 2178					
Date	# Plates	Plate Type	Volume/Well	Total Daily Vol.	Total Cassette Vol
10/10/08	26	384	5 μ L	49920 μ L	50 mL
10/11/08	33	96	10 μ L	31680 μ L	82 mL

RAD 8-to-1 Cassette - Replace Chute

As needed, you can replace the chute on the 8-tube RAD bulk-dispensing cassette. A spare chute is included in the cassette package.

Use the Philips screwdriver shipped with the MultiFlo FX to remove the chute and replace it with another:

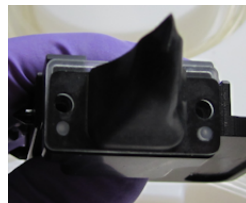
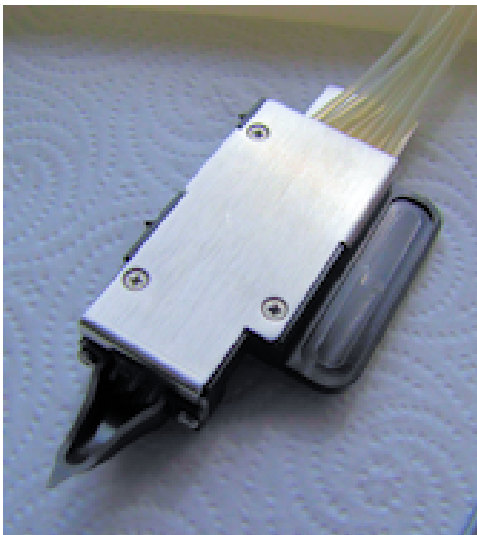

To reattach the chute, align it on the pins on the tip head and secure it with its two screws. Tighten each screw half way, rotating between the two before tightening them all the way.

Syringe Dispenser and Strip Washer Maintenance

The level of the maintenance required to keep the dispenser/washer performing as expected is highly dependent on several factors, including the type of fluid dispensed, the frequency of dispensing, and the work habits employed. For example, when dispensing fluids that can crystallize or harden after use, maintenance activities are required more frequently.

32-tube small bore (SB) dispense manifold: If the fluid streaming from a dispense tube appears to be awry or skewed, it is most likely caused by minute particles of debris on the end of the tube. Brush away any particles from the end of the tube using a piece of silicon tubing. Silicon will not flake off and leave particles behind like other materials.



Clean the Bottles and Tubes

- Clean the dispense and rinse bottles and supply tubes with deionized water before the first use, before each refill, and if they have been idle for any length of time.
- Accumulated algae, fungi, or mold may require decontamination.

Syringe Dispenser Maintenance Tasks

- [Autoclave the Syringe Head on page 204](#)
- [Clean the Dispense Tubes on the next page](#)
- [Clean the Syringe Dispenser Manifold below](#)
- [Clean or Replace the Check Valves on page 204](#)
- Run **AutoPrime** to soak the dispense tubes

Clean the Manifolds

Regular rinsing helps to keep the manifold clean and the dispense tubing clear, and will increase the life of the tubing. Follow the [Decontamination](#) procedure to disinfect the manifold and tubing.

If you suspect a particular problem is related to the manifold (for example, clogged tubes can result in uneven dispensing), you should perform a thorough cleaning of the manifold.

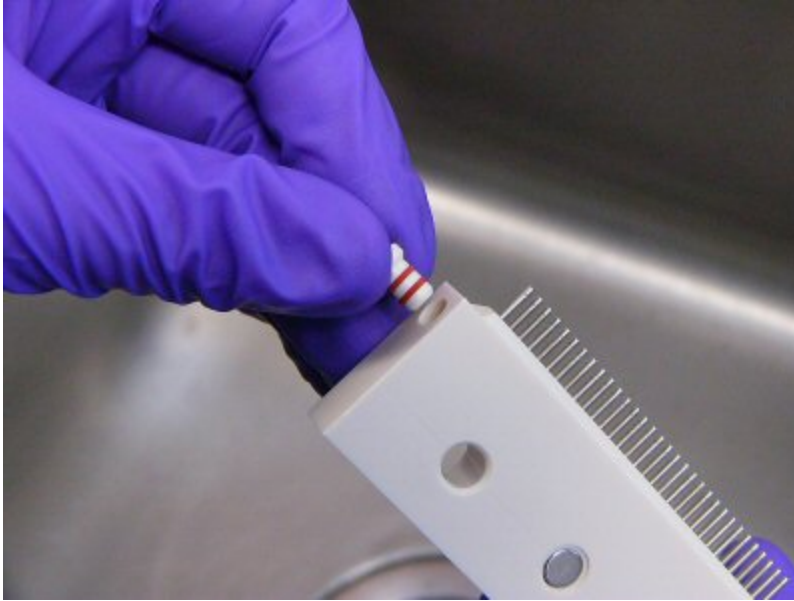

To clean the manifold:

1. Turn off and unplug the instrument.
2. Pull the manifold off of the dispense arm and disconnect the tubing from the manifold.
3. Remove the plugs from the ends of the manifold. Using a lint-free disposable towel, thoroughly clean the outside of the dispense tubes.
4. Run hot water through the inlet fitting. Check to see if water comes out of all of the dispense tubes. If not, soak the manifold in hot soapy water and repeat. [Clean the Dispense Tubes below](#), if necessary.

Clean the Dispense/Aspirate Tubes

■ **Do NOT autoclave the dual 8-tube and 32-tube dispense manifolds!**

■ **Do NOT autoclave the washer dispense or aspirate manifolds!**

■ **Note:** The autoclavable 16-tube and non-autoclavable 8-tube manifolds have removable dispense tubes. We do not recommend routinely removing these tubes. In the case of a particularly difficult problem with any one channel, however, a tube may be removed and cleaned individually, or replaced.

Clean the Tubes

Unless there is a problem, the manifold tubes do not need special cleaning. Periodic rinsing is usually sufficient to keep the tubes clean. However, if the

regular maintenance is not completely successful, try the following:

- washer, 8- and 16-tube manifolds: clean the tubes with the stylus;
- 32-tube manifolds: flush the tubing with the 10 mL syringe.

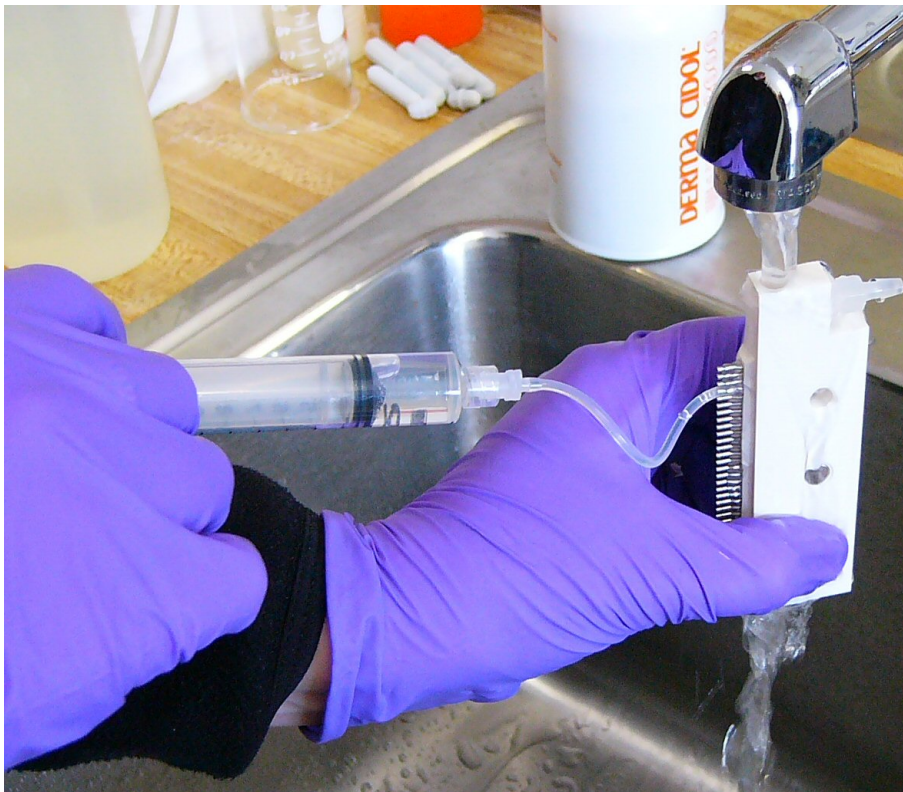

1. Remove the plugs from the ends of the manifold.
2. Tip the manifold on end and flush hot water through this open channel.
3. Using the supplied tool, clean the insides of all of the tubes.
 - washer, 8- and 16-tube manifold stylus: PN 2872304
 - 32-tube manifold: 10 cc syringe and tubing

Let water flow through the open channel while you probe or flush each tube, forcing any particles to be washed away.

4. Rinse the manifold with deionized or distilled water. Check to see if water comes out of all of the dispense tubes (except when working with the 32-tube SB manifold). Reinsert the plugs into the ends of the manifold.
5. Remount the manifold and replace the tubing.
6. Run a Prime protocol using 40 mL of deionized water.
7. Verify dispense performance visually, or [Perform the Syringe Dispense Precision & Accuracy Test on page 236](#).

Clean or Replace the Check Valves

- The check valves do not twist open.

If the check valves leak or become clogged, you can either clean or replace them. Contact BioTek Customer Service to order replacement check valves.

To clean a check valve:

1. Pull the tubing off the check valve.
2. Insert the stylus into the feed end of the valve to hold it open (observe arrow on valve indicating flow direction).
3. Flush with hot water.
4. Replace the valve and the tubing.

[Replace Syringe Dispenser Check Valve on page 211](#), if necessary.

Autoclave the Syringe Head



Certain models of the Syringe dispenser are **not** autoclavable. Be sure your dispenser is described as autoclavable before proceeding. [See Syringe Dispenser-Autoclavable vs. Non-autoclavable on page 167.](#)

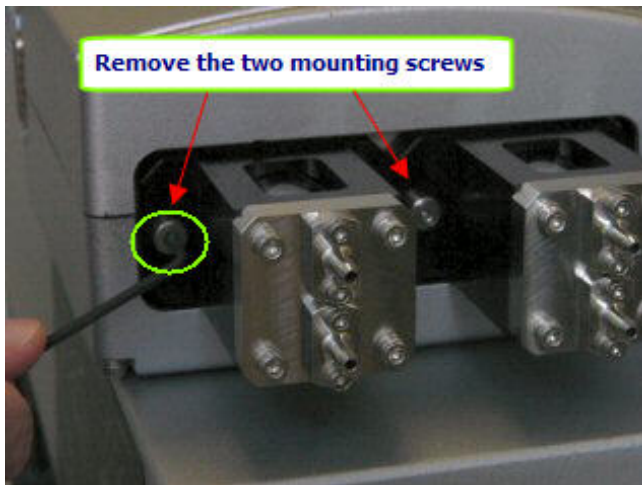

1. Use the supplied 3/32" (2.39 mm) hex wrench to remove the two mounting screws that hold the syringe head in the unit.
2. Pull the syringe head straight back and off of the piston



3. Use the hex wrench to loosen the setscrew on top of the sleeve that holds the piston and then remove the piston.



Important! Autoclave the piston and syringe head separated from one another. Keep the piston and syringe head unattached to each other when autoclaving.

4. Autoclave at 134°C and 216 kPa for 3 minutes, or 121°C and 115 kPa for 30 minutes. The manifold, tubing, autoclavable check valves, and supply bottles may also be sterilized in the autoclave.

- Check valves (PN 68073) recommended for use with organic substances **cannot** be autoclaved.

5. Replace the components by reversing the steps:
6. With the flat side of the shaft facing up, slide the syringe piston shaft into the piston holder until it stops.
7. Use the 3/32" (2.39 mm) hex wrench to tighten the setscrew.
8. Push the syringe head over the piston until it is flush with the unit and use the hex wrench to attach the two mounting screws.

Decontamination

Any laboratory instrument that has been used for research or clinical analysis is considered a biohazard and requires decontamination prior to handling.

Decontamination minimizes the risk to all who come into contact with the instrument during shipping, handling, and servicing. Decontamination is required by the U.S. Department of Transportation regulations. Persons performing the decontamination process must be familiar with the basic setup and operation of the instrument.

The recommended **frequency for decontamination** is at least monthly, and before shipment of the instrument to BioTek for calibration or repair.

- **Important!** BioTek Instruments, Inc. recommends the use of the following decontamination solutions and methods based on our knowledge of the instrument and recommendations of the Centers for Disease Control and Prevention (CDC). Neither BioTek nor the CDC assumes any liability for the adequacy of these solutions and methods. Each laboratory must ensure that decontamination procedures are adequate for the biohazards they handle.



Warning! Internal Voltage. Turn off and unplug the instrument for all decontamination operations.

- **Do not** immerse the instrument, spray it with liquid, or use a “wet” cloth. Do not allow the cleaning solution to run into the interior of the instrument. If this happens, contact the BioTek TAC. **Do not soak the keypad.**

- **Wear prophylactic gloves** when handling contaminated instruments. Gloved hands should be considered contaminated at all times; keep gloved hands away from eyes, mouth, nose, and ears. Eating and drinking while decontaminating instruments is not advised.

- Mucous membranes are considered prime entry routes for infectious agents. Wear eye protection and a surgical mask when there is a possibility of aerosol contamination. Intact skin is generally considered an effective barrier against infectious organisms; however, small abrasions and cuts may not always be visible. Wear protective gloves when performing the decontamination procedure.

Tools and Supplies

0.5% sodium hypochlorite (NaClO, or bleach)
70% isopropyl alcohol (as a bleach alternative)
Deionized or distilled water
Priming plate
Safety glasses
Surgical mask
Protective gloves

Lab coat
Biohazard trash bags
Clean cotton cloths

Step-by-Step Decontamination Instructions:

- [Decontaminate Exterior Surfaces below](#)
- [Decontaminate Tubing and Manifold on the next page](#)
- [Alternate Decontamination Procedure for Tubing and Manifold on page 1](#)

Decontaminate Exterior Surfaces



Caution! Be sure to check the percentage NaClO of the bleach you are using; this information is printed on the side of the bottle. Commercial bleach is typically 10% NaClO; in this case, prepare a 1:20 dilution. Household bleach is typically 5% NaClO; in this case, prepare a 1:10 dilution.



The bleach solution is caustic; wear gloves and eye protection when handling.

1. Turn off the instrument and disconnect the power cord. Empty the waste bottle.
2. Unload the Peri-pump cassette and the prime trough inserts, and remove the Syringe dispenser manifold and tubing, if applicable.
3. Autoclave the cassette and other autoclavable components.
4. Prepare an aqueous solution of 0.5% sodium hypochlorite (NaClO, or bleach). As an alternative, 70% isopropyl alcohol (or 70% ethanol) may be used if the effects of bleach are a concern.

■ **Isopropyl alcohol** is not recommended for removing **proteins** (such as bovine serum albumin).

5. Moisten a cloth with the bleach solution or alcohol. **Do not soak the cloth.**
 - Wipe the touch screen (do not soak). Wipe again with a clean cloth moistened with deionized or distilled water. Dry immediately with a clean, dry cloth.
 - Wipe the plate carrier, top surface of the instrument's base, supply bottles and tubing, and all exposed surfaces of the instrument.
6. Wait 20 minutes. Moisten a cloth with DI or distilled water.

- Wipe the inside and outside surfaces of the Peri-pump cover panel.
 - Wipe the plate carrier, top surface of the instrument's base, supply bottles, tubing, bottle covers and all exposed surfaces of the instrument that have been cleaned with the bleach solution or alcohol.
7. Use a clean, dry cloth to dry all wet surfaces.
 8. Reassemble the instrument as necessary.
 9. Discard the used gloves and cloths using a biohazard trash bag and an approved biohazard container.

Decontaminate Tubing and Manifold

Predefined protocols to flush and soak the supply tubing and manifolds with disinfectant, then flush the system with rinse fluid, are installed onboard the instrument and on the host computer during installation of the LHC:

- **W-DECONTAMINATE** for the washer
- **S-DECONTAMINATE** for the Syringe dispenser (two protocols: for dispenser A and dispenser B)

When storing or shipping the instrument, the **LONG_SHUTDOWN** procedure ([page 208](#)) primes and soaks the instrument, and ends by pushing air through the system. The parameters can be edited for optimum cleaning. For example, consider using ethanol instead of air to complete the decontamination process.

- Two supply bottles are required for this procedure: one for disinfectant, and one for rinse.

1. Empty the waste bottle, if necessary.
2. Prepare an aqueous solution of 0.5% sodium hypochlorite (NaClO, or bleach).
3. Fill one supply bottle with at least 400 mL of bleach solution (disinfectant).
4. Fill another supply bottle with at least 800 mL of deionized water (rinse).
5. Reconnect the power cord and turn on the instrument.
6. Run the decontamination protocols.

Long Shutdown (Prepare for Storage or Shipment)

Before the MultiFlo FX is shipped or stored, the entire system should be rinsed and soaked with disinfectant and then purged of all fluid. Perform these steps when leaving the instrument unused for a long period of time.

Predefined protocols are installed onboard the instrument and on the host computer during installation of the LHC:

- **W-LONG_SHUTDOWN** — for the washer
- **S-LONG_SHUTDOWN** — for the Syringe dispenser

The LONG_SHUTDOWN protocols flushes and soaks the supply and manifold tubing with disinfectant, then flushes with rinse, and finally purges the system of fluid.

 For the Syringe dispensers: copy this protocol and modify it to run on Syringe B.

- Three supply bottles are required for this procedure: one for disinfectant, one for rinse, and one for air.



Caution! Be sure to check the percentage NaClO of the bleach you are using; this information is printed on the side of the bottle. Commercial bleach is typically 10% NaClO; in this case, prepare a 1:20 dilution. Household bleach is typically 5% NaClO; in this case, prepare a 1:10 dilution.

1. Turn the instrument off and disconnect the power cord.
2. Unload the Peri-pump cassette and the prime trough inserts, if applicable. Clean and store them separately.
3. Empty the waste bottle.
4. Prepare an aqueous solution of 0.5% sodium hypochlorite (NaClO, or bleach).
5. Fill one supply bottle with at least 400 mL of bleach solution (disinfectant).
6. Fill another supply bottle with at least 800 mL of deionized water (rinse).
7. Keep the third supply bottle empty (air).
8. Turn on the instrument and run **W-LONG_SHUTDOWN**.

- While this program is running, you will need to periodically check the display panel and follow the instructions.

9. When the washer has been cleaned and purged, repeat the process to clean and purge the Syringe dispensers, if applicable:
 - Prepare the supply bottles with disinfectant, rinse and air;
 - Run **S-LONG_SHUTDOWN**

Storing the Instrument

After performing the [Long Shutdown \(Prep for Storage or Shipment\) on page 208](#) protocols:

- Turn off the instrument and disconnect the power cord.
- Store it on a flat surface that is relatively free of vibration, in a dust-free and particle-free environment.
- Protect the instrument from temperature extremes that can cause condensation within the unit and from corrosive fumes and vapors.
- Store the instrument under the following environmental conditions:

Temperature:	20° to 50°C (-4° to 122°F)
Relative humidity:	10% to 85% (non-condensing)

- Important: Allow the instrument to reach room temperature before use after storage.

Replace Components

Some components of the MultiFlo FX must be replaced periodically to maintain specified performance levels.

Peri-pump Components

- [Replace Peri-pump Dispense Cassette Tubing below](#)
- [Recalibrate the Peri-pump Dispense Cassette on the facing page](#)

Syringe Dispenser and Strip Washer Components

- [Clean or Replace the Check Valves on page 204](#)
- [Calibrate the Backlash for Syringe Dispenser on page 212](#)

Replace Peri-pump Dispense Cassette Tubing

BioTek provides replacement tubing kits as an alternative to buying a new cassette. Purchase the replacement tubing kits from BioTek and follow the instructions shipped with the kit or on the MultiFlo FX Operator's Manual CD/USB stick in the "Cassette Calibration" folder, titled: **7171017_(current Rev)_Replacing the tubing_8x14.PDF**. For the best experience with these instructions print them on legal size paper (8½" x 14").

Recalibrate the Peri-pump Dispense Cassette

Gravimetric Method

The most precise method for calibrating a cassette is the gravimetric method. Find the instructions and an Excel[®] spreadsheet on the MultiFlo FX Operator's Manual USB stick, titled: **Gravimetric Calibration Instructions 7171024 (current Rev).pdf**.

Calibration Jig

BioTek offers an accessory for recalibrating dispense cassettes. The Calibration Kit (PN 7170017) includes an 8-pipette jig, instructions and an Excel spreadsheet that may save time when calibrating a cassette.

Follow the instructions shipped with the kit or find them on the MultiFlo FX Operator's Manual USB stick, titled: **Calibration Jig Instructions 7171009 (current Rev).pdf**.

Important: After calibrating the cassette, BioTek recommends performing the "Peri-Pump Dispense Precision and Accuracy Tests" defined in the operator's manual and IQOQPQ procedure to verify the cassette meets specifications.

Replace Syringe Dispenser Check Valve

You can order replacement check valves from BioTek Customer Care if your check valves become clogged and cleaning them does not solve the problem:

- PN 68083 — Autoclavable valves for use with non-organic substances.
- PN 68073 — Check valves recommended for use with organic substances.

■ If you observe a decline in performance after changing the check valves, [Calibrate the Backlash for Syringe Dispenser on the next page](#).

Calibrate the Backlash for Syringe Dispenser

■ **Plate-Type-Specific Syringe Manifolds:** this procedure requires an experienced user and both standard 8- and 16-channel manifolds to determine the backlash for these special manifolds. Contact BioTek TAC for assistance.

If you have replaced a check valve and subsequently noticed a decline in performance, recalibrating the backlash is recommended to restore accuracy in dispense volumes.

Equipment Required

- Microplates: 384-well plates for testing the 16-tube dispensers (which can be replaced with 96-well plates if more applicable for your lab); 1536-well plates for testing the 32-tube dispensers; and 96-well plates for testing the 8-tube dispensers.
- Precision balance with minimum capacity of 100 g and readability of 0.001 g resolution
- Supply bottle with deionized water

Setup

While calibrating and testing, try to maintain a steady liquid level in the supply bottle, keeping it half full. Start with more fluid to allow for priming. Connect the supply bottle to the Syringe under test. Make sure the supply bottle is at the same level as the dispenser.

Create a Dispense Protocol

Create a protocol that dispenses the correct volume for the manifold under test:

- 16-tube manifold: **20 µL** per well to a **384-well** plate at Flow Rate **2**.
- 32-tube manifold: **6 µL** per well to a **1536-well** plate at Flow Rate **2**.
- 8-tube manifold: **20 µL** per well to a **96-well** plate at Flow Rate **2**.

Prime and Dispense

1. Run a Prime protocol, for example, **S-DAY_RINSE** or **S-DAY_RINSE_A&B** when both Syringe pumps need calibration, to remove air bubbles from the tubing.
2. Place the plate on the balance, and tare the balance.
3. Place the plate onto the carrier and run the dispense protocol created above.

4. Upon completion, carefully remove and reweigh the plate to determine the **Actual Weight**.
5. The **Expected Weight** is:
 - 16 tube = 7.680 grams
 - 32 tube = 9.216 grams
 - 8 tube = 1.920 grams
6. Calculate the volume (weight) error and the backlash adjustment that needs to be made:
 - 16 tube: $(7.680 - \text{Actual Weight} \div 24 \div [.0033 \text{ or } .0031*]) = \text{backlash setting}$
 - 32 tube: $(9.216 - \text{Actual Weight} \div 48 \div [.0033 \text{ or } .0031*]) = \text{backlash setting}$
 - 8 tube: $(1.920 - \text{Actual Weight} \div 12 \div [.0033 \text{ or } .0031*]) = \text{backlash setting}$
 - * use .0033 for autoclavable units; use .0031 for non-autoclavable units.
 - Subtract the Actual Weight from the Expected Weight and divide by the number of columns dispensed to.
 - Divide the result by 0.0033 and round to the nearest whole number.

Example: $7.680 - 7.550 = 0.130$, $0.130/24 = 0.00542$, $0.00542/0.0033 = 1.64$ rounded to 2. The backlash setting needs to be adjusted by 2.

7. Adjust the backlash as necessary: select **Tools>Instrument Utilities> Syringe Dispenser** and enter the number of steps in the applicable **Backlash** fields in the **Calibration Data** group box.
8. Repeat steps 1 through 4 until the volume dispensed is within one backlash unit of being exact: **± 0.119 mL**.

Qualification

This chapter provides instructions for periodically testing the instrument to verify that it meets performance specifications.

Qualification Overview	216
Qualification Schedule	217
System Self-Test, Verify Information	218
Liquid Testing the MultiFlo™ FX Multi-Mode Dispenser	219
Peri-pump Dispense Precision and Accuracy Tests	221
Perform the Peri-Pump Precision and Accuracy Tests	224
Syringe Dispenser Liquid Tests	235
Perform the Syringe Dispense Precision & Accuracy Test	236
Washer Qualification Liquid Tests	250

Qualification Overview

Instrument verification for the MultiFlo FX involves three activities: qualification of installation and setup, qualification of routine capability, and qualification of long-term stability. These activities are called Installation Qualification (**IQ**), Operational Qualification (**OQ**), and Performance Qualification (**PQ**), respectively. Verification testing includes:

- The **System Self Test** verifies system components, such as the vacuum, manifold, and carrier positioning. The **Checksum Test** verifies the basecode software against internal checksum values to ensure that no corruption has occurred.

Washer

- **Evacuation Efficiency:** This test measures the residual volume per well after aspiration. The lower the residuals per well, the better the evacuation efficiency of the washer.
- **Dispense Precision:** This test measures the variability of volumes dispensed from tube to tube across the manifold.

Washer Qualification Tests:

- [Dispense Precision and Accuracy Test on page 253](#)
- [Evacuation Efficiency Test on page 254](#)

Peri-pump and Syringe Dispensers

- **Dispense Precision** is a measure of the variability of volumes dispensed from tube to tube across the manifold or tip holder. The optical density of the solution in a well is proportional to the total volume of the solution in the well. When the % Coefficient of Variation (%CV) is calculated, the result is a measure of the uniformity of the distribution of dispensed volumes across the manifold. It is the ratio, expressed in percent, of the standard deviation of the distribution of fluid volumes in the wells to the mean value of volume per well. The uniformity of distribution across the manifold improves as the %CV is lowered.
- **Dispense Accuracy** is a measure of the average volume dispensed per well. It is independent of precision. The volume per well may vary greatly over a plate, yet the accuracy may be exact because it is an average of the volumes.

Peri-pump Qualification Tests:

- [Performing the Peri-Pump Precision and Accuracy Tests on page 224](#)

Syringe Dispenser Qualification Tests:

- [Perform the Syringe Dispense Precision & Accuracy Test on page 236](#)

Qualification Schedule

The following schedule defines the factory-recommended intervals for verification tests for an instrument used two to five days a week. The schedule assumes that the MultiFlo FX is properly maintained as outlined in the [Recommended Maintenance Schedule on page 176](#).

■ **Note:** An instrument qualification package (PN 1260521) is available for purchase. The package contains thorough procedures for performing Installation Qualification, Operational Qualification and Performance Qualification (IQ-OQ-PQ) and preventative maintenance (PM). Extensive Checklists and Logbooks are included for recording results. Contact your local dealer for more information.

Tests	IQ	OQ	PQ
	Initially	Annually	Monthly
Unpacking, Installation, and Setup	✓		
System Self Test and Checksum Test	✓	✓	✓
Shake Test		✓	
Washer Evacuation Efficiency Test		✓	✓
Washer Dispense Precision & Accuracy Test		✓	✓
Peri-pump Dispense Precision and Accuracy Test		✓	✓
Syringe Dispense Precision and Accuracy Test		✓	✓
Run Assay			✓

■ **Important!** The risk factors associated with your assays may require that the Operational and Performance Qualification procedures be performed more or less frequently than shown above.

System Self-Test, Verify Information

Perform these steps to verify software information and run a system self-check:

Prerequisite: When controlling the instrument with the LHC, ensure that it is attached to the host computer and turned on, and then launch the LHC software.

To run the System Self-Test:

LHC	Touch screen
Select Tools>Instrument Utilities>General Settings . Under Instrument Functions , click Perform Self-check .	<ol style="list-style-type: none"> 1. Select Instrument at the Home screen. 2. On the Other screen, press Run Self-Check.

Test Results:

- If the test fails, an error code displays. If this happens, find the error code in the MultiFlo FX Operator's Manual to determine its cause. If the problem is something you can fix, turn off the instrument, fix the problem, and then turn the instrument back on and re-run the test. If the problem is not something you can fix, contact BioTek's Technical Assistance Center.

Record Onboard Software

Record the software part number and version installed on the MultiFlo FX.

LHC	Touch screen
<ol style="list-style-type: none"> 1. Select Tools>Instrument Utilities 2. Select the Software tab and from the Basecode Software Information section record the <ul style="list-style-type: none"> • Software Version and part number 	<ol style="list-style-type: none"> 1. Select Instrument at the Home screen. 2. Record the Software part number and version from the About screen.

Liquid Testing the MultiFlo™ FX Multi-Mode Dispenser

Which Tests to Perform?

We recommend that you perform these routine tests before first use (after the IQ) and then monthly:

Washer

- **Dispense Precision and Accuracy Test.** Precision tests measure the variability of volumes dispensed from tube to tube across the manifold and Accuracy tests measure the average volume dispensed per well.
- **Evacuation Efficiency Test.** Measures the residual volume per well after the aspiration aspect of plate washing. The lower the residuals per well, the better the evacuation efficiency of the washer.

Perform the tests applicable to the installed wash manifold type.

Peri-pump Dispenser

- **Dispense Precision and Accuracy Test.** For each Peri-pump installed perform two tests, one at the volume that matches the cassette type and another that best represents the cassette type and dispense volume most common to your applications.
- **RAD Technology Cassettes:** For the single-tube cassettes, perform the two tests as recommended for the standard cassettes, except limit the dispense to only one row. For the 8-to-1 bulk-dispensing cassette, perform the special test procedure.

Syringe Dispenser

- **Dispense Precision and Accuracy Test.** Perform two tests for each syringe using the tests that best represent the plate type and dispense volume most common to your applications.

Standard manifolds:	Liquid Tests
8-tube manifolds (1 unit)	Test 1 and Test 2
16-tube manifolds	Test 1 and Test 2
32-tube manifolds	Test 3
Low-Density-Plate-Type-Specific Manifolds:	
6-, 12-, 24-, 48-well manifold	Plate-type-specific test

Important Recommendations for All Liquid Tests

Test Solutions

- Using pure deionized water in place of the test solutions is *not* recommended and will likely result in the failure to meet specifications.
- Prepare the solutions the day before you plan to run the tests. This will allow any foam caused by the agitation of solutions containing Tween[®] 20 to settle.
- BioTek determined the pass/fail specifications for the instrument tests using the recommended test solutions. You may use your own buffer solution instead, but if any tests fail using your own buffer, retry the tests using the recommended solutions.

Plate Reading

- If you are using one of BioTek's keypad-based readers, such as the ELx800 or ELx808, ensure that the reader is **not** running in **Rapid mode**. To check the setting, select **UTIL → READ** and cycle through the options until READ IN RAPID MODE? appears. Set it to **NO**.
- The absorbance of blue dye solutions should be measured at 630/450 (or 405) nm. The BioTek blue dye solution part number is **7773001**.
- The final absorbance for all dye solution concentrations should be in a range between 0.700 and 1.600 OD.

Recording Test Results

- Use the Liquid Test Worksheets at the end of this section for recording data reduction results. If your tests are failing, this information will be useful for BioTek TAC to help diagnose any problems.

Peri-pump Dispense Precision and Accuracy Tests

Dispense Precision and Accuracy Specifications

Cassette	Precision	Accuracy
1 μ L	10%CV @ 1 μ L per well	\pm 10% @ 1 μ L per well
	5%CV @ 2 μ L per well*	\pm 5% @ 2 μ L per well*
	10%CV @ 0.5 μ L per well	n/a
5 μ L	5%CV @ 5 μ L per well	\pm 4% @ 5 μ L per well
	2.5%CV @ 10 μ L per well*	\pm 2% @ 10 μ L per well*
10 μ L	4%CV @ 10 μ L per well	\pm 4% @ 10 μ L per well
	2%CV @ 20 μ L per well*	\pm 2% @ 20 μ L per well*
* These specifications are for these dispense volumes and higher.		

Exception: the accuracy specs above apply to the RAD technology bulk-dispensing cassette, 8 tubes-to-1 (chute) with 5 μ L tubing for volumes that are 8 times the full unit increments for the cassette, e.g. valid at 40, 80, 160, ... 30,000 μ L:

- \pm 4% when volume is 40 μ L/well
- \pm 2% when volume is \geq 80 μ L/well.

■ **Note:** For IQ/OQ/PQ purposes you can add 1.0% additional tolerance to the Precision %CV to accommodate various test solutions, off-peak wavelengths, reader errors, and pipette errors.

Peri-pump Precision and Accuracy Testing Methodology

Tare an empty plate on a balance. Use the Peri-pump to dispense a quantity of fluid with a known dye concentration to the wells. Weigh the plate to obtain the weight of the fluid dispensed. Pipette deionized water on top of the dye to bring the wells up to a more optically measurable volume (if necessary). Read the wells in a microplate reader and determine the percentage Coefficient of Variance (%CV) among all wells, and gravimetrically determine the accuracy of the volume dispensed in each well (% Accuracy Error).

BioTek recommends performing two tests, one at the volume that matches the cassette type and another that best represents the cassette type and dispense volume most common to your applications:

Tests – Solutions	Cassette Types			
	1 μ L	1 μ L 1536	5 μ L	10 μ L
1 μ L	✓	✓		
5 μ L			✓	
10 μ L	✓			✓
50 μ L			✓	
100 μ L				✓
1536		✓		
8-to-1			✓	

- **1 μ L Test:** Confirms the performance of the 1 μ L cassettes when dispensing a single aliquot (1/4 turn of pump) into each well of the plate. It dispenses 1 μ L into each well using the **1 μ L Solution**, and requires an additional 150 μ L of deionized or distilled water to raise the fluid level for optimal reading.

■ A single aliquot for a cassette type is the smallest volume unit recommended for it. 1 μ L for the 1 μ L cassette, 5 μ L for the 5 μ L cassette, and 10 μ L for the 10 μ L cassette (except that later model instruments can dispense 0.5 μ L/well using a 1 μ L cassette).

- **5 μ L Test:** Confirms the performance of the 5 μ L cassettes when dispensing a single aliquot (1/4 turn of pump) into each well of the plate. It dispenses 5 μ L into each well using the **5 μ L Solution**, and requires an additional 150 μ L of deionized or distilled water to raise the fluid level for optimal reading.
- **10 μ L Test:** Confirms the performance of the 1 μ L cassettes when dispensing 10 aliquots (2 1/2 turns of pump) and the 10 μ L cassettes when dispensing a single aliquot (1/4 turn of the pump) into each well of the plate. It dispenses 10 μ L into each well using the **10 μ L Solution**, and requires an additional 100 μ L of deionized or distilled water to raise the fluid level for optimal reading.
- **50 μ L Test:** Confirms the performance of the 5 μ L cassettes when dispensing 10 aliquots (2 1/2 turns of pump) into each well of the plate. It dispenses 50 μ L into each well using the **50 μ L solution**, and requires an additional 100 μ L of deionized or distilled water to raise the fluid level for optimal reading.
- **100 μ L Test:** Confirms the performance of the 10 μ L cassettes when dispensing 10 aliquots (2 1/2 turns of pump) into each well of the plate. It dispenses 100 μ L into each well using the solution called **100 μ L solution**, and requires an additional 50 μ L of deionized or distilled water to raise the fluid level for optimal reading.
- **1536 Test:** Confirms the alignment of the tips; that the cassette is firing straight into the wells. Dispenses 6 μ L into columns 2, 4, 19-30, 45, 47 of a 1536-well plate using the "1536 solution." Also requires performing the 1 μ L Test described above.

- **8-to-1 Test:** Confirms the performance of the RAD technology 8- to-1 bulk-dispensing cassette 40 μL /well into a 24-well plate (which is 8 times the full 5 μL tubing increments). Use the **100 μL solution**, and top off the wells with an additional 1080 μL /well of deionized or distilled water to raise the fluid level for optimal reading.

Peri-pump Dispenser Test Materials

- 96-well plates: Corning[®] Costar #3590 or equivalent
- 1536-well plates: Nunc #264710, if applicable
- 24-well plates: Corning[®] Costar #3524, for RAD 8-to-1 cassette
- Precision balance with readability of 0.0001 g resolution is preferable, 0.001 g resolution is acceptable, and capacity of 100 g minimum
- Pipettes and graduated beakers
- Microplate absorbance reader capable of dual wavelength reading at 630 and 450 (or 405) nm
- BioTek blue dye solution, PN 7773001, or equivalent to create the [Peri-pump Dispense Precision and Accuracy Test Solutions below](#).

■ **See [Important Recommendations for All Liquid Tests](#) on page 220.**

Peri-pump Dispenser Precision and Accuracy Test Solutions

Unique concentrations of the test fluid are described here, each one corresponds to a specific dispense volume. Prepare the solutions you will need to validate the cassette types and dispense volumes used most commonly in your applications.

■ The 5 μL Solution is used to make the higher volume test solutions.

1 μL Solution

Using BioTek's 10X concentrated blue dye solution (PN 7773001), mix 5 mL of deionized or distilled water with 8 mL of the blue dye solution.

5 μL Solution

Using BioTek's 10X concentrated blue dye solution (PN 7773001), mix 100 mL of deionized or distilled water with 10 mL of the blue dye solution.

10 μL Solution

Mix 25 mL of DI or dH₂O water with 20 mL of the **5 μL Solution** (described above).

50 µL Solution

Mix 45 mL of DI or dH₂O water with 5 mL of the **5 µL Solution**.

100 µL Solution

Mix 40 mL of DI or dH₂O water with 2 mL of the **5 µL Solution**. (Use this solution to test the RAD 8-to-1 cassette.)

1536 Solution

Mix 5 mL of 70% isopropyl alcohol with 3 mL of the **5 µL Solution** and 35 mL of DI H₂O.



Perform the Peri-Pump Precision and Accuracy Tests**Prerequisite:**

- Gather the [required materials](#).
- Prepare the [test solutions](#).
- Make a copy of the applicable worksheets. Find them on the operator's manual USB stick in the Qualification chapter PDF.

Procedure:

1. Install the cassette to be tested.
2. Turn on the MultiFlo FX and make sure the cassette type setting is correct.
3. Turn on the balance.
4. Fill a beaker or other vessel with the test solution.
5. Define a **Protocol** and save it for reuse. Set the parameters based on the desired test volume:

■ A predefined protocol for the **1536 Test** is shipped with the instrument and installed on your PC when you install the LHC: **QC_P-1536_DISP_TEST** (P2 protocols are designed for the Secondary Peri-pump).

-  Add a dispense step to the protocol: .
- Set the **Dispense Volume** to match the Test:

Test	Volume
1 µL	1 µL

Test	Volume
5 μL	5 μL
10 μL	10 μL
50 μL	50 μL
100 μL	100 μL
1536	6 μL
8-to-1	1120 μL

- Set the **Flow Rate** to High for all protocols except the 1 μL test; use the Medium flow rate for this test.
 - Optionally, choose to **Require** the specific cassette type under test.
 - LHC/Touch screen users: select **Advanced options**: retain the default **Positioning** settings.
 - Define a **Pre-dispense**: set the volume to **10 μL** and the **Number of Pre-dispenses** (cycles) to **2**.
 - **RAD single-tube cassettes**: define the Well Map to dispense to one row only. Then, perform the remaining steps in this procedure on that row only. Remember to calculate the results based on 12 wells, rather than 96.
5. Place a clean/new microplate on the balance and tare the balance.
 6. Put the Tube Organizer into the test fluid vessel and **Prime** the tubing until any large air bubbles are removed.
 7. **Run** the dispense protocol.
 8. Place the plate on the balance and record the **Total Dispense Weight** in the worksheet.
 9. Using a calibrated hand pipette or the Peri-pump, add the specified amount of deionized water to each well to raise the fluid level for optimal reading.

Test	Volume
1 μL	150 μL
5 μL	150 μL
10 μL	100 μL
50 μL	100 μL
100 μL	50 μL
1536	0 μL
8-to-1	0 μL

10. Read the plate in an absorbance reader using the dual-wavelength method: read the plate at 630 nm and 450 nm.
11. Calculate the **Delta OD**: (630 nm - 450 nm), **Mean Absorbance**, **Standard Deviation**, and the **%CV** for the wells under test. **%CV** = (Standard Deviation ÷ Mean) * 100.
12. Print the report, obtain required signatures, and store it according to regulatory guidelines.

If one or more of your tests are failing, make sure the dispense tubes are not clogged, (follow instructions to [Unclog the Dispense Tips on page 194](#)). If that doesn't work, recalibrate the cassette and repeat the test(s). If your tests continue to fail, contact BioTek's Technical Assistance Center (TAC).

Documenting Test Results

Dispense Precision & Accuracy Test Worksheets are provided below. We recommend you make copies of the appropriate pages and use them to record your calculations and test results.

Alternatively, you can purchase the instrument qualification package, which contains additional tools for conducting test procedures and recording the results, including logbooks and Excel® spreadsheets.

Peri-pump Dispense Precision & Accuracy Test Worksheet
1 µL Test for 1 µL Cassette

1 µL Dispense Precision Test	
Standard Deviation (SD):	
Mean Absorbance (sum of all wells ÷ # of wells)	
% CV (SD ÷ Mean x 100)	%
% CV must be < 11.0%	<input type="checkbox"/> Pass <input type="checkbox"/> Fail

1 µL Dispense Accuracy Test	
Total Dispense (Actual) Weight:	grams
Expected Weight: (mL/well x number of wells dispensed)	grams
% Accuracy Error: (Actual Weight – Expected Weight) ÷ Expected Weight x 100	%
% Accuracy Error must be < 10.0%	<input type="checkbox"/> Pass <input type="checkbox"/> Fail
Visual verification that no well varies considerably from the others	<input type="checkbox"/> Pass <input type="checkbox"/> Fail

Cassette Serial Number:	
Tests Performed By:	
Date:	
Reviewed/Approved By:	
Date:	

Peri-pump Dispense Precision & Accuracy Test Worksheet
10 µL Test for 1 µL Cassette

10 µL Dispense Precision Test	
Standard Deviation (SD):	
Mean Absorbance (sum of all wells ÷ # of wells)	
% CV (SD ÷ Mean x 100)	%
% CV must be < 6.0%	<input type="checkbox"/> Pass <input type="checkbox"/> Fail

10 µL Dispense Accuracy Test	
Total Dispense (Actual) Weight:	grams
Expected Weight: (mL/well x number of wells dispensed)	grams
% Accuracy Error: (Actual Weight – Expected Weight) ÷ Expected Weight x 100	%
% Accuracy Error must be < 5.0%	<input type="checkbox"/> Pass <input type="checkbox"/> Fail
Visual verification that no well varies considerably from the others	<input type="checkbox"/> Pass <input type="checkbox"/> Fail

Cassette Serial Number:	
Tests Performed By:	
Date:	
Reviewed/Approved By:	
Date:	

**Peri-pump Dispense Precision & Accuracy Test Worksheet
1536 Test**

1536 Dispense Precision Test	
Standard Deviation (SD):	
Mean Absorbance (sum of all wells ÷ 384)	
% CV (SD ÷ Mean x 100)	%
% CV must be < 6.0%	<input type="checkbox"/> Pass <input type="checkbox"/> Fail

1536 Dispense Accuracy Test	
Total Dispense (Actual) Weight:	grams
Expected Weight: (mL/well x number of wells dispensed)	grams
% Accuracy Error: (Actual Weight – Expected Weight) ÷ Expected Weight x 100	%
% Accuracy Error must be < 5.0%	<input type="checkbox"/> Pass <input type="checkbox"/> Fail
Visual verification that no well varies considerably from the others	<input type="checkbox"/> Pass <input type="checkbox"/> Fail

Cassette Serial Number:	
Tests Performed By:	
Date:	
Reviewed/Approved By:	
Date:	

**Peri-pump Dispense Precision & Accuracy Test Worksheet
5 µL Test**

5 µL Dispense Precision Test	
Standard Deviation (SD):	
Mean Absorbance (sum of all wells ÷ # of wells)	
% CV (SD ÷ Mean x 100)	%
% CV must be < 6.0%	<input type="checkbox"/> Pass <input type="checkbox"/> Fail

5 µL Dispense Accuracy Test	
Total Dispense (Actual) Weight:	grams
Expected Weight: (mL/well x number of wells dispensed)	grams
% Accuracy Error: (Actual Weight – Expected Weight) ÷ Expected Weight x 100	%
% Accuracy Error must be < 4.0%	<input type="checkbox"/> Pass <input type="checkbox"/> Fail
Visual verification that no well varies considerably from the others	<input type="checkbox"/> Pass <input type="checkbox"/> Fail

Cassette Serial Number:	
Tests Performed By:	
Date:	
Reviewed/Approved By:	
Date:	

Peri-pump Dispense Precision & Accuracy Test Worksheet
50 µL Test for 5 µL Cassette

50 µL Dispense Precision Test	
Standard Deviation (SD):	
Mean Absorbance (sum of all wells ÷ # of wells)	
% CV (SD ÷ Mean x 100)	%
% CV must be < 3.50%	<input type="checkbox"/> Pass <input type="checkbox"/> Fail

50 µL Dispense Accuracy Test	
Total Dispense (Actual) Weight:	grams
Expected Weight: (mL/well x number of wells dispensed)	grams
% Accuracy Error: (Actual Weight – Expected Weight) ÷ Expected Weight x 100	%
% Accuracy Error must be < 2.0%	<input type="checkbox"/> Pass <input type="checkbox"/> Fail
Visual verification that no well varies considerably from the others	<input type="checkbox"/> Pass <input type="checkbox"/> Fail

Cassette Serial Number:	
Tests Performed By:	
Date:	
Reviewed/Approved By:	
Date:	

Peri-pump Dispense Precision & Accuracy Test Worksheet
10 µL Test for 10 µL Cassette

10 µL Dispense Precision Test	
Standard Deviation (SD):	
Mean Absorbance (sum of all wells ÷ # of wells)	
% CV (SD ÷ Mean x 100)	%
% CV must be < 5.0%	<input type="checkbox"/> Pass <input type="checkbox"/> Fail

10 µL Dispense Accuracy Test	
Total Dispense (Actual) Weight:	grams
Expected Weight: (mL/well x number of wells dispensed)	grams
% Accuracy Error: (Actual Weight – Expected Weight) ÷ Expected Weight x 100	%
% Accuracy Error must be < 4.0%	<input type="checkbox"/> Pass <input type="checkbox"/> Fail
Visual verification that no well varies considerably from the others	<input type="checkbox"/> Pass <input type="checkbox"/> Fail

Cassette Serial Number:	
Tests Performed By:	
Date:	
Reviewed/Approved By:	
Date:	

**Peri-pump Dispense Precision & Accuracy Test Worksheet
100 µL Test**

100 µL Dispense Precision Test	
Standard Deviation (SD):	
Mean Absorbance (sum of all wells ÷ # of wells)	
% CV (SD ÷ Mean x 100)	%
% CV must be < 3.0%	<input type="checkbox"/> Pass <input type="checkbox"/> Fail

100 µL Dispense Accuracy Test	
Total Dispense (Actual) Weight:	grams
Expected Weight: (mL/well x number of wells dispensed)	grams
% Accuracy Error: (Actual Weight – Expected Weight) ÷ Expected Weight x 100	%
% Accuracy Error must be < 2.0%	<input type="checkbox"/> Pass <input type="checkbox"/> Fail
Visual verification that no well varies considerably from the others	<input type="checkbox"/> Pass <input type="checkbox"/> Fail

Cassette Serial Number:	
Tests Performed By:	
Date:	
Reviewed/Approved By:	
Date:	

**Peri-pump Dispense Precision & Accuracy Test Worksheet
8-to-1 RAD Cassette Test**

100 µL Dispense Precision Test	
Standard Deviation (SD):	
Mean Absorbance (sum of all wells ÷ 24)	
% CV (SD ÷ Mean x 100)	%
% CV must be < 2.5%	<input type="checkbox"/> Pass <input type="checkbox"/> Fail

100 µL Dispense Accuracy Test	
Total Dispense (Actual) Weight:	grams
Expected Weight: (mL/well x number of wells dispensed)	grams
% Accuracy Error: (Actual Weight – Expected Weight) ÷ Expected Weight x 100	%
% Accuracy Error must be < 4.0%	<input type="checkbox"/> Pass <input type="checkbox"/> Fail
Visual verification that no well varies considerably from the others	<input type="checkbox"/> Pass <input type="checkbox"/> Fail

Cassette Serial Number:	
Tests Performed By:	
Date:	
Reviewed/Approved By:	
Date:	

Syringe Dispenser Liquid Tests

Dispense Precision and Accuracy Specifications

- Important:** For **IQ/OQ/PQ** testing purposes 1.0% tolerance has been added to some of the [published specifications](#) for Precision %CV to accommodate variations in test solutions, off-peak wavelengths, reader errors, and pipette errors. % Accuracy Error is calculated for the dispense volume specified in the respective test procedure in adherence to the published specifications.

Test #	Plate Type-Manifold	Precision	Accuracy
2	384-well plate	< 3% CV @ 80 µL/well	< 1.25% @ 80 µL/well
1	16-tube manifold	< 6% CV @ 20 µL/well	< 5% @ 20 µL/well
2	96-well plate	< 3% CV @ 160 µL/well	< 1.25% @ 160 µL/well
1	8- & 16-tube manifold	< 6% CV @ 40 µL/well	< 5% @ 40 µL/well
3	1536-well plate	< 12% CV @ 6 µL/ well	< 5% @ 6 µL/well
	32-tube manifold		

Low-Density-Plate-Specific Manifolds

Dispense Precision		
Refer to the values below for dispense precision when measured in full plates with the specified volume of deionized water with 0.1% Tween 20 and FD&C#1 blue dye solution and read at 630 nm/405 nm.		
Plate Type	Performance	Volume (µL/well)
6-Well	≤6.0% CV	5560
12-Well	≤4.0% CV	2240
24-Well	≤4.0% CV	1120
48-Well	≤4.0% CV	560

Dispense Accuracy is measured gravimetrically when dispensing any volume of room-temperature deionized water using [Flow Rate 2](#). For all plate-specific manifolds, dispense accuracy shall be 2 µL or 1%, whichever is greater.

Syringe Dispenser Test Materials

- Microplates: 384-well plates for testing the 16-tube dispensers (which can be replaced with 96-well plates if more applicable for your lab); 1536-well plates for testing the 32-tube dispensers; and 96-well plates for testing the 8-tube dispensers. For the low-density-plate-type specific manifolds, the applicable plate type is required.
- Precision balance with readability of 0.0001 g resolution is preferable, 0.001 g resolution is acceptable, and capacity of 100 g minimum
- Pipettes and graduated beakers
- Microplate absorbance reader capable of dual wavelength reading at 630 and 405 (or 450) nm
- The test solutions: [Syringe Dispenser Test Solutions below](#).

■ See also [Important Recommendations for All Liquid Tests on page 220](#).

Syringe Dispenser Test Solutions

20 μ L Solution

- Mix 10 mL of BioTek's blue dye solution with 100 mL of deionized or distilled water to create a dilution of the concentrate. Mix 160 mL of deionized or distilled water with 20 mL of the diluted concentrate.

80 μ L Solution

- Mix 120 mL of deionized or distilled water with 40 mL of the **20 μ L Solution**.

1536 Solution

- Mix 21 mL of 70% Isopropyl Alcohol with 13 mL of the **20 μ L Solution** and 150 mL of DI H₂O.

Perform the Syringe Dispense Precision & Accuracy Test

Prerequisites:

- Gather the required materials: [Syringe Dispenser Materials above](#).
- Prepare the test solutions: [Syringe Dispenser Test Solutions above](#).
- Make a copy of the applicable worksheets.

Test Protocols

Two predefined QC protocols are provided for qualifying the 32-tube dispensers. Skip the protocol development steps in the procedure when testing these dispensers:

Onboard Name	Description
SA-1536_DISP_TEST	Dispense precision test protocol for 32-tube Syringe A manifold.
SB-1536_DISP_TEST	Dispense precision test protocol for 32-tube Syringe B manifold.

These predefined protocols dispense 6 μ L/well into 512 wells of a 1536-well plate (columns 2, 4, 19-30, 45, 47). For speed, efficiency and to reduce the amount of alcohol needed, the test is designed for visual inspection of the two columns at each end of the plate, while the block of columns at the center of the plate is used for evaluating dispense precision.

Procedure:

Standard Syringe Manifolds: Perform two tests for each syringe using the applicable plate type and dye solutions. Plate-Type-Specific Manifolds: Perform one test for each syringe using the applicable plate type and the 80 μ L solution.

Standard Syringe Manifolds	Low-Density-Plate-Type-Specific Manifolds
384-well for the 16-tube manifolds (unless only 96-well plates are used in your lab), 1536-well for the 32-tube manifolds, and 96-well for the dual 8-tube manifold.	6-, 12-, 24-, or 48-well plates supported by the manifold.

1. Prepare the syringe dispenser to be tested:

Standard Syringe Manifolds	Plate-Type-Specific Manifolds
<ul style="list-style-type: none"> • Test 1: Use the <u>20 μL solution</u> • Test 2: Use the <u>80 μL solution</u> • Test 3: Use the <u>1536 solution</u> 	<ul style="list-style-type: none"> • Plate-Type Test: Use the <u>80 μL solution</u>

2. Prime the Syringe using your preferred method: run S-DAY_RINSE_A (or B) or use the Quick Dispense menu to remove any air bubbles from the system.
3. Create and save protocols for the tests, **two** for each Syringe, A and B, as follows, except only one test per manifold is required for plate-type-specific

manifolds:

Skip these protocol development steps for the 32-tube dispensers. And, because you will save the protocols, you only need to create them one time for the other manifolds.

1. Define a Dispense step for each test for each manifold, A and B:

Standard Syringe Manifolds

	Manifold Type	Plate Type	Volume ($\mu\text{L}/\text{well}$)	Flow rate	Pre-dispense (2 cyc)
Test 1:	16-Tube	384	20	2	20
	8-Tube	96	40	2	40
Test 2:	16-Tube	384	80	2	80
	8-Tube	96	160	2	160

Plate-Type Specific Manifolds

Parameters	6-Well	12-Well	24-Well	48-Well
Volume ($\mu\text{L}/\text{well}$)	5560	2240	1120	560
Flow Rate	5	5	5	5
Z-axis/Dispense Height	465	460	452	460
Pre-dispense (2 cycles)	320	220	160	320

2. Save the protocol.
4. Place a clean, empty microplate on the balance and tare the balance.
5. Place the microplate on the carrier and run the protocol (created in step 3 or predefined).
6. Place the plate on the balance and record the **Total Dispense Weight**. This value will be used to calculate the % Accuracy Error.
7. **For Test 1 Only:** Use a calibrated hand pipette or the Peri-pump to dispense deionized water on top of the dye solution in the wells.
 - **384-well:** Pipette 60 $\mu\text{L}/\text{well}$ (resulting in 80 $\mu\text{L}/\text{well}$)
 - **96-well:** Pipette 120 $\mu\text{L}/\text{well}$ (resulting in 160 $\mu\text{L}/\text{well}$)

8. Shake the plate using the MultiFlo FX, an orbital shaker or in a microplate reader for 15 seconds, or lightly tap the side of the plate with your finger to agitate the contents of the wells.
9. Read the plate in an absorbance reader using the dual-wavelength method, to reduce the influence of scratches and foreign particles that could be in the well. [See the recommended wavelengths.](#) Print or export the results.
10. Calculate and report the Mean absorbance, Standard Deviation, and the %CV for the wells under test. $\%CV = (\text{Standard Deviation} \div \text{Mean}) * 100$.
11. The **% Accuracy Error** calculation is: $(\text{Actual Weight} - \text{Expected Weight}) \div \text{Expected Weight} * 100$

Subtract the expected dispense weight (see below) from the Actual (Total) Dispense Weight (from step 5), and divide the result by the expected weight. Multiply the result by 100.

The **Expected Dispense Weight** is the volume dispensed per well in mL multiplied by the number of wells dispensed. For example, if 40 μL is dispensed to 96 wells, the expected weight is $0.040 * 96 = 3.84$ grams. We have calculated some expected dispense weights for you:

Test	# of wells	Volume $\mu\text{L}/\text{well}$	Expected Weight
Test 1:	384 wells	20	7.68 grams
	96 wells	40	3.84 grams
Test 2:	384 wells	80	30.72 grams
	96 wells	160	15.36 grams
Test 3:	512 wells (of a 1536-well plate)	6	3.012 grams
Plate-Type Specific Tests			
	6 Well	5560	33.36 grams
	12 Well	2240	26.88 grams
	24 Well	1120	26.88 grams
	48 Well	560	26.88 grams

12. Analyze your test results. The following is the Pass criteria for each test:

Test	%CV	% Accuracy Error
Test 1	< 6.0%	± 5.0%
Test 2	< 3.0%	± 1.25%
Test 3	< 12.0%	± 5.0%
6 Well	< 6.0%	± 1.0%
All other plate-type tests	< 4.0%	± 1.0%

If one or more of your tests are failing, clean the dispense tubes with the stylus, re-prime the manifold, and repeat the test(s). If your tests continue to fail, contact BioTek's Technical Assistance Center.

Documenting Test Results

Dispense Precision & Accuracy Test Worksheets are provided on the MultiFlo FX Operator's Manual USB flash drive in the Qualification chapter PDF. We recommend you make copies of the appropriate pages and use them to record your calculations and test results.

Each worksheet records calculations and pass/fail test results for an individual test.

Syringe Dispenser Precision & Accuracy Test Worksheet

Test 1 / 96-Well Microplate/40 µL Dispense

40 µL Dispense Precision Test	
Standard Deviation (SD):	
Mean Absorbance (sum of all wells ÷ 96)	
% CV (SD ÷ Mean x 100)	%
% CV must be < 6.0%	<input type="checkbox"/> Pass <input type="checkbox"/> Fail

40 µL Dispense Accuracy Test	
Total Dispense (Actual) Weight:	grams
Expected Weight: (mL/well x number of wells dispensed)	grams
% Accuracy Error: (Actual Weight – Expected Weight) ÷ Expected Weight x 100	%
% Accuracy Error must be < 5.0%	<input type="checkbox"/> Pass <input type="checkbox"/> Fail
Visual verification that no well varies considerably from the others	<input type="checkbox"/> Pass <input type="checkbox"/> Fail

Serial Number:	
Tests Performed By:	
Date:	
Reviewed/Approved By:	
Date:	

Syringe Dispenser Precision & Accuracy Test Worksheet

Test 2 / 96-Well Microplate/160 µL Dispense

160 µL Dispense Precision Test	
Standard Deviation (SD):	
Mean Absorbance (sum of all wells ÷ 96)	
% CV (SD ÷ Mean x 100)	%
% CV must be < 3.0%	<input type="checkbox"/> Pass <input type="checkbox"/> Fail

160 µL Dispense Accuracy Test	
Total Dispense (Actual) Weight:	grams
Expected Weight: (mL/well x number of wells dispensed)	grams
% Accuracy Error: (Actual Weight – Expected Weight) ÷ Expected Weight x 100	%
% Accuracy Error must be < 1.25%	<input type="checkbox"/> Pass <input type="checkbox"/> Fail
Visual verification that no well varies considerably from the others	<input type="checkbox"/> Pass <input type="checkbox"/> Fail

Serial Number:	
Tests Performed By:	
Date:	
Reviewed/Approved By:	
Date:	

Syringe Dispenser Precision & Accuracy Test Worksheet

Test 1 / 384-Well Microplate / 20 µL Dispense

20 µL Dispense Precision Test	
Standard Deviation (SD):	
Mean Absorbance (sum of all wells ÷ 384)	
% CV (SD ÷ Mean x 100)	%
% CV must be < 6.0%	<input type="checkbox"/> Pass <input type="checkbox"/> Fail

20 µL Dispense Accuracy Test	
Total Dispense (Actual) Weight:	grams
Expected Weight: (mL/well x number of wells dispensed)	grams
% Accuracy Error: (Actual Weight – Expected Weight) ÷ Expected Weight x 100	%
% Accuracy Error must be < 5.0%	<input type="checkbox"/> Pass <input type="checkbox"/> Fail
Visual verification that no well varies considerably from the others	<input type="checkbox"/> Pass <input type="checkbox"/> Fail

Serial Number:	
Tests Performed By:	
Date:	
Reviewed/Approved By:	
Date:	

Syringe Dispenser Precision & Accuracy Test Worksheet

Test 2 / 384-Well Microplate / 80 µL Dispense

80 µL Dispense Precision Test	
Standard Deviation (SD):	
Mean Absorbance (sum of all wells ÷ 384)	
% CV (SD ÷ Mean x 100)	%
% CV must be < 3.0%	<input type="checkbox"/> Pass <input type="checkbox"/> Fail

80 µL Dispense Accuracy Test	
Total Dispense (Actual) Weight:	grams
Expected Weight: (mL/well x number of wells dispensed)	grams
% Accuracy Error: (Actual Weight – Expected Weight) ÷ Expected Weight x 100	%
% Accuracy Error must be < 1.25%	<input type="checkbox"/> Pass <input type="checkbox"/> Fail
Visual verification that no well varies considerably from the others	<input type="checkbox"/> Pass <input type="checkbox"/> Fail

Serial Number:	
Tests Performed By:	
Date:	
Reviewed/Approved By:	
Date:	

Syringe Dispenser Precision & Accuracy Test Worksheet

Test 3 / 1536-Well Microplate / 6 µL Dispense

6 µL Dispense Precision Test	
Standard Deviation (SD):	
Mean Absorbance (sum of all wells ÷ 384)	
% CV (SD ÷ Mean x 100)	%
% CV must be < 12.0%	<input type="checkbox"/> Pass <input type="checkbox"/> Fail

6 µL Dispense Accuracy Test	
Total Dispense (Actual) Weight:	grams
Expected Weight: (mL/well x number of wells dispensed)	grams
% Accuracy Error: (Actual Weight – Expected Weight) ÷ Expected Weight x 100	%
% Accuracy Error must be < 5.0%	<input type="checkbox"/> Pass <input type="checkbox"/> Fail
Visual verification that no well varies considerably from the others	<input type="checkbox"/> Pass <input type="checkbox"/> Fail

Serial Number:	
Tests Performed By:	
Date:	
Reviewed/Approved By:	
Date:	

Dispense Precision and Accuracy Test Worksheet

6-Well-Plate Syringe Manifold

Serial Number:	
----------------	--

Dispense Precision Test	
Standard Deviation: (calculate using spreadsheet program)	
Mean OD: (sum of all wells ÷ 6 wells)	
% Coefficient of Variation: ((Standard Deviation ÷ Mean OD) x 100)	
% CV ≤ 6.0?	<input type="checkbox"/> Pass <input type="checkbox"/> Fail

Dispense Accuracy Test	
Total Dispense (Actual) Weight:	grams
Expected Weight: (μL/well x number of wells dispensed)	grams
% Accuracy Error: (Actual Weight – Expected Weight) ÷ Expected Weight x 100	%
% Accuracy Error must be ≤ ±1.0%	<input type="checkbox"/> Pass <input type="checkbox"/> Fail
Visual verification that no well varies considerably from the others	<input type="checkbox"/> Pass <input type="checkbox"/> Fail

Date:	
Test Performed By:	

Dispense Precision and Accuracy Test Worksheet

12-Well-Plate Syringe Manifold

Serial Number:	
----------------	--

Dispense Precision Test	
Standard Deviation: (calculate using spreadsheet program)	
Mean OD: (sum of all wells ÷ 12 wells)	
% Coefficient of Variation: ((Standard Deviation ÷ Mean OD) x 100)	
% CV ≤ 4.0?	<input type="checkbox"/> Pass <input type="checkbox"/> Fail

Dispense Accuracy Test	
Total Dispense (Actual) Weight:	grams
Expected Weight: (μL/well x number of wells dispensed)	grams
% Accuracy Error: (Actual Weight – Expected Weight) ÷ Expected Weight x 100	%
% Accuracy Error must be ≤ ±1.0%	<input type="checkbox"/> Pass <input type="checkbox"/> Fail
Visual verification that no well varies considerably from the others	<input type="checkbox"/> Pass <input type="checkbox"/> Fail

Date:	
Test Performed By:	

Dispense Precision and Accuracy Test Worksheet

24-Well-Plate Syringe Manifold

Serial Number:	
----------------	--

Dispense Precision Test	
Standard Deviation: (calculate using spreadsheet program)	
Mean OD: (sum of all wells ÷ 24 wells)	
% Coefficient of Variation: ((Standard Deviation ÷ Mean OD) x 100)	
% CV ≤ 4.0?	<input type="checkbox"/> Pass <input type="checkbox"/> Fail

Dispense Accuracy Test	
Total Dispense (Actual) Weight:	grams
Expected Weight: (μL/well x number of wells dispensed)	grams
% Accuracy Error: (Actual Weight – Expected Weight) ÷ Expected Weight x 100	%
% Accuracy Error must be ≤ ±1.0%	<input type="checkbox"/> Pass <input type="checkbox"/> Fail
Visual verification that no well varies considerably from the others	<input type="checkbox"/> Pass <input type="checkbox"/> Fail

Date:	
Test Performed By:	

Dispense Precision and Accuracy Test Worksheet

48-Well-Plate Syringe Manifold

Serial Number:	
----------------	--

Dispense Precision Test	
Standard Deviation: (calculate using spreadsheet program)	
Mean OD: (sum of all wells ÷ 48 wells)	
% Coefficient of Variation: ((Standard Deviation ÷ Mean OD) x 100)	
% CV ≤ 4.0?	<input type="checkbox"/> Pass <input type="checkbox"/> Fail

Dispense Accuracy Test	
Total Dispense (Actual) Weight:	grams
Expected Weight: (μL/well x number of wells dispensed)	grams
% Accuracy Error: (Actual Weight – Expected Weight) ÷ Expected Weight x 100	%
% Accuracy Error must be ≤ ±1.0%	<input type="checkbox"/> Pass <input type="checkbox"/> Fail
Visual verification that no well varies considerably from the others	<input type="checkbox"/> Pass <input type="checkbox"/> Fail

Date:	
Test Performed By:	

Washer Qualification Liquid Tests

Dispense Precision and Accuracy Test

Dispense precision is a measure of the variability of volumes dispensed from tube to tube across the manifold. The optical density of the solution in a well is proportional to the total volume of the solution in the well. If the % Coefficient of Variation (%CV) is calculated, the result is a measure of the uniformity of the distribution of dispensed volumes across the manifold. It is the ratio, expressed in percent, of the standard deviation of the distribution of fluid volumes in the wells to the mean value of volume per well. The uniformity of distribution across the manifold improves as the %CV is lowered.

Dispense accuracy is a measure of the average volume dispensed per well. It is independent of precision. The volume per well may vary greatly over a plate, yet the accuracy may be exact because it is an average of the volumes.

- **Important:** For **IQ/OQ/PQ** testing purposes 1.0% tolerance has been added to some of the [published specifications](#) for Precision %CV to accommodate variations in test solutions, off-peak wavelengths, reader errors, and pipette errors. % Accuracy Error is calculated for the dispense volume specified in the respective test procedure in adherence to the published specifications.

Evacuation Efficiency Test

The Evacuation Efficiency test measures the **residual volume** (mean residual weight) per well after aspiration is performed. The lower the residual per well, the better the evacuation efficiency of the washer. A known solution is dispensed into all wells of a previously weighed microplate. Aspiration is performed and the plate is re-weighed. The total residual fluid is calculated based on the weight difference, and this value is divided by number of wells in the plate, to obtain the **mean residual weight**.

In addition, a diagnostic tool is provided for use, if necessary, to identify problem wells: a known dye concentration is dispensed to and evacuated from the wells, and the plate is weighed. Buffer is then dispensed to all wells to bring the volume of fluid to a more optically measurable volume. The optical density (OD) of each well is measured and the background is subtracted to account for scratches on the plate or particulates in a well. Each well's residual volume is calculated using its OD and a calibration factor derived from the mean residual weight and the mean

OD of all wells on the plate. It is assumed that 1 mg = 1 μ L of fluid for this calculation.

Washer Qualification Test Materials

- One new microplate per test to be performed:

Microplate Type
Flat-bottom 96-well plates, Corning® Costar #3590 or equivalent
Flat-bottom 384-well plates, Corning Costar #3574 or equivalent
Flat-bottom 48-well plates, Corning Costar #3548 or equivalent
Flat-bottom 24-well plates, Corning Costar #3524 or equivalent
Flat-bottom 12-well plates, Corning Costar #3513 or equivalent
Flat-bottom 6-well plates, Corning Costar #3516 or equivalent

- Precision balance with minimum capacity of 100 g and readability of 0.001 g resolution
- Pipettes and graduated beakers
- Microplate absorbance reader capable of dual wavelength reading at 630/450 nm
- **Liquid Test Worksheets** at the end of this chapter for recording data and results
- Deionized or distilled water
- **Test solutions** *described below*

■ These volumes are sufficient for performing the dispense tests and standard and diagnostic Evacuation Efficiency tests with enough fluid remaining to re-run a test, if necessary.

Test Solutions

Solution #1: Buffer Solution		
Pipette 1 mL Tween 20® into 1 liter (1000 mL) of deionized or distilled water and mix well.	or	Pipette 10 mL of BioTek Wetting Agent* into 1 liter of deionized or distilled water and mix well.

* BioTek Solution #1 100X Concentrate Wetting Agent 125 mL (PN 7773002) contains 10% Tween 20 in deionized water and 0.01% Sodium Azide as a preservative.

SOLUTION #2: Residual Test Solution

Mix 100 mL of **Solution #1** with 0.050 grams of FD&C #1 blue dye.

or

Mix 90 mL of **Solution #1** with 10 mL of BioTek Blue Test Dye*.

* BioTek Solution #2 10X Concentrate Blue Test Dye 125 mL (PN 7773001) contains 5 grams per liter FD&C Blue #1, 0.1% Tween 20 in deionized water and 0.01% Sodium Azide as a preservative.

SOLUTION #3: Dispense Precision and Accuracy Solution

Mix 1180 mL of deionized or distilled water with 20 mL of **Solution #2**.

Create Washer Qualification Protocols



1. Select **Maintenance** at the Home screen, and then **Define**.
2. Press **Create**.
3. Press the **Name** field and assign a unique name, e.g. 6-Well Dispense Test.
4. **Plate Type**: select the appropriate plate type for the test and press **OK**.
5. **Add** steps with the recommended parameters (shown below):
 - Add a **W-Dispense** step for the Dispense Precision and Accuracy test and **W-Aspirate** step for the Evacuation Efficiency test.
 - Press **Advanced Options** to define the Z-axis, Pre-Dispense, and other parameters.
6. Press **Save** to save the protocol for future use.



Dispense Precision and Accuracy Protocols

Parameters	6-Well	12-Well	24-Well	48-Well	384-well
Volume (µL/well)	5560	2240	1120	560	80

Parameters	6-Well	12-Well	24-Well	48-Well	384-well
Flow Rate	5	5	5	5	5
Z-axis/Dispense Height	465	460	452	460	333
Pre-dispense	For all manifold types enable and set its Volume to 300 μ L and Number of cycles to 2 .				

Retain default values for all other parameters.

Evacuation Efficiency Protocols

Parameters	6-Well	12-Well	24-Well	48-Well
Travel Rate	0	1	1	1
Z-axis	45	51	51	42
X-axis	350	222	150	96

Retain default values for all other parameters.

Dispense Precision and Accuracy Test

- Find a list of the supplies you will need at [Materials on page 251](#).
- **Save the plate!** When this test is complete, use the filled plate to perform the Evacuation Efficiency Test.
- **Prerequisite for plate types other than 96-Well:** Create the protocols needed to test your manifold. [See Create Washer Qualification Protocols on the previous page](#). One time only! (Predefined protocols are provided with the instrument qualification package (PN 1260521).

1. Fill a supply bottle with 2 liters of deionized or distilled water and run the **W-DAY_RINSE** protocol once or twice to flush the fluid lines and manifold.
2. Fill a supply bottle with 1200 mL of **Solution #3**.
3. Run **W-DAY_RINSE** again to prime the washer with the solution.
4. Place a new microplate on the balance and zero the balance.
5. Place the plate on the carrier and run the **QC_96_DISP_TEST** or the protocol you created for your manifold. The protocol dispenses solution to each well of the plate. It does not evacuate the solution.

6. When the protocol is completed, carefully remove the plate. Place the plate on the balance and record the **Total Dispense Weight**.
7. Read the plate in an optical reader (blank on air), using the dual-wavelength method (630 nm - 450 nm), then print or export the results.
8. Use the **Dispense Precision Test Worksheet** to perform data reduction:

Tip: If you have a spreadsheet software program, enter/export all 96 values into a spreadsheet and apply your program's Standard Deviation function (e.g., Microsoft® Excel's STDEV).

- a. Calculate the **Standard Deviation**.
- b. Calculate the sum of the OD values for all wells, then divide by **number of wells**, e.g. **96**, to determine the **Mean OD** for the plate.
- c. Calculate the **%CV**: (Standard Deviation / Mean OD) * 100.

The %CV should be **<= 4.0**,

except for 6-well plates the %CV should be **<= 6.0**.

If the %CV is *greater than 3.0*, one or more dispense tubes may need to be cleaned. Remove the manifold and use the stylus to clean the dispense tube(s) giving lower-than-average absorbance readings. When finished, re-prime the washer and retry the test.

9. When finished, prime with deionized water to flush out the dye solution.

Evacuation Efficiency Test

■ **Save the plate!** When this test is complete, use the plate to perform the Shake Test for the OQ, if applicable.

■ **Prerequisite for plate types other than 96-Well:** Create the protocols needed to test your manifold. [See Create Washer Qualification Protocols on page 252](#). One time only! (Predefined protocols are provided with the instrument qualification package (PN 1260521).

■ If you tared the balance at the start of the **Dispense Precision and Accuracy Test**, use the plate from that test here; skip steps 1-3.

1. Fill a supply bottle with 2 liters of deionized or distilled water. Run the Maintenance program **W-DAY_RINSE** two or three times to prime the tubing and manifold.

2. Place a new 96-well microplate on the balance and zero the balance.
3. Pipette or dispense specified volume of **Solution #1** into each well of the microplate:

Plate Type	Volume ($\mu\text{L}/\text{well}$)
96 Well	300
6 Well	5560
12 Well	2240
24 Well	1120
48 Well	560

4. Place the plate on the carrier and run the **W-96_EVAC_TEST** protocol or the protocol you created for your manifold. This protocol evacuates the wells, leaving a small amount of residual fluid.
5. When the program is completed, remove the plate and weigh it immediately because evaporation will affect the results. This is the **Total Residual Weight** in grams.
6. Visually inspect the plate and note if any wells appear to have considerably more liquid than others.
7. Use the [Evacuation Efficiency Test Worksheet](#) to perform data reduction:
 - Divide the **Total Residual Weight** by **number of wells** to find the **Mean Residual Weight**.
 - The Mean Residual Weight should be \leq .

Plate Type	Expected Mean Residual Weight
96 Well	0.002 g
6 Well	0.6 g
12 Well	0.15 g
24 Well	0.05 g
48 Well	0.025 g

If the Mean Residual Weight is *greater than* expected, or if one or more wells appear to have much more liquid than the others, the washer failed the test.

Troubleshoot as follows:If the test fails once:

- If the problem appears to be related to particular wells, clean those aspiration tubes: remove the manifold and thoroughly clean the tubes with the stylus ([See **Clean the Dispense/Aspirate Tubes on page 202**](#)). When finished, retry the test.
- Failure of this test is commonly caused by improper aspiration tube placement within the wells, usually because a microplate other than the recommended Corning Costar[®] was used. If you must use a plate *other than* a Corning Costar, modify the Aspirate Height, i.e., Z position, or horizontal X or Y position parameters in a copy of the protocol to correct this error. After making this change, retry the test using a new microplate.

If the test fails a second time: For 96-well plates, perform the *Evacuation Diagnostic Test*. All other plate types, closely examine the residual volume in each well to identify which aspirate tube(s) are clogged.

Evacuation Diagnostic Test

■ Conduct this test if the standard Evacuation Efficiency Test fails **twice** when using a **96-well** plate. This test will confirm which aspirate tube(s) may be clogged, or if the plate's alignment or position is the problem. For all other plate types, a close examination of the residual volume in each well will identify which aspirate tube(s) are clogged.

1. If you have not already done so, repeat steps 2 through 7 of the standard Evacuation Efficiency test, using **Solution #2** for the dispense fluid. Be sure to recalculate the **Mean Residual Weight**.
2. Pipette **Solution #1** into each well, on top of the residual solution: up to 300 μL /well in a 96-well plate or 100 μL /well in a 384-well plate.
3. Shake the plate to achieve uniform distribution of the remaining dye in each well.
4. Read the plate in an optical reader (blank on air), using the dual-wavelength method (630 nm - 450 nm), then print or export the results.
5. Use the **Evacuation Efficiency Test Worksheet** to perform data reduction:
 - Calculate the sum of the OD values for all wells, then divide by **the number of wells** to determine the **Mean OD** for the plate.
 - Divide the Mean OD by the **Mean Residual Weight** (from step 1), to find the **Residual Factor**.

- For each well, divide its OD value by the Residual Factor to find its **Residual Weight**.

Each well's Residual Weight should be ≤ 0.002 g.

If one or more wells have a Residual Weight *greater than* 0.002 g, review the data to determine which well, or wells, is causing the problem.

- If the problem appears to be related to particular wells, clean the associated aspiration tubes: remove the manifold and thoroughly clean the tubes with the stylus, and repeat the test.
- If the problem appears to be related to a particular region, edge, or corner of the plate, review the alignment and flatness of the plate on the carrier.
- For additional suggestions, [See **Troubleshooting on page 272**](#).
- If the test continues to fail, contact BioTek Instruments.

Dispense Precision and Accuracy Test Worksheet

96/384-Well Manifold

96-Well Microplate

Serial Number:	
----------------	--

Dispense Precision Test	
Standard Deviation: (calculate using spreadsheet program)	
Mean OD: (sum of all wells ÷ number of wells)	
% Coefficient of Variation: ((Standard Deviation ÷ Mean OD) x 100)	
% CV ≤ 3.0?	<input type="checkbox"/> Pass <input type="checkbox"/> Fail

Dispense Accuracy Test	
Total Dispense (Actual) Weight:	grams
Expected Weight: (mL/well x number of wells dispensed)	grams
% Accuracy Error: (Actual Weight – Expected Weight) ÷ Expected Weight x 100	%
% Accuracy Error must be ≤ ±3.0%	<input type="checkbox"/> Pass <input type="checkbox"/> Fail
Visual verification that no well varies considerably from the others	<input type="checkbox"/> Pass <input type="checkbox"/> Fail

Date:	
Test Performed By:	

Evacuation Efficiency Test Worksheet

96/384-Well Manifold 96-Well Plate

Serial Number:	
----------------	--

Standard Test	
Total Residual Weight:	g
Verification that wells are consistent in appearance:	<input type="checkbox"/> Pass <input type="checkbox"/> Fail
Mean Residual Weight (Total Residual Weight ÷ 96):	g
Mean Residual Weight ≤ 0.002 g?	<input type="checkbox"/> Pass <input type="checkbox"/> Fail

Evacuation Diagnostics Test (check here <input type="checkbox"/> if not performed)	
Mean OD for the plate (Sum of all wells ÷ 96):	
Residual Factor (Mean OD ÷ Mean Residual Weight):	
Calculate the Residual Weight for each well: well OD ÷ Residual Factor	
Every Residual Weight per well ≤ 0.002 g?	<input type="checkbox"/> Yes <input type="checkbox"/> No

Date:	
Test Performed By:	

Dispense Precision and Accuracy Test Worksheet

96/384-Well Manifold 384-Well Plate

Serial Number:	
----------------	--

Dispense Precision Test	
Standard Deviation: (calculate using spreadsheet program)	
Mean OD: (sum of all wells ÷ number of wells)	
% Coefficient of Variation: ((Standard Deviation ÷ Mean OD) x 100)	
% CV <= 4.0?	<input type="checkbox"/> Pass <input type="checkbox"/> Fail

Dispense Accuracy Test	
Total Dispense (Actual) Weight:	grams
Expected Weight: (mL/well x number of wells dispensed)	grams
% Accuracy Error: (Actual Weight – Expected Weight) ÷ Expected Weight x 100	%
% Accuracy Error must be ≤ ±3.0%	<input type="checkbox"/> Pass <input type="checkbox"/> Fail
Visual verification that no well varies considerably from the others	<input type="checkbox"/> Pass <input type="checkbox"/> Fail

Date:	
Test Performed By:	

Dispense Precision and Accuracy Test Worksheet

6-Well Manifold

Serial Number:	
----------------	--

Dispense Precision Test	
Standard Deviation: (calculate using spreadsheet program)	
Mean OD: (sum of all wells ÷ 6 wells)	
% Coefficient of Variation: ((Standard Deviation ÷ Mean OD) x 100)	
% CV ≤ 6.0?	<input type="checkbox"/> Pass <input type="checkbox"/> Fail

Dispense Accuracy Test	
Total Dispense (Actual) Weight:	grams
Expected Weight: (μL/well x number of wells dispensed)	grams
% Accuracy Error: (Actual Weight – Expected Weight) ÷ Expected Weight x 100	%
% Accuracy Error must be ≤ ±3.0%	<input type="checkbox"/> Pass <input type="checkbox"/> Fail
Visual verification that no well varies considerably from the others	<input type="checkbox"/> Pass <input type="checkbox"/> Fail

Date:	
Test Performed By:	

Evacuation Efficiency Test Worksheet

6-Well Manifold

Serial Number:	
----------------	--

Standard Test	
Total Residual Weight:	g
Verification that wells are consistent in appearance:	<input type="checkbox"/> Pass <input type="checkbox"/> Fail
Mean Residual Weight (Total Residual Weight ÷ 6):	g
Mean Residual Weight ≤ 0.6 g?	<input type="checkbox"/> Pass <input type="checkbox"/> Fail

Date:	
Test Performed By:	

Dispense Precision and Accuracy Test Worksheet

12-Well Manifold

Serial Number:	
----------------	--

Dispense Precision Test	
Standard Deviation: (calculate using spreadsheet program)	
Mean OD: (sum of all wells ÷ 12 wells)	
% Coefficient of Variation: ((Standard Deviation ÷ Mean OD) x 100)	
% CV ≤ 4.0?	<input type="checkbox"/> Pass <input type="checkbox"/> Fail

Dispense Accuracy Test	
Total Dispense (Actual) Weight:	grams
Expected Weight: (μL/well x number of wells dispensed)	grams
% Accuracy Error: (Actual Weight – Expected Weight) ÷ Expected Weight x 100	%
% Accuracy Error must be ≤ ±3.0%	<input type="checkbox"/> Pass <input type="checkbox"/> Fail
Visual verification that no well varies considerably from the others	<input type="checkbox"/> Pass <input type="checkbox"/> Fail

Date:	
Test Performed By:	

Evacuation Efficiency Test Worksheet

12-Well Manifold

Serial Number:	
----------------	--

Standard Test	
Total Residual Weight:	g
Verification that wells are consistent in appearance:	<input type="checkbox"/> Pass <input type="checkbox"/> Fail
Mean Residual Weight (Total Residual Weight ÷ 12):	g
Mean Residual Weight ≤ 0.15 g?	<input type="checkbox"/> Pass <input type="checkbox"/> Fail

Date:	
Test Performed By:	

Dispense Precision and Accuracy Test Worksheet

24-Well Manifold

Serial Number:	
----------------	--

Dispense Precision Test	
Standard Deviation: (calculate using spreadsheet program)	
Mean OD: (sum of all wells ÷ 24 wells)	
% Coefficient of Variation: ((Standard Deviation ÷ Mean OD) x 100)	
% CV ≤ 4.0?	<input type="checkbox"/> Pass <input type="checkbox"/> Fail

Dispense Accuracy Test	
Total Dispense (Actual) Weight:	grams
Expected Weight: (μL/well x number of wells dispensed)	grams
% Accuracy Error: (Actual Weight – Expected Weight) ÷ Expected Weight x 100	%
% Accuracy Error must be ≤ ±3.0%	<input type="checkbox"/> Pass <input type="checkbox"/> Fail
Visual verification that no well varies considerably from the others	<input type="checkbox"/> Pass <input type="checkbox"/> Fail

Date:	
Test Performed By:	

Evacuation Efficiency Test Worksheet

24-Well Manifold

Serial Number:	
----------------	--

Standard Test	
Total Residual Weight:	g
Verification that wells are consistent in appearance:	<input type="checkbox"/> Pass <input type="checkbox"/> Fail
Mean Residual Weight (Total Residual Weight ÷ 24):	g
Mean Residual Weight ≤ 0.05 g?	<input type="checkbox"/> Pass <input type="checkbox"/> Fail

Date:	
Test Performed By:	

Dispense Precision and Accuracy Test Worksheet

48-Well Manifold

Serial Number:	
----------------	--

Dispense Precision Test	
Standard Deviation: (calculate using spreadsheet program)	
Mean OD: (sum of all wells ÷ 48 wells)	
% Coefficient of Variation: ((Standard Deviation ÷ Mean OD) x 100)	
% CV ≤ 4.0?	<input type="checkbox"/> Pass <input type="checkbox"/> Fail

Dispense Accuracy Test	
Total Dispense (Actual) Weight:	grams
Expected Weight: (μL/well x number of wells dispensed)	grams
% Accuracy Error: (Actual Weight – Expected Weight) ÷ Expected Weight x 100	%
% Accuracy Error must be ≤ ±3.0%	<input type="checkbox"/> Pass <input type="checkbox"/> Fail
Visual verification that no well varies considerably from the others	<input type="checkbox"/> Pass <input type="checkbox"/> Fail

Date:	
Test Performed By:	

Evacuation Efficiency Test Worksheet

48-Well Manifold

Serial Number:	
----------------	--

Standard Test	
Total Residual Weight:	g
Verification that wells are consistent in appearance:	<input type="checkbox"/> Pass <input type="checkbox"/> Fail
Mean Residual Weight (Total Residual Weight ÷ 48):	g
Mean Residual Weight ≤ 0.025 g?	<input type="checkbox"/> Pass <input type="checkbox"/> Fail

Date:	
Test Performed By:	

Troubleshooting

This chapter provides guidelines for error recovery and troubleshooting performance problems.

Troubleshooting	272
------------------------------	------------

Troubleshooting

Error recovery:

First Response: Run a System Test (restart the instrument) to give the instrument an opportunity to restore its initial settings and communication capability.

LHC Users: Reboot your Computer and Instrument: When you cannot run a system test, e.g. LHC is not responding, or when running a system test doesn't resolve the issue, turn off your computer and MultiFlo FX, check all the cabling, i.e. make sure your serial or USB cable is in good condition and is properly connected to the PC and instrument, and then, power them on. This should refresh the devices and reset communication parameters.

Error Codes

To find a specific error code:

- [Software Error Codes on page 294](#) (6000-6200) - protocol errors
- [System Error Codes on page 284](#) (0000-A500) - hardware errors

Most error conditions generate an error message that is displayed on the computer screen or keypad.

The most common error for new MultiFlo FX users is easily fixed:

306	Peri-pump Pump Cover is open. Close the pump cover and re-run protocol.
-----	---

To run the Peri-pump, its pump cover must be closed, protecting both the pump and the operator.

401	Carrier Y motor failed positional verify
-----	--

If the plate carrier is not installed correctly, this instrument error will be displayed. Make sure the back right corner of the carrier is correctly seated in the little black knob attached to the transport rail. A slit on the bottom of the carrier allows it to fit into place.

BioStack Errors: To recover from a BioStack error, remove the plate from the BioStack's tray, if applicable, and Home the stacker using the alignment utility: select **Instrument>BioStack** from the Home screen. Press **BioStack Alignment** and then **Home**.



Technical Note: Only one of the two communication ports (COM port) on the instrument can be used at a time. They cannot be used simultaneously. You

can use USB to connect the MultiFlo FX to the computer or the RS232 serial port to connect to a BioStack or similar robotic device. But you cannot use both ports simultaneously, i.e. make sure only one cable is plugged in at a time.

Syringe Dispenser Troubleshooting

- [Dispense Manifold Movement below](#)
- [Fluid Delivery on the next page](#)
- [Fluid Leakage on page 276](#)
- [Syringe Movement on page 277](#)
- [Microplate Carrier Movement on page 276](#)

Startup

Problem	Possible Cause	What To Do
Syringe or manifold position error.	Syringe or manifold is being obstructed.	Remove obstruction.
	Motor, sensor, or electrical problem.	Turn instrument off, wait at least 15 seconds, turn it back on and run a Quick Dispense routine, e.g. Prime. If the problem persists, contact BioTek TAC.
	Syringe piston not seated all the way to the bottom before fastening set screw.	Reinstall the syringe head.

Dispense Manifold Movement

Problem	Possible Cause	What To Do
Manifold position error.	Manifold movement is blocked.	Increase the Plate Clearance height setting. Allow at least 1 mm clearance above plate.
		Check for/remove any obstructions.
		Contact BioTek TAC.

Fluid Delivery

Problem	Possible Cause	What To Do
Unable to dispense fluid.	Inlet tube not connected at manifold or at bottle.	Check all tubing.
	Supply tube inside the supply bottle is kinked or disconnected.	Straighten or connect supply tube. Optimize Performance on page 98
	Clogged dispense tubes on the manifold.	Remove and clean the manifold.
	Inlet tube is not connected to the bottom port of the syringe.	Connect the inlet tube to the lower port of the syringe pump.
	Outlet tube is not connected to the top port of the syringe.	Connect the outlet tube to the top port of the syringe pump.
	Check valve flow direction is incorrect.	Compare the flow direction of the check valves, See Syringe Dispenser Check Valves on page 70 .
	Check valves are stuck closed.	Clean or Replace the Check Valves on page 204
	No fluid.	Fill bottles with appropriate fluid.
	System not primed.	Run S-DAY_RINSE once or twice for one or both syringes.
	Highly viscous fluid.	Apply a Pump Delay to improve performance when dispensing highly viscous fluid, i.e. edit the dispense or prime step to set a 500 msec. delay.
	Faulty syringe pump.	Contact BioTek TAC.
	Set screw not tightened on the syringe pump piston.	Reinstall the syringe head.
Plate overfills (floods).	Dispense height too high.	Change the Dispense Z-axis position (height).

Problem	Possible Cause	What To Do
	Volume too large for the vessel.	Define a smaller volume.
	Dispense rate too fast for volume selected.	Define a slower dispense rate or lower volume.
Uneven dispensing of fluid; wells not filled.	Clogged dispense tubes on the dispenser manifold.	Clean the Syringe Dispenser Manifold on page 201
	Manifold or tubing not adequately primed (air in fluid lines).	Run a Prime using 20 mL. Follow with a Dispense: 20 μ L per well for 24 strips.
	Dispense flow rate too low.	Define a higher flow rate.
	Setscrew not tightened on the syringe pump piston.	Reinstall the syringe head as described in Autoclave the Syringe Head on page 204
	32-tube dispense manifolds are not dispensing accurately.	Calibrate the Backlash for Syringe Dispenser on page 212
	Highly viscous fluid.	Apply a Pump Delay to improve performance when dispensing highly viscous fluid, i.e. edit the dispense or prime step to set a 500 msec. delay.
Dripping dispense tubes.	Dispense tubing routed incorrectly.	The supply bottle tube must connect to the Syringe's bottom port.
Fluid jet is off-center or skewed from 32-tube SB manifold.	Minute particles of debris on the end of the tubes.	Brush away any particles from the end of the tube using a piece of silicon tubing. Silicon will not flake off and leave particles behind like other materials.

Fluid Leakage

Problem	Possible Cause	What To Do
Fluid leaking from manifold.	Defective seals.	Maintaining the Syringe Dispenser
	Check valves are leaking.	Clean or Replace the Check Valves on page 204
	Fittings to manifold are leaking.	Reconnect/reseat the fittings.
Fluid leaking from underneath the unit.	Defective syringe cup.	Contact BioTek TAC.
	Leaking syringe seal.	
	Defective syringe piston.	
Fluid leaking from external tubing connector.	Worn tubing.	Replace tubing.
	Defective connector.	Contact BioTek TAC.

Microplate Carrier Movement

Problem	Possible Cause	What To Do
Dispense tubes not entering well correctly.	Microplate not properly seated or strips not level.	Reseat microplate carrier, or the plate or strips in holder.
		Make sure the carrier is clean.
	Horizontal dispense position does not align the tubes in the wells.	Change the X-axis (horizontal) Position in the protocol.
	Dispense tube(s) bent.	Push the supplied stylus into the tube and then gently attempt to straighten the tube using your fingers. If it remains bent, contact BioTek TAC.
	Manifold tilted.	Check tubing for twists.
Carrier position error.	Carrier movement is blocked.	Check for/remove any obstruction.
	Dirty carrier or carrier rail.	Clean carrier and/or carrier rail.

Syringe Movement

Problem	Possible Cause	What To Do
Syringe position error.	Syringe movement is blocked.	Ensure the 26-pin high-density cable shipped with the Syringe is connected to the MultiFlo FX's rear panel. Contact BioTek TAC.
	Syringe piston not seated all the way to the bottom before fastening set screw.	Reinstall the syringe piston and syringe head.

Peri-pump Troubleshooting

Problem	What To Do
Fluid stream missing wells	Check Tip Holder, make sure it is properly seated in the dispense arm. Select the correct Plate Type .
Fluid splashing out of the wells	Select the correct Plate Type . Reduce the Flow Rate . Lower the Dispense Height .
Uneven dispensing	Make sure all cassette components are properly seated in their respective positions. Tips are clogged. (See Unclog the Dispense Tips on page 194.) Recalibrate the Peri-pump Dispense Cassette on page 211. Replace Peri-pump Dispense Cassette Tubing on page 210.
Dispenser skipping columns	Check/define the plate map, i.e. See also Advanced Dispense Options for Peri-pump.
Tips clogging	Filter the dispense fluid to 50 microns before dispensing. Replace the tubing.
Viscous fluids sticking to tips	Vary the Flow Rate : experiment with different flow rates to determine which setting best forces fluid to break from the tip.
Cannot communicate with computer	Check the cabling. Select the correct COM Port. Turn on dispenser; display Main Menu.
Foaming in the	Reduce the dispense step's Flow Rate .

Problem	What To Do
wells	
Dispenser crashing into plate	Increase the Dispense Height/Z-axis for the Syringe dispenser or Peri-pump. Increase the Plate Clearance Height .

Washer Troubleshooting

Review these suggestions to correct problems your washer is having:

- [Fluid Aspiration below](#)
- [Fluid Delivery on page 280](#)
- [Fluid Leakage on page 282](#)

Microplate Carrier Movement

Problem	Possible Cause	What To Do
Aspiration tubes not entering wells correctly.	Microplate not properly seated or strips not level.	Reseat microplate in carrier or strips in holder. Make sure the carrier is clean. Try a different microplate or strip holder. If the problem is unresolved, the carrier may have to be realigned. Contact BioTek TAC.
	Aspirate tubes position is too wide for a movement.	Change the horizontal, X- or Y-axis aspirate position in the protocol.
	Aspirate tubes bent.	Contact BioTek TAC.
Cell layer disruption	Fluid sloshing in wells disturbs cells	Slow down the plate carrier speed: set the Plate Carrier Speed in the Instrument utilities to "Slow."

Fluid Aspiration

Problem	Possible Cause	What To Do
Poor or uneven aspiration.	Insufficient or no vacuum.	Firmly seat the waste bottle cover. Ensure tubing is connected properly.
		Check all external tubing and in-line filter for kinks or clogs. If you are using an in-line vacuum

Problem	Possible Cause	What To Do
		filter, it may need to be replaced.
		With the vacuum pump on, remove the muffler, if installed, from the back of the module. Put your finger over the port; if there is no vacuum, contact BioTek TAC.
	Clogged aspiration tubes on the washer manifold.	Clean the Washer Manifolds
	Aspirate height adjustment too high or too low.	Make sure the microplate carrier is level.
	Vacuum pump failure.	Change the aspiration height (Z-axis position) in the protocol. Similarly, make sure the Magnet Adapter Height offset is disabled or not too high.
Uneven aspiration of water buffer. Some wells left full.	No surfactant in the buffer, such as Tween [®] 20.	Contact BioTek TAC.
	Protocol settings not optimized.	Add surfactant to the buffer. If this is not possible, continue below.
	Aspiration tubes not properly positioned horizontally in wells.	Optimize protocols to improve evacuation on page 101
	Microplate not level in carrier, or strips not level in holder.	If none of the tubes are bent, try adjusting the horizontal aspirate position (X-/Y-axis) in the protocol. Reseat microplate in carrier or strips in holder. Make sure the carrier is clean. Try a different microplate or strip holder. If the problem is unresolved, the carrier may have to be realigned. Contact BioTek TAC.
Too much residual left in wells after aspiration.	Clogged vacuum filter.	If you are using an in-line vacuum filter (PN 48146), the filter may need to be cleaned or replaced.
	Waste bottle cover not properly sealed or fittings not properly connected.	Firmly seat the waste bottle stopper. Make sure tubing is connected properly.
	Manifold out of alignment or not moving freely.	Check for obstructions. If none are found, contact BioTek TAC.
	Protocol requires	Optimize protocols to improve evacuation on

Problem	Possible Cause	What To Do
	optimization.	page 101 .
	Aspirate tubes are bent.	Gently attempt to straighten the tubes using your fingers. Contact BioTek TAC if the tubes remain bent.

Fluid Delivery

Problem	Possible Cause	What To Do
Unable to dispense fluid.	Inlet tube not connected.	Make sure all tubing is connected properly. Check all external tubing for kinks or clogs.
	Clogged valve	Run Quick Prime several times, to try to unclog valve.
	Clogged dispense tubes on the washer manifold.	Clean the Washer Manifolds
	Check-valve flow direction is incorrect.	Make sure the flow-direction arrows on the check valves match the actual flow direction.
	Check-valves are stuck closed.	Clean or replace the check-valves. See Clean or Replace the Check Valves on page 204 .
	No wash or rinse fluid.	Fill bottles with appropriate fluid. Ensure bottles are clean and do not contain particles or organic material.
Unable to dispense fluid.	System not primed. Large air pockets in tubing.	Run W-DAY_RINSE multiple times.
	Insufficient suction, clogged tubing, or faulty valve.	Perform Washer Maintenance ; If the problem persists, contact BioTek TAC.
Plate overfills (floods).	Dispense height too high. The aspirate tubes are too far above the wells to prevent overflow.	Lower the dispense height (Z-axis position) in the protocol.
	Dispense flow rate too low.	Define a higher dispense Flow Rate in the protocol.
	Aspiration tubes hit	Manifold may not be properly seated or mounted.

Problem	Possible Cause	What To Do
	bottom of trough during Prime or Maintenance.	Contact BioTek TAC.
	In-line vacuum filter plugged.	Replace or remove the in-line vacuum filter.
	Loose covers on waste bottle.	Firmly tighten waste bottle cover.
	Dispense rate too fast for volume selected.	Specify slower dispense Flow Rate or lower volume.
	Faulty vacuum pump.	Contact BioTek TAC.
	Insufficient or no vacuum.	Firmly seat the waste bottle cover. Check all external tubing for kinks or clogs. When the program begins, you should be able to hear the vacuum pump turn on. If it is not turning on, contact BioTek TAC. If the vacuum pump turns on, remove the vacuum tubing from the back of the instrument and put your finger over the port. If there is no vacuum, contact BioTek TAC.
Uneven dispensing of fluid; wells not filled.	Clogged dispense tubes on the washer manifold.	Clean the Washer Manifolds
	Manifold or tubing not adequately primed.	Run W-DAY_RINSE once or twice.
	Dispense flow rate too low.	Define a higher dispense Flow Rate.
	Microplate aspiration height adjustment too high or too low.	Change the aspirate height (Z-axis position) in the protocol.
Dripping dispense tubes	Dispense tubing routed incorrectly.	Connect the fluid supply bottle tube to the bottom port of the syringe pump. Contact BioTek TAC if the problem persists.

Fluid Leakage

Problem	Possible Cause	What To Do
Fluid leaking from manifold.	Defective seals.	
	Aspiration tubes only: vacuum too low.	<p>Check waste connector tubes; make sure they are properly connected.</p> <p>If you are using an in-line vacuum filter, check the filter for clogging, and replace if necessary.</p> <p>Check seal of waste bottle cover.</p> <p>Check for air leaks in the waste tubing and bottle.</p> <p>Use a slower Aspiration Travel Rate.</p> <p>Enable Continuous Vacuum: During Protocol (Instrument>Washer)</p>
	Uneven (not level) surface.	Make sure the washer sits on a perfectly level surface.
Fluid leaking from underneath the washer module.	Defective tubing connector or inlet tubing.	Contact BioTek TAC.
	Leaking valve or syringe seal.	Contact BioTek TAC.
Fluid leaking from external tubing connector.	Defective connector.	Replace connector.
	Worn tubing.	Replace tubing or cut back tubing one inch (to remove worn section).

Error Codes

A listing of potential error codes and possible solutions for resolving them.

System Error Codes	284
MultiFlo FX Software Error Codes	294

System Error Codes

Most of these error conditions require technical expertise to correct. Error code 306 and few other exceptions to this rule are listed with remedies in the [Troubleshooting](#) section. A few other errors may be caused by an obvious obstruction to a device's movement or insufficient fluid in a supply vessel. Fix these kinds of errors and restart your instrument to give it an opportunity to clear the error code.

[Contact BioTek Technical Assistance Center \(TAC\)](#) for assistance.

Code	Message	What to do
100	Task was aborted	Restart instrument if this message is unexpected.
210, 220	Carrier X motor didn't find home opto sensor transition Carrier X motor didn't find autocal jig opto sensor transition	Clean the plate carrier, rails, and glide strips, using mild detergent and hot water, 70% isopropyl alcohol or ethanol. Restart the instrument. If the error occurs again, contact BioTek TAC.
211, 221	Carrier Y motor didn't find home opto sensor transition Carrier Y motor didn't find autocal jig opto sensor transition	Run self test. If error reoccurs, contact BioTek TAC.
212, 222	Dispense head motor didn't find home opto sensor transition; Dispense head motor didn't find autocal jig opto sensor transition	Run self test. If error reoccurs, contact BioTek TAC.
213	Secondary Peri-pump motor didn't find home opto sensor transition,	Run self test. If error reoccurs, contact BioTek TAC.
214	Syringe A motor didn't find home opto sensor transition	Run self test. If error reoccurs, contact BioTek TAC.
215	Syringe B motor didn't find home opto sensor transition	Run self test. If error reoccurs, contact BioTek TAC.
216	Peri-pump motor didn't find home opto sensor transition	Run self test. If error reoccurs, contact BioTek TAC.

Code	Message	What to do
217	Strip washer syringe motor didn't find home opto sensor transition	Run self test. If error reoccurs, contact BioTek TAC.
218, 228	Aspiration head motor didn't find home opto sensor transition Aspiration head motor didn't find autocal jig opto sensor transition	Run self test. If error reoccurs, contact BioTek TAC.
219, 229	RAD Y-axis motor didn't find home opto sensor transition RAD Y-axis motor didn't find autocal jig opto sensor transition	Run self test. If error reoccurs, contact BioTek TAC.
220	Carrier X motor didn't find autocal jig optical sensor transition.	Service Only. Contact BioTek TAC.
221	Carrier Y motor didn't find autocal jig optical sensor transition.	Service Only. Contact BioTek TAC.
300	Carrier X motor interlock safety switch open	Service Only. Contact BioTek TAC.
301	Carrier Y motor interlock safety switch open	Service Only. Contact BioTek TAC.
302	Dispense head motor interlock safety switch open	Service Only. Contact BioTek TAC.
303	Secondary Peri-pump motor interlock safety switch open	Service Only. Contact BioTek TAC.
304	Syringe A motor interlock safety switch open	Service Only. Contact BioTek TAC.
305	Syringe B motor interlock safety switch open	Service Only. Contact BioTek TAC.
306	Peri-pump Pump Cover is open	Close the pump cover door and rerun the protocol.
307	Strip washer motor interlock safety switch open	Service Only. Contact BioTek TAC.
308	Aspirate head motor interlock safety switch open	Service Only. Contact BioTek TAC.

Code	Message	What to do
309	RAD Y-axis motor interlock safety switch open	Service Only. Contact BioTek TAC.
400	Carrier X motor failed positional verify	Run self test. If error reoccurs, contact BioTek TAC.
401	Carrier Y motor failed positional verify	Run self test. If error reoccurs, contact BioTek TAC.
402	Dispense head motor failed positional verify	Run self test. If error reoccurs, contact BioTek TAC.
403	Secondary Peri-pump motor failed positional verify	Service Only. Contact BioTek TAC.
404	Syringe A motor failed positional verify	Service Only. Contact BioTek TAC.
405	Syringe B motor failed positional verify	Service Only. Contact BioTek TAC.
406	Peri-pump motor failed positional verify	Service Only. Contact BioTek TAC.
407	Strip washer syringe motor failed positional verify	Service Only. Contact BioTek TAC.
408	Aspirate head motor failed positional verify	Service Only. Contact BioTek TAC.
409	RAD Y-axis motor failed positional verify	Service Only. Contact BioTek TAC.
600-609	Specified motor currently in use	Service Only. Contact BioTek TAC.
700 - 70F	Invalid motor number specified	Service Only. Contact BioTek TAC.
900	Calibration failed. The measured or calculated autocal value is out of tolerance	Service Only. Contact BioTek TAC.
A00	Invalid plate type selected	The currently selected plate type is not supported with the currently installed or requested hardware. If this is not the case, contact BioTek TAC.

Code	Message	What to do
C01	Configuration or autocal data missing	Service Only. Contact BioTek TAC.
C02	Checksum mismatch -calculated checksum didn't match saved checksum	Service Only. Contact BioTek TAC.
C03	Configuration parameter out of range	Service Only. Contact BioTek TAC.
1001	Bootcode powerup checksum test failed	Contact BioTek TAC.
1002	Unknown error in bootcode	Contact BioTek TAC.
1003	Bootcode page program error	Contact BioTek TAC.
1004	Bootcode block size error (not 256)	Contact BioTek TAC.
1005	Invalid processor signature (not 1280,1281,2560,2561)	Contact BioTek TAC.
1006	Bootcode memory exceeded	Contact BioTek TAC.
1007	Invalid slave port	Contact BioTek TAC.
1008	Invalid response from slave	Contact BioTek TAC.
1009	Invalid processor detected	Contact BioTek TAC.
1010	Checksum error downloading basecode	Contact BioTek TAC.
1250	Internal RAM test error on the UI processor	Contact BioTek TAC.
1251	Internal RAM test error on the MC processor	Contact BioTek TAC.
1260	Stack test error on the UI	Contact BioTek TAC.
1261	Stack test error on the MC	Contact BioTek TAC.
1300	Invalid syringe selection	Contact BioTek TAC.

Code	Message	What to do
1301	Syringe module not connected	Make sure the Syringe module is correctly connected using the new BioTek-provided serial cable.
1302	Syringe initialization error	
1303	Syringe sensor not cleared error	
1304	Invalid syringe dispense volume	See error 1308 below.
1305	Invalid syringe operation	Contact BioTek TAC.
1306	FMEA error on syringe A	Contact BioTek TAC.
1307	FMEA error on syringe B	Contact BioTek TAC.
1308	Invalid Syringe pre-dispense volume	Protocol may have been written for a different type of dispense manifold. Make sure the Instrument Settings represent the installed hardware. Modify the protocol to match.
1309	Invalid Syringe prime volume	
1310	Invalid Syringe manifold	
1350	Peri-pump (PP) invalid dispense volume	Contact BioTek TAC.
1351	PP invalid cassette type	Change the cassette type to match the protocol requirement and rerun the protocol.
1352	PP invalid pre-dispense volume	Contact BioTek TAC.
1353	Multiple required cassettes	Make sure every Peri-pump step in the protocol calls for the same cassette type. A conflict was found.
1354	PP pump cover (safety door) open	Close the pump cover door and rerun the protocol.
1355	PP not installed	If you are trying to run a Secondary Peri-pump, check the cabling in the back of the instrument. Otherwise Contact BioTek TAC.
1356	PP Invalid dispense position	Contact BioTek TAC.
1357	PP two dispensers are expected	Contact BioTek TAC.
1358	PP Half UL not supported	0.5 μ L Peri-pump dispensing is not supported on this instrument.

Code	Message	What to do
1359	RAD Technology is not supported	RAD single-tube and 8-to-1 cassettes are not supported on this instrument. If the hardware is properly installed and all cables are currently plugged in, contact BioTek TAC.
1401	The waste bottles should be emptied before continuing	Empty the waste bottles and rerun the protocol.
1404	Plate type restricted	This instrument model or the requested device does not support the selected plate type. Edit the protocol to change the plate type .
1405	Z-axis out of range	The requested travel/dispense height cannot be reached. The conflict may be caused by a combination of variables, plate type, Plate Clear or other height settings. Review the protocol parameters and instrument settings to identify a correction.
1407	Invalid step type	The protocol may have been created for a different instrument, it is not compatible with this instrument.
1408	Invalid plate geometry	Contact BioTek TAC.
1409	Invalid plate carrier type	Contact BioTek TAC.
1412	Tip clearance error	Contact BioTek TAC.
1413	AutoPrime in progress	Contact BioTek TAC.
1414	AutoPrime aborted	Contact BioTek TAC.
1415	AutoPrime value out of range	Contact BioTek TAC.
1430	Strip washer syringe pump FMEA	Contact BioTek TAC.
1431	Strip washer aspirate manifold not installed	Contact BioTek TAC. Instrument basecode is not correctly configured.
1432	Strip washer module not connected	Plug in the strip washer: connect the washer module to the MultiFlo FX using the supplied serial cable.
1433	Bad step pointer used to calculate Z-axis positioning	Contact BioTek TAC.

Code	Message	What to do
1440	RAD module not connected.	Check the cables that connect the external Peri-pump and the RAD module to the back of the instrument. Make sure they are correctly plugged in.
1441	RAD 8-to-1 bulk-dispensing cassette Chute Height invalid.	Change the Peri-pump advanced instrument setting for Chute Height.
1503	Dispense volume error	Contact BioTek TAC.
1506	The requested carrier Y-axis position is out of range	Contact BioTek TAC.
1508	Pre-dispense volume error	The specified Pre-dispense volume is invalid for this plate type. Edit the protocol.
1512	Invalid plate type	The specified plate type is not supported with the current hardware.
1513	Plate type - manifold conflict	Change the Plate Type to one supported by the manifold. Or, check the Instrument Settings and make sure they match the physical hardware: Get settings from instrument.
1600-160C	The onboard storage space allocated for this function has been used up	Use the LHC " Manage Memory " control to reallocate space.
160D	Not a valid step	Contact BioTek TAC.
2400	Parameter limit exceeded	Contact BioTek TAC.
4000	Program locked so operation denied	Contact BioTek TAC.
4010	Program cannot be erased so delete denied	Contact BioTek TAC.
4020	Bad checksum when reading program from EEPROM	Contact BioTek TAC.
4030	Program not found	Contact BioTek TAC.
4040	Can't save program because no space available	Contact BioTek TAC.
4050	Program run canceled by user	Restart instrument if this message is unexpected.

Code	Message	What to do
8100	Communications NAK	Contact BioTek TAC.
	In this 8100 series of communications error codes, the third number, e.g. 81n1, n identifies the source: 0 between PC and instrument; 1 between UI and MC; and 2 between BioStack and instrument. For example, 8101 is timeout error in communication between the instrument and the PC, and 8111 is a timeout error in communication between the internal controllers, UI and MC.	
8101 8111	Timeout while waiting for serial message data	Contact BioTek TAC.
8102	Instrument busy and unable to process message	Contact BioTek TAC.
8103	Receive buffer overflow error	Contact BioTek TAC.
8104	Checksum error	Contact BioTek TAC.
8105	Invalid structure type in byMsgStructure header field	Contact BioTek TAC.
8106	Invalid destination in byMsgDestination header field	Contact BioTek TAC.
8107	Request object received not supported by instrument	Contact BioTek TAC.
8108	Message Body size exceeds max limit	Contact BioTek TAC.
8109	Max number of requests currently running and cannot run the latest request	Contact BioTek TAC.
810A	No request running when response request issued	Contact BioTek TAC.
810C	Response for outstanding request not ready yet	Contact BioTek TAC.
810D	To communicate with the LHC, the instrument must be at its main menu	The LHC can only talk to the instrument when its main menu is displayed. When the instrument is busy, for example when AutoPrime is running, press the Stop button on the keypad, if desired, to end the current process and return to the main menu.
810E	One or more request parameters are not valid	Contact BioTek TAC.

Code	Message	What to do
810F	The command was received while the software was not ready to accept that command	Contact BioTek TAC.
A00	Invalid plate type requested	Service Only. Contact BioTek TAC.
A100 - A10F	Software device not available	Service Only. Contact BioTek TAC.
A200	Version strings for multiple microprocessors do not match	Service Only. Contact BioTek TAC.
A301	+5v logic power supply level error	Service Only. Contact BioTek TAC.
A302	+24v system/motor power supply level error	Service Only. Contact BioTek TAC.
A303	+42v Peri-pump motor power supply level error	Service Only. Contact BioTek TAC.
A305	+42v Secondary Peri-pump motor power supply level error	Service Only. Contact BioTek TAC.
A400	Malloc failed	Service Only. Contact BioTek TAC.
A500	Multiple tasks attempted to use display simultaneously	Service Only. Contact BioTek TAC.
A600	Serial EEPROM access error	Service Only. Contact BioTek TAC.
A700	Motor truncation error: X axis. Carrier X-axis motor steps are being truncated based on the profile	Service Only. Contact BioTek TAC.
A701	Motor truncation error: Y axis. Carrier Y-axis motor steps are being truncated based on the profile	Service Only. Contact BioTek TAC.
A702	Motor truncation error: Dispense head motor steps are being truncated based on the profile	Service Only. Contact BioTek TAC.

Code	Message	What to do
A703	Motor truncation error: external /secondary Peri-pump motor steps are being truncated	Service Only. Contact BioTek TAC.
A704	Motor truncation error: Syringe A motor steps are being truncated	Service Only. Contact BioTek TAC.
A705	Motor truncation error: Syringe B motor steps are being truncated	Service Only. Contact BioTek TAC.
A706	Motor truncation error: internal/primary Peri-pump motor steps are being truncated	Service Only. Contact BioTek TAC.
A707	Motor truncation error: strip washer syringe motor steps are being truncated	Service Only. Contact BioTek TAC.
A708	Motor truncation error: strip washer aspirate head motor steps are being truncated	Service Only. Contact BioTek TAC.
AA30 - AA38	Motor profile errors	Service Only. Contact BioTek TAC.
AD00	Stack overflow error	Service Only. Contact BioTek TAC.
AF00	Communication error between UI and MC	Service Only. Contact BioTek TAC.

MultiFlo FX Software Error Codes

Generally, these errors are caused by protocol parameters that conflict with the instrument's onboard settings. The protocol may have been originally created for a different hardware configuration, the 192-tube wash manifold instead of the 96-tube, for example.

Error Code	Description	Help
6000	General communication error during download.	See Communication Errors
6001	COM port created by USB converter no longer active.	See Communication Port
6002	Invalid basecode part number; instrument is not MultiFlo FX.	Service Only. Contact BioTek TAC.
6003	Invalid Basecode Data Version; basecode needs to be updated.	Contact BioTek to obtain latest basecode.
6004	No rows are selected for the specified plate type.	Modify the protocol to select a row.
6005	Invalid row selection value (must be 0 or 1).	Contact BioTek TAC.
6006	This instrument can only process 96-well plates.	The protocol may have been created for another instrument, change the plate type or select another protocol.
6007	This instrument can only process 1536-well plates.	
6008	The 8-tube Syringe Manifold can only be used with 96-well plates.	Mismatch between installed hardware and protocol parameters: change the plate type or correct the instrument settings to match the currently installed hardware.
6009	The 96-tube single wash manifold can only be used with 96-well plates.	
6010	The data is invalid or out-of-range.	Service Only. Contact BioTek TAC.
6011	This step type cannot be downloaded.	Review the limitations to transferring protocols to the instrument, See the LHC Help Topic: <i>Transferring Protocols</i> .

Error Code	Description	Help
6012	Illegal characters in protocol name.	See the LHC Help topic: <i>Define a Protocol</i> .
6013	The protocol name length must be 16 characters or less.	
6014	A 1536 well plate is not supported by this instrument.	Service Only. Contact BioTek TAC.
6015	The specified volume exceeds the cassette maximum limit.	Modify the volume or change the cassette type .
6016	The volume is out-of-range.	Modify the volume or change the cassette type.
6017	Invalid flow rate.	Learn about the Syringe Dispense Step
6018	Invalid number of pre-dispenses.	Service Only. Contact BioTek TAC. These codes indicate an unexpected software error that cannot be fixed without BioTek support.
6019	Invalid horizontal dispense position.	
6020	Invalid dispense height.	
6021	Invalid plate clear height.	
6022	Invalid column selection value (must be 0 or 1).	
6023	Invalid protocol step type.	
6024	The Definition String contains invalid data.	
6025	Manifold conflict between protocol requirements and instrument configuration.	Change the Washer Manifold or change the Instrument Setting.
6026	Valve module conflict between protocol requirements and instrument configuration.	Make sure the Buffer Switching setting matches your instrument; see Instrument Settings .
6027	Syringe module conflict between protocol requirements and instrument configuration.	Make sure the Syringe dispenser setting matches your instrument: see Instrument Settings .
6028	Filter washer conflict between protocol requirements and instrument configuration.	Service Only. Contact BioTek TAC.
6029	Required cassette does not match	Change the cassette type to match the

Error Code	Description	Help
	installed cassette. Using RAD technology cassettes increases the chance of getting this error. Be as precise as possible when using this feature.	protocol requirement and rerun the protocol.
6030	Invalid cassette type was specified.	Service Only. Contact BioTek TAC.
6031	Cannot use a 96-well plate with a 192-tube manifold.	Modify the Plate Type or Change the Washer Manifold.
6032	Downloading Protocols is not supported.	Service Only. Contact BioTek TAC.
6033	This step is not supported for 1536-well plates.	Fix the plate type or the Instrument Settings. A conflict between the plate type and installed hardware devices has been detected. Change the Plate Type to one supported by the washer/dispenser. Or, click the Instrument Settings link and make sure they match the physical hardware: Get settings from instrument.
6034	The 32-tube Syringe Manifold is required for 1536-well plates.	
6035	The 16-tube Syringe Manifold is required for 96- and 384-well plates.	
6036	The 128-tube Washer Manifold is required for 1536-well plates.	
6037	The 128-tube Washer Manifold can only be used for 1536-well plates.	
6038	This step only applies to 1536-well plates.	Fix the plate map (selected columns to dispense to). A protocol parameter may have been changed after a partial plate dispense was defined.
6039	Conflicting column selection.	
6040	Invalid baud rate	Service Only. Contact BioTek TAC. These codes indicate an unexpected software error that cannot be fixed without BioTek support.
6041	Invalid data bits selection	
6042	Invalid stop bits selection	
6043	Invalid parity selection	

Error Code	Description	Help
6044	Serial port error	Fix the COM port setting. Check the cabling. Click the Port link and use the drop-down menu to see all active ports. Customize the Predefined Protocols to avoid this error in future. When controlling the BioStack with the LHC, make sure the instrument's BioStack setting is Manual .
6045	Serial write error	
6046	Serial read error	
6047	Checksum error	Contact BioTek TAC.
6048	Serial NAK error	Make sure the COM port setting is correct and the cable is properly connected. Restart the instrument. If error reoccurs, contact BioTek TAC.
6049	Excess data, or not enough data, received.	To correct these errors: <ul style="list-style-type: none"> • Reset the instrument. • Check cables, plug in only one communication cable at a time: USB or serial. • Try running a different protocol. If error reoccurs, contact BioTek TAC.
6050	Invalid message header	
6051	Invalid message object	
6052	Invalid message body size	
6053	Serial message timeout	
6054	Port handle error	
6055	Read timeout value is invalid.	
6056	Unauthorized to open the COM port.	Make sure the COM port setting is correct and the cable is properly connected. Restart the instrument. If error reoccurs, contact BioTek TAC.
6057	Out-of-range parameter for the open port function.	
6058	Unable to open the COM port.	
6059	Unable to clear the transmission buffer.	
6060	Unable to close the port.	
6061	Port is no longer available.	
6062	Unhandled exception while transmitting message.	Contact BioTek TAC
6063	The selected plate type is not allowed with this protocol step.	Modify the protocol to change the plate type.

Error Code	Description	Help
6064	The protocol specifies more Peri-pumps than are available.	The protocol may have been created for a different instrument. Make sure the instrument settings match the current instrument and modify the protocol.
6065	Too few data bytes received from the instrument.	Contact BioTek TAC.
6067	The type of Syringe pump is not compatible with the syringe manifold.	Contact BioTek TAC.
6070	Invalid Syringe specified.	Service Only. Contact BioTek TAC. These codes indicate an unexpected software error that cannot be fixed without BioTek support.
6071	Invalid number of syringe prime cycles.	
6072	Invalid syringe Aspirate Delay value.	
6073	Invalid X-axis offset value.	
6074	Invalid Y-axis offset value	Service Only. Contact BioTek TAC. These codes indicate an unexpected software error that cannot be fixed without BioTek support.
6075	Invalid Z-axis offset value	
6080	Invalid Peri-pump prime duration	Service Only. Contact BioTek TAC. These codes indicate an unexpected software error that cannot be fixed without BioTek support.
6085	Invalid minutes:seconds value	
6086	Invalid hours:minutes value	
6087	'Move carrier home' is required when duration exceeds 1 minute.	Contact BioTek TAC

Error Code	Description	Help
6088	Invalid Shake/Soak options selected	<p>Service Only. Contact BioTek TAC.</p> <p>These codes indicate an unexpected software error that cannot be fixed without BioTek support.</p>
6089	Invalid Shake Intensity selected	
6090	Invalid Washer buffer selected	
6091	Invalid Washer Aspirate Delay value	
6092	Invalid Washer Aspirate Travel Rate value	
6093	Invalid Wash Cycles value	
6094	Invalid Wash format selected	
6095	Invalid Wash Sectors selected	
6096	Wash Aspirate Delay value is required.	
6097	Syringe Dispense Volume must be an integer.	
6098	Peri-pump cannot run with the pump cover open.	Close the pump cover door and rerun the protocol.
6099	Peri-pump assembly not installed.	Physically install the Peri-pump and/or make sure the instrument settings reflect the current state.
6160	Strip washer required to perform this step, but not installed.	Make sure the protocol you are trying to run is supported by your instrument's devices.
6161 6162	Strip washer manifold and plate type are incompatible. Strip washer doesn't support this plate type.	Make sure the specified plate type matches the installed manifold and the instrument's manifold setting correctly identifies the installed manifold.
6165	This Peri-pump does not support single well dispensing.	An external Peri-pump is required for RAD technology cassettes. Edit the protocol to use the correct Peri-pump, i.e. protocols designed for a Primary pump cannot be run on a Secondary pump.
6166	This instrument does not support RAD technology dispensing.	Make sure the protocol you are trying to run is supported by your instrument's devices.

Error Code	Description	Help
6167-6170	The Syringe manifold does not support the plate type.	Make sure the specified plate type matches the installed manifold and the instrument's manifold setting correctly identifies the installed manifold.
6171	The installed RAD cassette does not support this plate type.	Either use a supported plate type, correct the instrument's cassette type setting or edit the protocol.

Index

<hr/> 1 <hr/>	
1536-well plates.....	98, 134, 165, 168
1536F.....	134
<hr/> 5 <hr/>	
500 nL.....	105, 155-156
<hr/> 6 <hr/>	
6-,12-,24-,48-well plates.....	134
<hr/> 9 <hr/>	
96 Well Cluster Tubes (Corning).....	136
<hr/> A <hr/>	
Accessories.....	13
Aliquot.....	153, 222
Aspirate fluid.....	101
how to delay.....	144
travel rates.....	112
Uneven aspiration.....	279
Assays	
Biomagnetic separation.....	145
Cellular.....	3, 142
ELISA.....	3
Autoclave components.....	190
AutoPrime.....	178-179
Syringe dispenser.....	185-186
AutoPrime Interval.....	179
<hr/> B <hr/>	
BioStack	
Create a protocol.....	125
How to configure/operate.....	124
Plates with lids.....	126, 171
BioStack errors.....	272
BioTek's Customer Resource Center...26	
Bottle holder.....	60
Bottom Wash.....	114
BSA.....	187
Buffer Switching.....	4
<hr/> C <hr/>	
Calibration Data.....	167, 212
Carrier setting.....	169
Cassette	
Calibration.....	210
Diagram.....	54
RAD technology.....	58
Replacement tubing.....	13
Shorten tubing.....	61
Cassette Life.....	19, 22, 199
Cassette Types.....	19
Cell Wash.....	111, 142
aspirate rate.....	112
Strategy to preserve cells.....	143
Center holder.....	54
Change	
Cassette type.....	76
Fluids.....	142
Syringe Manifold.....	75, 165
Chemiluminescence.....	3
Cleaning.....	185, 189, 208
Removing proteins.....	187
COM Port.....	73, 120
CW+ Control.....	142
<hr/> D <hr/>	
Dead Volume.....	7, 19, 61, 101, 161
Peri-pump.....	99
Decontaminate.....	205
Autoclave.....	190
Manifold and tubing.....	208
Deionized water.....	175, 189
Delay	
Protocol.....	117

Residual too high.....	279
Resize.....	141
window.....	141
RIA.....	3
Robotics integrators.....	125

S

Self-test.....	218
Serial port.....	72, 125, 273
Shake intensity.....	116
Shake/Soak parameters.....	116
Shipping	
Prepare for.....	210
Size and weight.....	18
Skip columns/rows.....	138
Soak.....	116, 184-185
manifold tubes.....	185-186
Soak step.....	116
Solutions	
Syringe qualification.....	236
Special plate carrier.....	136
Special plate types.....	9, 134
Specifications.....	18
Sterilize	
autoclave.....	190
Stop	
Control start-stop.....	116, 118
Storage.....	210
Strip Washer.....	20, 23
Syringe Dispense Step.....	163
Syringe Dispenser	
Autoclavable vs. non-autoclavable.....	167
Fixing problems.....	273
How to set up.....	68
Recommended prime volumes.....	101
Syringe Dispenser Settings.....	166
Syringe Manifold	
Change.....	75, 165
Syringe Prime Step.....	161
Syringe Settings.....	75, 165
System Error Codes.....	284

T

Test solutions.....	251
Test Solutions	
Syringe.....	236
Tests	
which tests to perform.....	219
Theory of operation.....	153
Timer.....	118
Tip guard.....	54
Tip holder.....	54
Tip priming.....	113
Transfer protocols.....	170
Troubleshooting.....	272
Instrument Error Codes.....	284
LHC Error Codes.....	294
Peri-pump problems.....	277
Syringe problems.....	273
Washer problems.....	278
Tube organizer.....	54
Tube tensioner.....	54

U

Upload protocols.....	170
USB.....	272
Use BioStack.....	125

V

Vacuum	
Low.....	278
Vacuum on based on volume.....	144
Valve module, external	
Compatibility with washer models.....	4
Verification	
instrument testing.....	219

W

Wash	
about.....	141
extra turbulence.....	114
Gentle, cell wash.....	142
Magnetic beads.....	145

Washer	
Fixing problems	278
Protocol parameters listing	108
Washer Dispense step	113
Washer Flow Rates	111
Washer Prime step	183
Washer Manifold	
AutoPrime	183
Water.....	175, 189
Well map.....	157

MultiFlo FX Chemical Compatibility

For your own safety and to ensure the MultiFlo FX's long life, follow these guidelines when choosing compounds to use.

❖ **Important:** Avoid continuous contact with harsh chemicals. Best practice is to rinse all components with deionized/distilled water after contact with any strong acid, base, or solvent.

Materials listed as 1-16 in **Table 1** are cross-referenced as headings 1-16 in **Table 2**. Table 1 indicates which component contains the material using **P** for Peri-pump, **S** for the dual Syringe dispensers and **W** for the washer module.

Table 1: Material Where Used

#	Material	Where Used
1	316 Stainless Steel	P Steel dispense tips, pump rollers, carrier rails, cassette bolts
		S Dispense tubes, syringe piston, cylinder
		W head and fittings, check valve spring,
2	Aluminum	Instrument main structural plate
		P Center Holder, Tube Tensioner, pump head, dispense arm
		W Aspirate arm
3	Borosilicate Glass	S Syringe cylinder, supply bottles (autoclavable models only)
4	Brass	P Threaded inserts in Center Holder and Tip Holder
5	EP (Ethylene Propylene)	S Check-valve o-rings (organic solvent
		W tubing set)
6	ETFE (Ethylene tetrafluoroethylene)	S Manifold fitting
7	Noryl (PPO)	S Syringe cylinder (non-autoclavable models
		W only)
8	Polycarbonate	W Plate carrier
		P Plate positioning dog, peristaltic pump cover latch
9	Polyethylene	S Supply Bottle
		W
10	Polypropylene	S Outlet fitting, fittings in bottles, inline
		W fittings
		S Bottle cap and fittings, check valves
		W (organic solvent tubing set)
		P Molded dispense tips
11	Polystyrene	Assay plates
		P Peristaltic pump cover

P = Peri-pump
S = Syringe dispensers
W = Washer

12	PTFE (polytetrafluoroethylene)	S W	Syringe seal
13	CPVC (Polyvinyl chloride)	S W	Manifold
14	Ryton® PPS	P S W	Tube Organizer, priming trough, priming trough insert, RAD 8-to-1 chute Manifold, manifold plugs, priming trough insert
15	Silicone	P S W	Tubing Tubing, manifold o-rings, check valve o-rings
16	Ultem (polyetherimide)	P S W	Center Holder, Tube Tensioner, Tip Holder Check-valves

Note: Proper use of vaporized hydrogen peroxide (also known as hydrogen peroxide vapor, HPV, and by the trademarked name VHP) in non-condensing mode is an approved method of decontaminating the instrument.

Table 2: Chemical Compatibility

Key	1	2	3	4	5	6	7	8	9	10	11	12	13	14	15	16
A - No effect	316 S.Steel	Aluminum	Borosilicate Glass	Brass	EP (Ethylene	ETFE (Ethylene tetrafluoroethylene)	Noryl (PPO)	Polycarbon.	Polyethylene	Polypropyl.	Polystyrene	Ptfe (Teflon)	CPVC (chlorinated polyvinyl chloride)	Ryton	Silicone	Ultem
B - Slight effect																
C - Moderate effect																
D - Severe effect																
ND - No data																

Chemical	1-16 represent Materials listed above and in the Where Used List															
	1	2	3	4	5	6	7	8	9	10	11	12	13	14	15	16
Acetic Acid, 5%	A	B	ND	D	N D	A	A	A	A	A	D	A	D	A	A	A
Acetic Anhydride	A	A	ND	D	A	ND	D	D	C	B	D	A	D	A	A	ND
Acetonitrile	A	B	A	ND	C	A	ND	D	A	A	D	A	D	A	D*	D
Ammonia 10%	A	A	ND	ND	N D	ND	A	D	N D	A	B	A	B	A	D	D
Benzyl Alcohol	B	B	A	ND	B	A	D	ND	A	A	D	A	D	A	A	ND
Chloroform	A	B	A	B	D	A	D	D	D	C	D	A	D	A	D	D
Detergents 1%	A	B	A	ND	A	A	A	A	A	A	A	A	A	A	A	A
Dimethylformamide	B	A	A	ND	B	A	D	D	C	A	D	A	D	A	A	ND
DMSO (Dimethylsulfoxide)	A	A	A	ND	B	C	B	D	A	A	D	A	D	A	C*	D
Ethyl Alcohol 70%	A	A	A	A	A	A	A	B	B	A	A	A	B	A	B	A
Ethylene Oxide	B	D	A	D	C	A	A	C	A	D	C	A	C	D	A	ND
Formaldehyde 37%	A	B	A	A	A	A	A	A	D	A	ND	A	A	A	C	A
Hexane	A	A	A	A	D	A	B	D	A	B	D	A	B	A	D	A
Hydrochloric Acid 20%	D	D	A	D	A	A	A	B	A	B	C	A	A	D	D	A
Hydrofluoric Acid 20%	D	D	ND	ND	C	D	C	D	A	A	ND	A	B	A	D	ND
Hydrogen Peroxide 10%	B	A	A	D	A	A	A	A	A	A	A	A	A	C	A	A
Isopropyl Alcohol 70%	A	A	A	A	A	A	A	A	B	A	A	A	B	A	A	A
Methyl Alcohol 70%	A	A	A	A	A	A	A	B	A	A	ND	A	A	A	A	A
Methylene Chloride	B	C	A	A	N D	A	D	D	D	B	D	A	D	A	D	D
Phosphoric Acid 10%	D	C	ND	D	A	A	A	A	A	A	B	A	B	A	C	A
Propylene Glycol	B	B	ND	ND	N D	ND	ND	B	A	A	A	A	C	A	A	ND
Sodium Chlorate	B	C	ND	ND	N D	A	A	A	N D	A	ND	A	A	A	C	ND
Sodium Hydroxide 20%	B	D	A	B	B	A	A	A	A	A	A	A	A	A	A	A
Sodium Hypochlorite <20%	C	D	A	D	B	A	A	C	A	A	A	A	A	C	B	B
Sodium Hypochlorite 0.5%	B	D	A	D	B	A	A	C	A	A	A	A	A	C	B	A
Sulfuric Acid <10%	B	B	A	ND	A	C	A	A	A	A	A	A	A	A	C	A
Trichloroethylene	B	D	ND	ND	N D	A	D	ND	D	C	D	A	D	A	D	D
Virkon 10%	A	D	A	ND	A	ND	A	A	A	A	A	ND	A	A	A	ND

* Exposure to DMSO and Acetonitrile may cause the silicone tubing to swell, increasing the volume of fluid dispensed. The magnitude of this effect will vary with concentration and exposure. Re-calibration of the cassette may be required.